



**TOGETHER**  
*for a sustainable future*

## OCCASION

This publication has been made available to the public on the occasion of the 50<sup>th</sup> anniversary of the United Nations Industrial Development Organisation.



**TOGETHER**  
*for a sustainable future*

## DISCLAIMER

This document has been produced without formal United Nations editing. The designations employed and the presentation of the material in this document do not imply the expression of any opinion whatsoever on the part of the Secretariat of the United Nations Industrial Development Organization (UNIDO) concerning the legal status of any country, territory, city or area or of its authorities, or concerning the delimitation of its frontiers or boundaries, or its economic system or degree of development. Designations such as “developed”, “industrialized” and “developing” are intended for statistical convenience and do not necessarily express a judgment about the stage reached by a particular country or area in the development process. Mention of firm names or commercial products does not constitute an endorsement by UNIDO.

## FAIR USE POLICY

Any part of this publication may be quoted and referenced for educational and research purposes without additional permission from UNIDO. However, those who make use of quoting and referencing this publication are requested to follow the Fair Use Policy of giving due credit to UNIDO.

## CONTACT

Please contact [publications@unido.org](mailto:publications@unido.org) for further information concerning UNIDO publications.

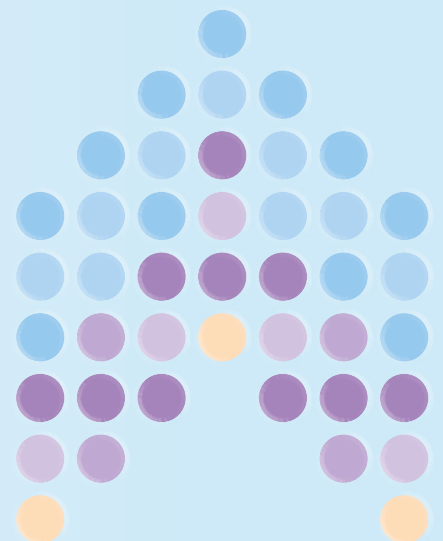
For more information about UNIDO, please visit us at [www.unido.org](http://www.unido.org)



**TOGETHER**  
*for a sustainable future*

1966 - 2016

# MANUAL FOR INDUSTRIAL PUMP SYSTEMS ASSESSMENT AND OPTIMIZATION



Copyright © United Nations Industrial Development Organization, 2016

This publication and any part thereof may be freely quoted and reprinted in any form for educational or non-profit purposes, without special permission from the copyright holder, but acknowledgement of the source is requested. UNIDO would appreciate receiving a copy of any publication containing a quotation or reprint.

No use of this publication may be made for resale or for any other commercial purpose whatsoever without prior permission in writing from the United Nations Industrial Development Organization.

Although great care has been taken to maintain the accuracy of information within this Manual, neither UNIDO nor the authors or contributors assume any legal liability or responsibility for consequences that may arise from the use of the Manual.

Reference herein to any specific commercial product, process, or service by trade name, trademark, manufacturer, or otherwise, does not necessarily constitute or imply its endorsement or recommendation by UNIDO. The views and opinions of authors expressed herein do not necessarily state or reflect those of UNIDO.



## FOREWORD

---

Energy is a fundamental prerequisite for development and economic activity. It is evident, however, that current energy supply and consumption patterns are environmentally unsustainable and must be improved. UNIDO's mandate to promote Inclusive and Sustainable Industrial Development (ISID) aims, inter alia, at decoupling industrial development from unsustainable resource usage and negative environmental impacts. Through ISID, UNIDO is also aligned with the Sustainable Development Goals (SDGs) – including SDG 9 (“Build resilient infrastructure, promote inclusive and sustainable industrialization, and foster innovation”) and SDG 7 (“Ensure access to affordable, reliable, sustainable and modern energy for all”).



As the developing world gradually embarks on industrial growth and participation in global trade, rising energy costs and the foreseen sizeable increase in energy demand make energy efficiency a definite priority. On the one hand, energy efficiency makes good business sense, as it entails cost savings and improvements by optimizing the use of resources and reducing waste. On the other hand, energy efficiency contributes to mitigating the negative impact of energy use and consumption on the environment, both at local and global level; a more resource-conscious approach allows more to be done with less. Among further benefits, energy efficiency leads to improved energy performance, increased operational reliability, strengthened security of supply, and reduced energy price volatility.

Industry is responsible for about a third of global CO<sub>2</sub> emissions. If the world is to meet the climate change mitigation goals set by the international community, industry needs to substantially increase its energy efficiency, and progressively switch to low-carbon and low-emission technologies, including renewable sources of energy.

UNIDO provides a variety of tools to address the immediate challenge of implementing the best available policies, technologies and practices for industrial energy efficiency through knowledge sharing, capacity building, demonstrations, investments and partnerships. UNIDO helps raise the business potential of industry by introducing and enhancing energy management practices and accounting methods. The present Manual for Industrial Pump Systems Assessment and Optimization seeks to provide direction and support to companies seeking to optimize their existing pump systems and an additional knowledge resource for industrial energy efficiency service providers.

**LI Yong**  
**Director General**

## ACKNOWLEDGMENTS

---

This publication was prepared by the UNIDO Industrial Energy Efficiency Division with the financial contribution of the State Secretariat for Economic Affairs of the Swiss Confederation (SECO), the Department for International Development (DFID) of the Government of the United Kingdom, the Department of Energy and the Department of Trade and Industry of the Republic of South Africa and the Global Environment Facility (GEF).

Marco Matteini was the project lead and had the overall responsibility for the design and development of this publication. Pradeep Monga, Director of UNIDO Energy Department, provided essential leadership and inspiration during the whole project.

This Manual for Industrial Pump Systems Assessment and Optimization was authored by Gunnar Hovstadius (Gunnar Hovstadius Consulting) and Steven Bolles (Process Energy Services). Many individuals, organizations, industrial plants and programs contributed significantly and shared valuable resources, time and effort in developing this Manual.

UNIDO and the authors express their sincere gratitude to all of them and in particular to Aimee McKane (Lawrence Berkeley National Laboratory) and Vestal Tutterow (Alliance to Save Energy). Special gratitude is expressed to the following organizations, which provided material used in this manual: U.S. Department of Energy, Oak Ridge National Laboratory, Hydraulic Institute, Pumps and Pumping by Skeet Arasmith, ACR Publications and Centrifugal Pumps, Karassik & McGuire, Kluwer Academic Publishers. Special thanks must also go to Don Casada (Diagnostic Solutions) who developed the PSAT software referred to and presented in this manual.

The manual has been peer reviewed by Stephen Schofield (British Pump Manufacturers Association) and Anibal De Almeida (ISR University of Coimbra).

Khac Tiep Nguyen, James New, Bettina Schreck, Sanjaya Shrestha and Rana Ghoneim from the UNIDO Industrial Energy Efficiency Division provided valuable support during the entire development process. The authors and project lead would finally like to thank Oksana Pavliska and Egbert Mentzingen for editing the manuscript and providing constant support during its preparation.



## ABOUT UNIDO

---

The United Nations Industrial Development Organization (UNIDO) is a specialized agency of the United Nations. Its mandate is to promote and accelerate sustainable industrial development in developing countries and economies in transition and work towards improving living conditions in the world's poorest countries by drawing on its combined global resources and expertise. Since the 2013 Lima Declaration, UNIDO has embarked on a new vision towards Inclusive and Sustainable Industrial Development (ISID) with the purpose of creating shared prosperity for all as well as safeguarding the environment. Furthermore, through ISID, UNIDO addresses all three dimensions of sustainable development: social equality, economic growth and environmental protection. As a result, UNIDO has assumed an enhanced role in the global development agenda by focusing its activities on poverty reduction, inclusive globalization and environmental sustainability.

UNIDO services are based on two core functions: as a global forum, it generates and disseminates industry-related knowledge; as a technical co-operation agency, it provides technical support and implements projects.

UNIDO focuses on three main programmatic areas in which it seeks to achieve long-term impact:

- Advancing economic competitiveness
- Creating shared prosperity
- Safeguarding the environment

### About UNIDO Industrial Energy Efficiency Programme

The UNIDO Industrial Energy Efficiency (IEE) Programme builds on more than three decades of experience and unique expertise in the field of industrial development and technology transfer. It represents a pillar of the Green Industry model that UNIDO promotes. Combining the provision of policy and normative development support services and capacity building for all market players, UNIDO aims at removing the key barriers to energy efficiency improvement in industries and ultimately transforming the market for industrial energy efficiency.

The UNIDO IEE Programme is structured around the following thematic areas:

- Policies and standards – strengthening policy and regulatory frameworks for more sustainable and efficient energy performance in industry.
- Energy management and efficient operation – integrating energy efficiency in day-to-day operations to save energy and reduce GHG emissions.
- Energy efficiency design and manufacturing – accelerating the adoption of new technologies and best practices.

## About the UNIDO Pump Systems Optimization (PSO) Programme

The UNIDO Pump Systems Optimization (PSO) Capacity Building and Implementation Programme consists of three elements: an EXPERT Training, USER Training and a VENDOR Workshop.

The **PSO USER Training** is targeted at facility engineers, operators and maintenance staff of enterprises, equipment vendors and service providers. It is designed to teach how to assess industrial pump systems, identify opportunities for performance improvements and achieve energy/cost savings through proper operation and control, system maintenance, and the appropriate use of pumps.

The **PSO EXPERT Training** is an intensive training delivered by leading international Pump Systems Optimization experts to national energy efficiency experts, service providers, equipment vendors and industry engineers. This training provides more in-depth technical information on assessing performance, troubleshooting and making improvements to industrial pump systems. This training also introduces basic principles for energy efficient design of pump systems and how to successfully sell pump systems improvement projects to management. National EE experts are trained through classroom, on-the-job and coaching by international PSO experts and equipped with expertise, skills and tools (including measuring equipment) required for providing the following services:

- Providing technical assistance to enterprises on pump systems energy assessment and identification, development and implementation of optimization projects
- Conducting PSO USER training and coaching facility personnel for pump systems energy assessment and optimization

The **PSO VENDOR Workshop** is targeted to local pumps and related equipment vendors, suppliers and manufacturers. The workshop is designed to introduce these key market players to PSO techniques and service offerings. The objectives are to:

- Prepare manufacturers, vendors and suppliers to participate in reinforcing the system optimization message of the UNIDO project with their industrial customers
- Assist manufacturers, vendors and suppliers in identifying what will be required to reshape their market offerings to include or reflect a system services approach

The articulated process, built and managed by UNIDO within its PSO Capacity Building and Implementation Programme, is a joint effort and partnership of international leading specialists, national energy efficiency service providers and forward-looking industrial enterprises coming together to deliver tangible energy, environmental and economic results, while creating business and market opportunities for sustainable pump systems optimization in industry and climate change mitigation. Figure A shows structure and standard schedule of the UNIDO PSO EXPERT training programme.

The present manual is one of the knowledge and training resources used during the UNIDO PSO programme and is made available to participants of the USER and EXPERT training.

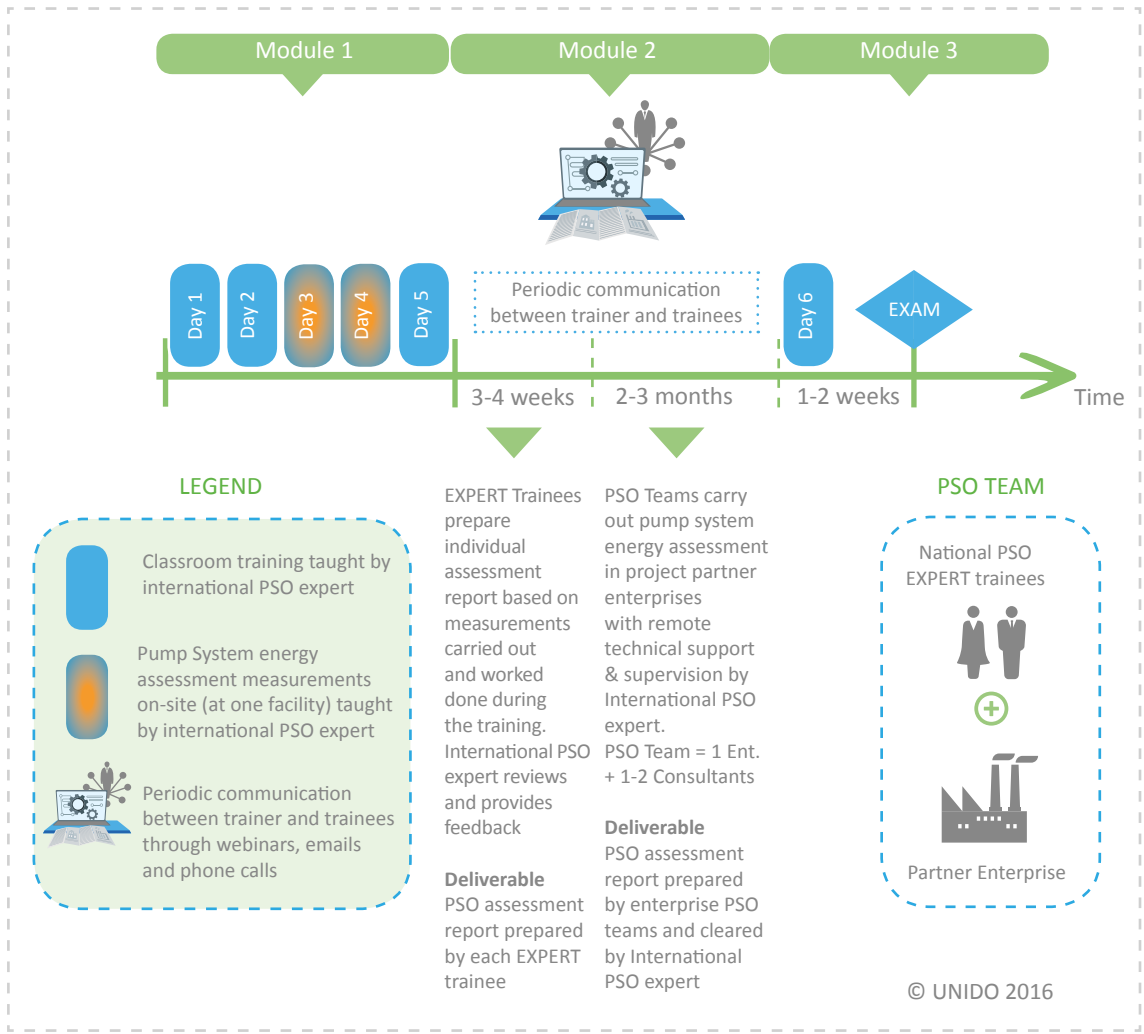


Fig. A. Structure of the UNIDO Pump Systems Optimization EXPERT training programme



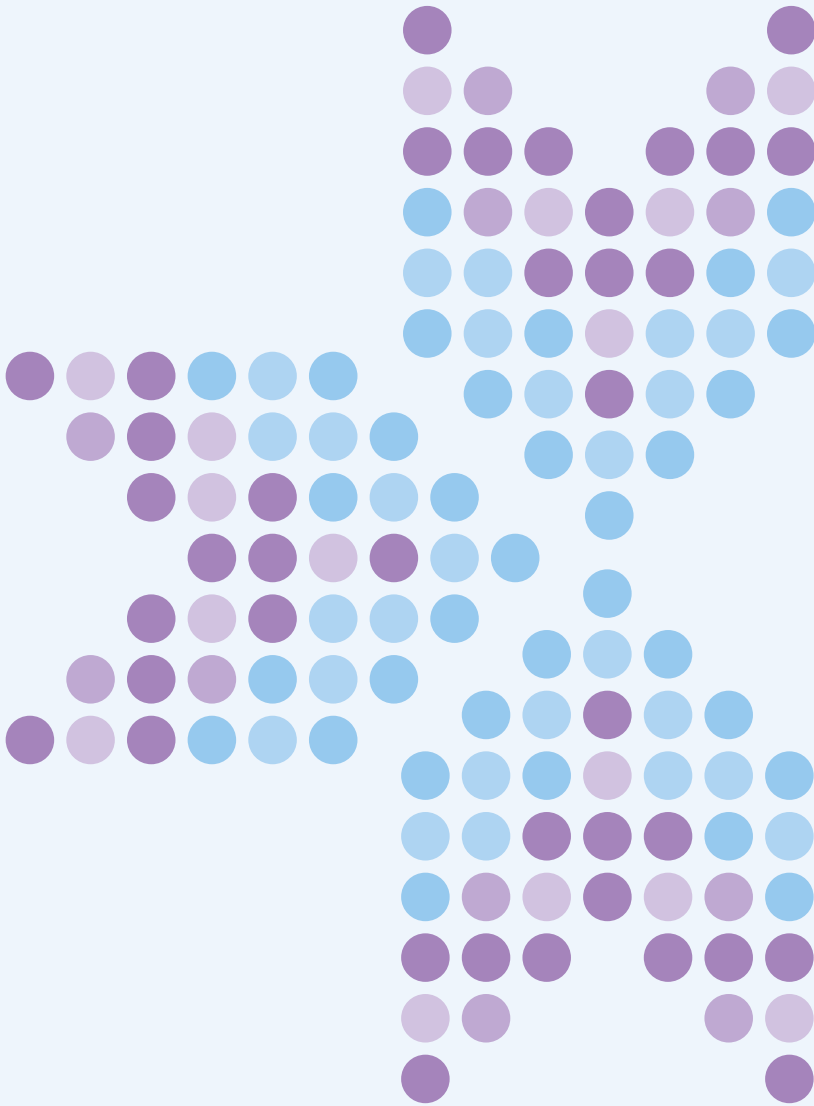
# TABLE OF CONTENTS

---

<b>FOREWORD</b> .....	<b>3</b>
<b>ACKNOWLEDGMENTS</b> .....	<b>4</b>
<b>ABOUT UNIDO</b> .....	<b>5</b>
About UNIDO Industrial Energy Efficiency Programme .....	5
About the UNIDO Pump Systems Optimization (PSO) Programme .....	6
<b>TABLE OF CONTENTS</b> .....	<b>8</b>
<b>1. PUMP SYSTEMS OPTIMIZATION &amp; PRESCREENING</b> .....	<b>11</b>
1.1. General.....	11
1.2. Life Cycle Costs.....	12
1.3. Prescreening.....	13
1.4. Key Learning Points .....	14
<b>2. PUMP SYSTEMS AND PROCESS DEMANDS</b> .....	<b>15</b>
2.1. General .....	15
2.2. System Boundaries .....	16
2.3. Process Demand.....	16
2.4. Duration Diagrams .....	17
2.5. Key Learning Points .....	18
<b>3. PUMP TYPES</b> .....	<b>19</b>
3.1. General.....	19
3.2. Rotodynamic Pumps.....	20
3.3. Positive Displacement Pumps.....	22
3.4. Key Points .....	24
<b>4. BASIC HYDRAULICS</b> .....	<b>25</b>
4.1. General .....	25
4.2. Fundamental Relationships .....	25
4.3. Fluid Flow.....	25
4.4. Head .....	26
4.5. System Curves.....	32
4.6. Key Learning Points .....	33
4.7. Exercises .....	33
<b>5. UNDERSTANDING PUMP PERFORMANCE</b> .....	<b>35</b>
5.1. General .....	35
5.2. Pump Curves .....	35
5.3. Affinity Laws .....	36
5.4. Variable Speed Curves.....	36
5.5. Impeller Trimming.....	37
5.6. Pump Operating Point .....	37
5.7. Pumps Connected in Parallel .....	38
5.8. Pumps Connected in Series .....	38
5.9. Cavitation.....	39
5.10. Key Learning Points.....	40
5.11. Exercises.....	40
<b>6. PUMP MAINTENANCE AND RELIABILITY</b> .....	<b>43</b>
6.1. General .....	43



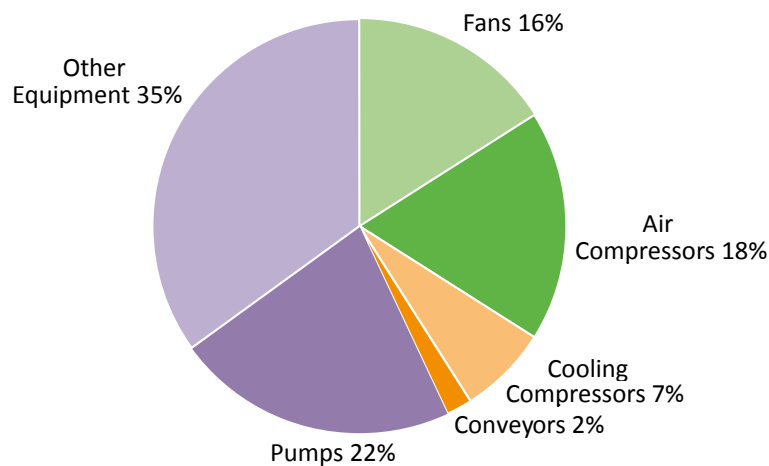
6.2. Factors that influence Reliability .....	44
6.3. Pump System Monitoring .....	50
6.4. Key Learning Points .....	52
6.5. Exercises.....	53
<b>7. PUMP SYSTEM ENERGY USE .....</b>	<b>54</b>
7.1. General.....	54
7.2. Power Equations.....	54
7.3. Using the Power Equations .....	55
7.4. Specific Energy .....	55
7.5. Electric Utility Rate Schedules .....	63
7.6. Key Learning Points.....	65
<b>8. MOTORS.....</b>	<b>66</b>
8.1. General .....	66
8.2. Asynchronous Induction Motors .....	66
8.3. Key Points .....	71
<b>9. CONTROL METHODS FOR PUMPING SYSTEMS .....</b>	<b>72</b>
9.1. Overview .....	72
9.2. Pump Control Strategies.....	73
9.3. System Requirements.....	76
9.4. Understanding Variable Speed Drives.....	78
9.5. Key Learning Points .....	83
<b>10. PSAT PROGRAMME INTRODUCTION .....</b>	<b>84</b>
10.1. Overview of PSAT Programme .....	84
10.2. PSAT Features .....	85
10.3. PSAT Success Stories .....	85
<b>11. ASME PUMP STANDARD INTRODUCTION.....</b>	<b>87</b>
11.1. Overview of the ASME Pump Standard .....	87
<b>12. FIELD ASSESSMENT AND DATA COLLECTION .....</b>	<b>92</b>
12.1. Preparation .....	92
12.2. Data Collection Before Field Assessment.....	92
12.3. Collecting Field Data .....	93
12.4. Fundamentals Review .....	94
12.5. Field Measurements Collection Process.....	97
12.6. Key Learning Points .....	109
<b>13. WORKING WITH THE DATA.....</b>	<b>110</b>
13.1. Overview .....	110
13.2. Developing a System Curve.....	110
<b>14. EXAMPLE PROBLEM.....</b>	<b>113</b>
14.1. System with a Problem Control Valve .....	113
<b>15. APPENDIXES.....</b>	<b>118</b>
15.1. Appendix A: Prescreening Sheet.....	118
15.2. Appendix B: PSAT Manual .....	119



# 1. PUMP SYSTEMS OPTIMIZATION & PRESCREENING

## 1.1. General

From studies carried out by the European Commission it was shown that pumping systems account for about 22% of the worlds electric motor energy demand as shown in Figure 1.1.



**Fig. 1.1.** System components

The large amounts of energy used for pumping makes pump systems a major candidate for energy savings. Of the energy used for pumping, about 75% is used for centrifugal pumps and the remaining 25% for positive displacement pumps.

Over the years pump performance has been improved through optimized design and improved manufacturing techniques, however, the efficiency of a centrifugal pump is very sensitive to where it is being operated on its curve. When a pump has not been matched to system requirements significant savings can be realized through pump systems optimization.

## 1.2. Life Cycle Costs

Pump systems optimization starts with a detailed review of all pump system costs to evaluate the true cost of pumping over the life of the equipment. The initial purchase price of a pump is a small part of the total life cycle costs (LCC) that includes maintenance, installation, down time, and energy costs.

An example of how pumping life cycle costs can be compared to the cost of operating a car is provided in the example below.

### **Example 1:**

#### *Life Cycle Costs of an Automobile*

For a car that is operated 32,000 km/year for 10 years the following costs are assumed:

- Initial year fuel price = 4.90 ZAR/l
- Initial year maintenance & insurance = ZAR 13,920
- Initial year miscellaneous expenses = ZAR 696
- Discount rate = 8%
- Energy inflation rate = 10%
- Other cost inflation rates = 4%

These costs are shown in Figure 1.2.

Based on this data, the total life cycle ownership cost of owning the car in current day ZAR would be 375,840.

Now lets take the same approach with a pump system.

#### *Life Cycle Costs of Pump*

For a 200 kW pump system we will assume the following operating costs:

- Operate the pump for 7,000 hours/year for 10 years
- Initial year electricity price = 35 c/kWh
- Initial year maintenance & insurance = ZAR 139,200
- Initial year miscellaneous expenses = ZAR 13,920
- Discount rate = 8%
- Energy inflation rate = 5%
- Other cost inflation rates = 4%

These costs are illustrated in Figure 1.3.

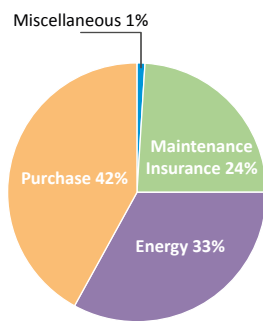
For the pump system, the total life cycle ownership cost in current day dollars is approximately ZAR 5,637,600 (note that the fuel price is conservatively low, and the inflation rate assumed for electricity is only half that assumed for gasoline). If we change the example to reduce the pump operating hours from 7000 hours per year to only 4380 hours, the following assumptions can be made.



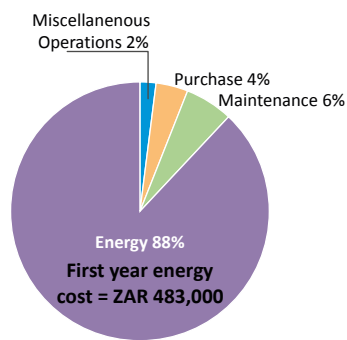
- Operate the pump for 4,380 hours/year for 10 years
- Initial year electricity price = 35c/kWh
- Initial year maintenance & insurance = ZAR 34,800
- Initial year miscellaneous expenses = ZAR 13,920
- Discount rate = 8%
- Energy inflation rate = 5%
- Other cost inflation rates = 4% pump system
- Total life cycle ownership cost in current day ZAR = 3,403,440

These costs are shown in Figure 1.4.

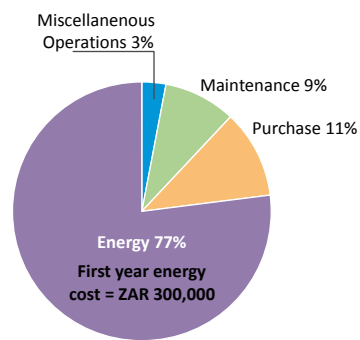
Even with the lower run time hours, pump system energy use is still the highest cost over the life of the pump.



**Fig. 1.2.** Automobile LCC Overview



**Fig. 1.3.** Pump LCC Overview (7000 hours)



**Fig. 1.4.** Pump LCC Overview (4380 hours)

### 1.3. Prescreening

The DOE Best Practices Programme encourages a three tiered prescreening and assessment approach that includes:

- Initial prescreening based on size, run time and pump type
- Secondary prescreening to narrow the focus to systems where significant energy saving opportunities are more likely
- Evaluating the opportunities and quantifying the potential savings

This is illustrated in Figure 1.5 where large centrifugal loads with high operating hours provide the greatest opportunity.

Four common causes of less than optimal pump system performance include:

- Installed components are inefficient at the typical operating condition.
- The efficiency of the pump system components has degraded.
- More flow or more head is being provided than the system requires.
- The pump is being operated when it is not required by the system.

These conditions can be revealed through the following symptoms that provide an indication of pump system improvement opportunities:

- Valves throttled to control flow.
- Bypass (re-circulation line) normally open.
- Multiple parallel pump system with same number of pumps always operating.
- Constant pump operation for a batch process.
- Cavitation noise (at the pump or elsewhere in the system).
- High system maintenance.
- Systems that have undergone a change in function.

A sample prescreening worksheet has been provided in Appendix A.

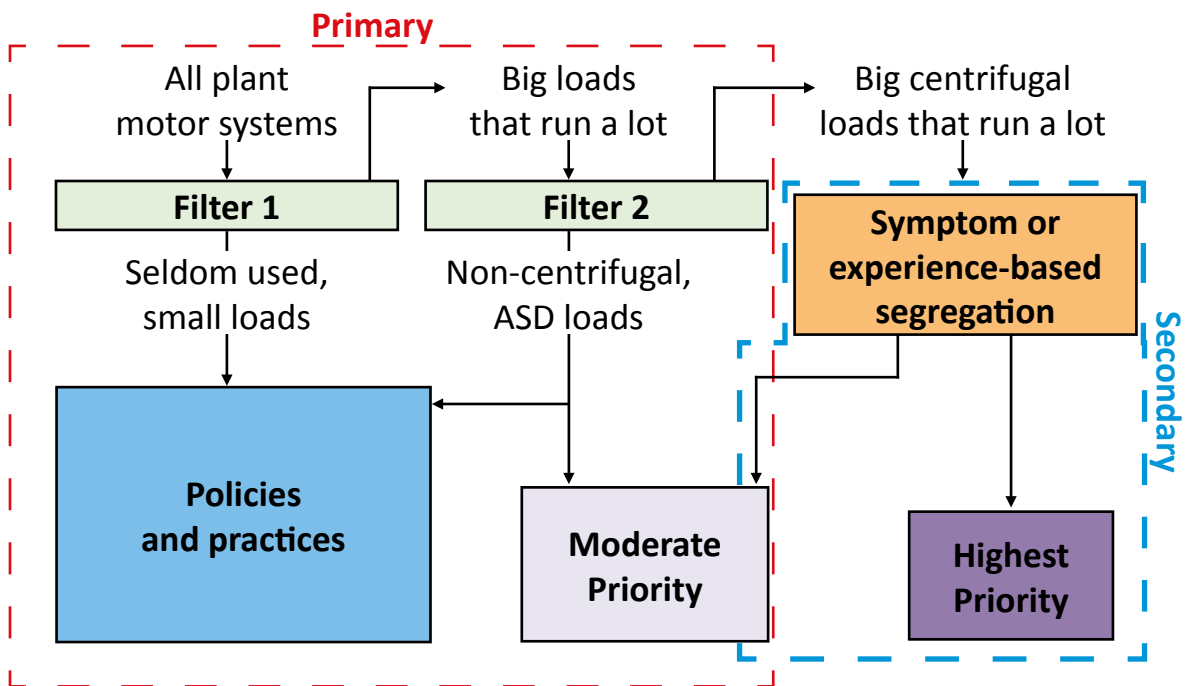


Fig. 1.5. Prescreening Flow Chart

## 1.4. Key Learning Points

Key learning points for this chapter includes:

- Pump systems optimization starts with recognizing the importance of life cycle costs.
- Prescreening is a useful tool to focus on pump systems that provide the greatest opportunity for savings.



## 2. PUMP SYSTEMS AND PROCESS DEMANDS

### 2.1. General

With a pumping system, we must understand all the different components that are connected to and interact with a pump. This includes components like controls and drivers for the pump as well as all the piping and other components (such as valves and heat exchangers) that the fluid passes through.

It is important to understand that all the various components of a pumping system influence each other. Changes to one component will therefore influence other components in a system and thus cannot be treated individually.

In complicated systems, it is necessary to chart out the system and to make sure that all of its parts are included when the system is studied as shown in Figure 2.1.

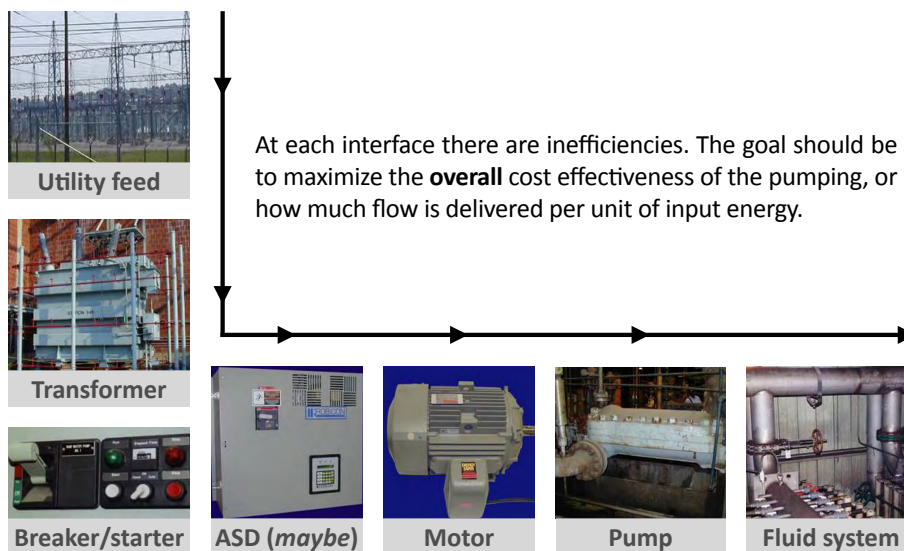


Fig. 2.1. System components



## 2.2. System Boundaries

The importance of correct system boundaries is illustrated in Figure 2.2. This figure shows a simple system pumping from one reservoir to a higher positioned reservoir. The system is equipped with a re-circulating line, a couple of flow meters and pressure sensors. The efficiency of the system varies considerably depending on how the system boundaries are defined. We encourage and recommend that the largest box be defined as the system in this case.

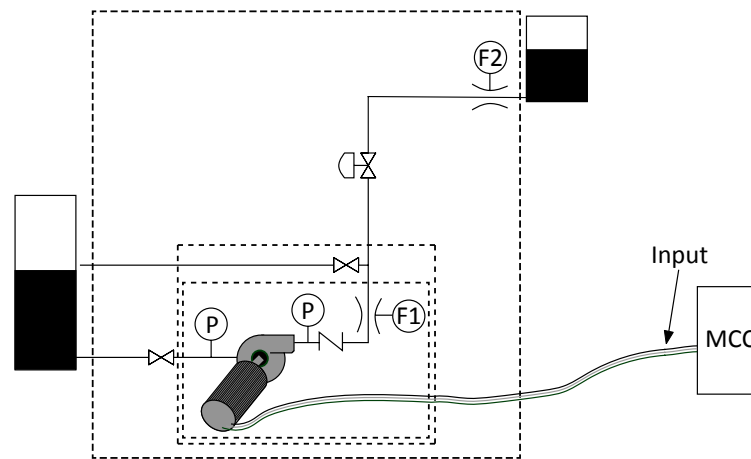


Fig. 2.2. Three possible system boundaries for a simple system

## 2.3. Process Demand

Understanding how flow requirements vary over time is a crucial element in optimizing fluid systems. It is very common for pump systems to be over-designed, that is, that they are capable of delivering more flow or head than what is really needed by the process. The reason for this varies, but common reasons are that the system is designed for “future needs”, an anticipated increase in flow requirement in the future, or that the engineer just wanted to be “on the safe side”. Over-design of the pump systems lead to excessive losses and power consumption, and should therefore be avoided.

### 2.3.1. Constant Flow Requirements

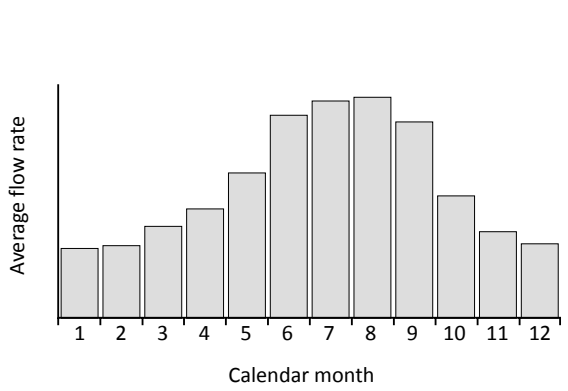
Flow requirements can be constant or variable. For systems with constant flow requirements it is fairly simple to address these issues. The pump system should be designed to deliver what is necessary and not more. If future expansion is called for it is often a better solution to, for example, add a larger impeller when the larger flow is called for.

### 2.3.2. Variable Flow Requirements

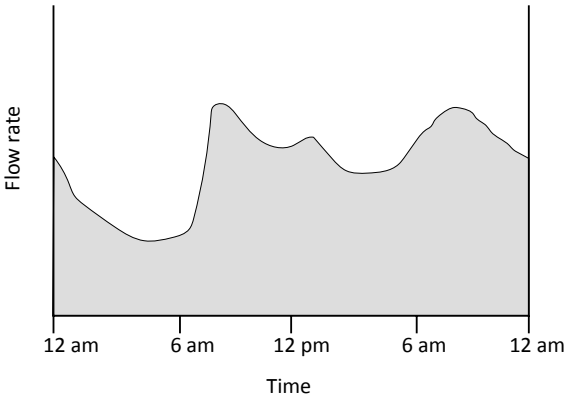
Systems with variable process needs are more complicated to deal with. Examples of systems with varying flow demands are: Seasonal loads (chilled water, associated tower water, etc), industrial processes with variable output, potable water and wastewater systems. This is illustrated in Figure 2.3.



The first task is to get an idea of what the variation is expected to be, or, in an existing system, to measure the variation over a specific period of time. A suitable way of showing the demand is shown in Figures 2.3 and 2.4.



**Fig. 2.3.** Example of annual variation of flow demand



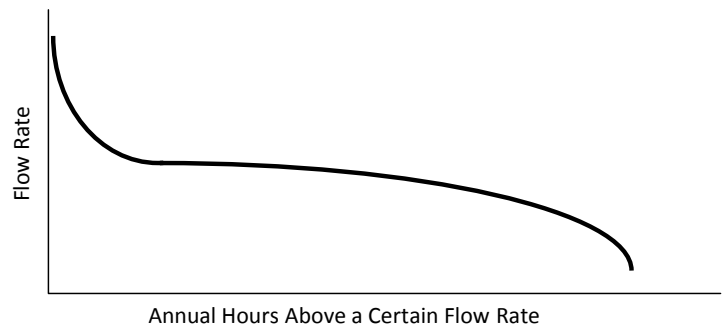
**Fig. 2.4.** Example of daily variations of flow demand

## 2.4. Duration Diagrams

The information in Figures 2.3 and 2.4 can be rearranged to show a “duration curve” which simply highlights the variation of flow requirements over a year. The flow duration diagram in Figure 2.5 shows how many hours during a year the flow requirement exceeds a certain level. The peak flow rate that is required is the intercept with the Y-axis. The advantage of this diagram is that it clearly shows the demands from the system, regarding max flow rate, average flow rate and the variations.

It is fairly common that systems are optimized for maximum flow rates. It is of course important that the system can deliver the maximum required flow rate at a decent efficiency but, from an economic point of view, it is more important that systems are optimized for the flow rates they are going to operate at most of the time.

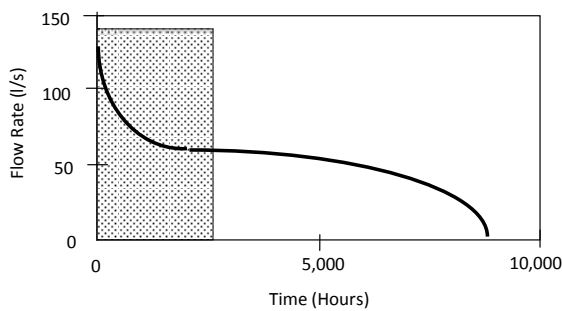
From a Life Cycle Cost perspective, it could for example be cheaper to have one pump set for handling the maximum flow rates and another to handle average flow rates.



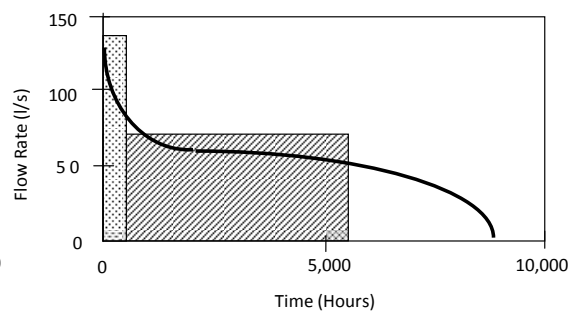
**Fig. 2.5.** Typical annualized duration curve for a wastewater system

As the x-axis highlights time, and the y-axis flow rate, the area below the curve equals the volume that is pumped during one year. Figure 2.6 shows how many hours during a year a large wastewater pump has to run to pump the yearly flow. (equal area under the curves). It is seen that the pump operates less than 2500 hours per year at the peak flow rate.

In Figure 2.7, a smaller pump is added to the system. In this case, the large pump runs about 200 hours per year, whereas the smaller pump runs for a bit more than 5000 hours at a lower flow rate. The advantage with this arrangement is that the flow will be more even and as the flow velocities are smaller the losses will be smaller.



**Fig. 2.6.** Flow duration diagram for a large wastewater pump



**Fig. 2.7.** Flow duration diagram using two pumps, one large and one small

## 2.5. Key Learning Points

Key learning points for this chapter includes:

- Before evaluating pump system operation, the system needs must be defined.
- Process demands may be constant or vary considerably over time. These variations could occur hourly, daily, or monthly.
- A duration curve helps evaluate the number of hours a pump operates at different flow rates and is useful to determine the best combination of pumps to match the system's flow requirement.

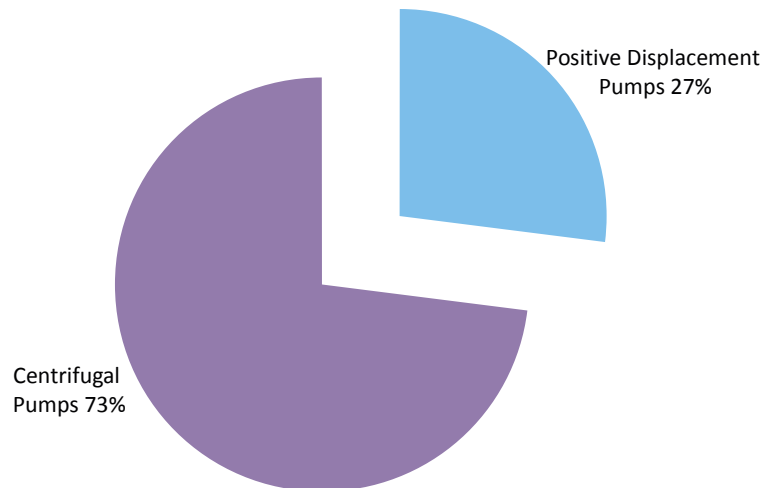


## 3. PUMP TYPES

---

### 3.1. General

Pumps are divided into two main groups- rotodynamic and positive displacement pumps. The names come from how the pumps transfer energy to the pumped media, i.e. by a rotating impeller that transfers energy through a dynamic action or by moving fluid by displacement. As shown in Figure 3.1, the majority of pumps used in industry are rotodynamic or *centrifugal* type pumps.



**Fig. 3.1.** Types of pumps used in industry

Figure 3.2 show different pump types available on the market today. These main groups are then split into subgroups. These subgroups indicate more specifically the mechanical execution of the pumps. Each pump type has its preferred application area, where it fulfills the process demands in the best possible way.

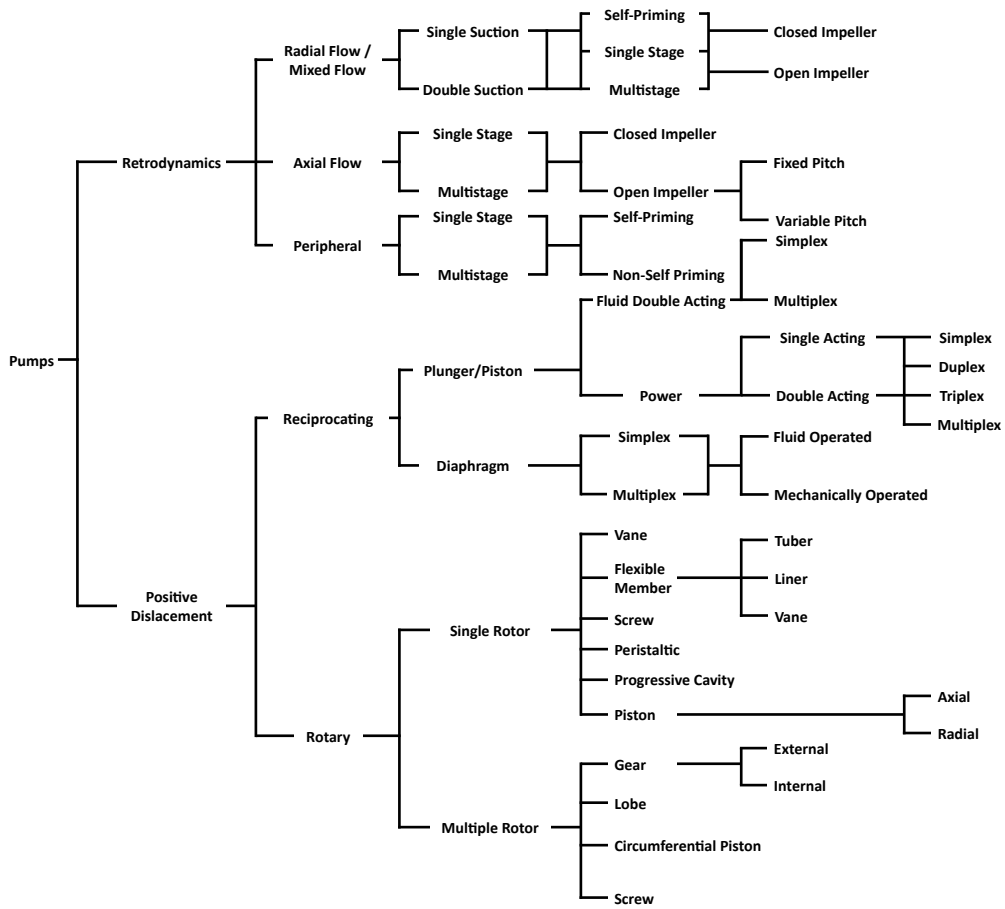


Fig. 3.2. Classification of pumps

### 3.2. Rotodynamic Pumps

A rotodynamic (centrifugal) pump transfers energy to a fluid using a rotating impeller. The fluid enters the pump suction into the eye of the impeller, is accelerated to high velocity, then passes through a diffuser to convert velocity head into pressure head before exiting through the pump discharge as shown in Figure 3.3.

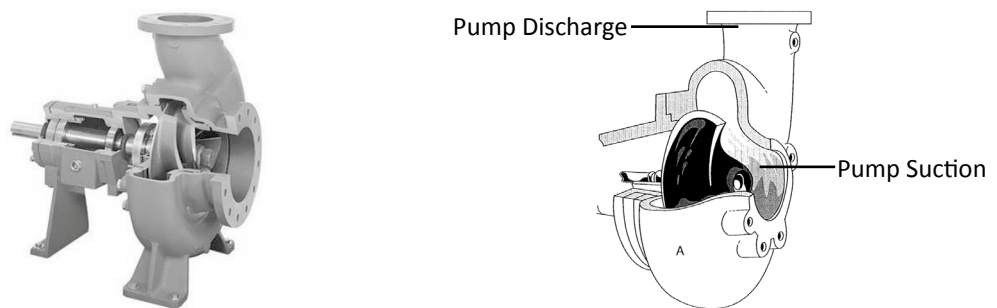
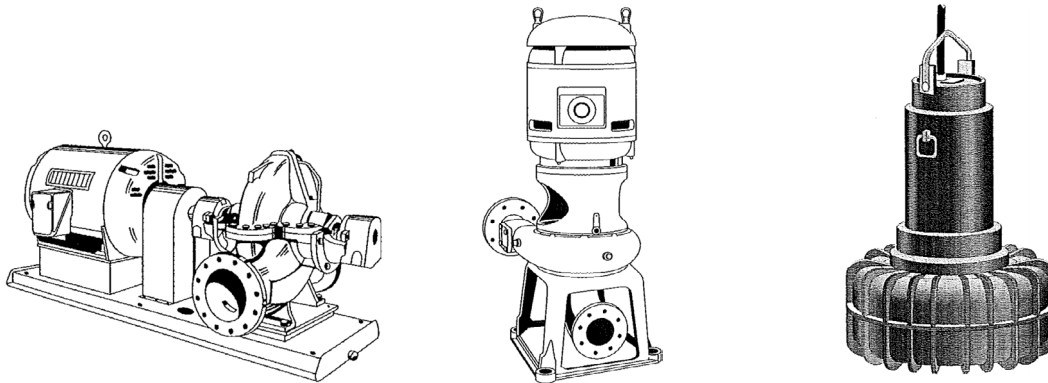


Fig. 3.3. Typical end suction pump



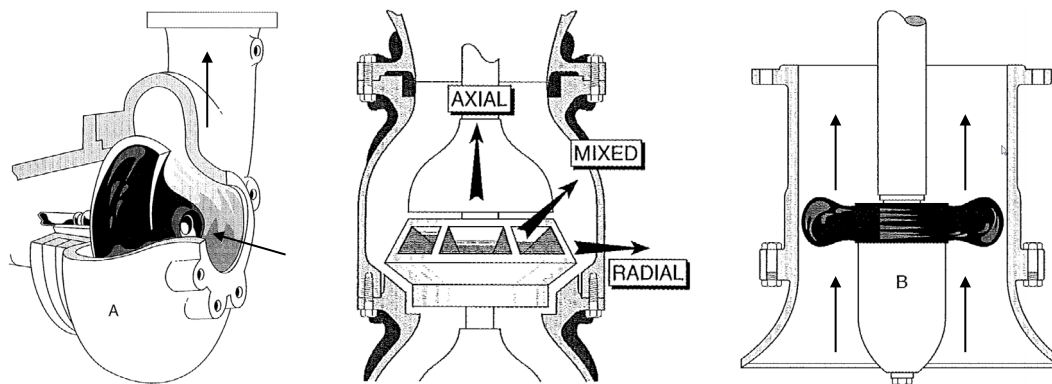
### 3.2.1. Types

Centrifugal pumps can be arranged horizontally or vertically and may be frame mounted or close coupled as shown in Figure 3.4.



**Fig. 3.4.** Frame mounted and close coupled pumps

There are three flow categories for centrifugal pumps: A radial flow pump, where the pump discharge is  $90^\circ$  degrees to the suction; the mixed flow pump, where the discharge is at an angle less than  $180^\circ$  from the suction but greater than  $90^\circ$ ; and the axial flow pump, where water is pushed out the discharge directly opposite the suction. These flow configurations are shown in Figure 3.5.



**Fig. 3.5.** Centrifugal pump flow patterns (radial, mixed and axial)

Radial and mixed flow pumps are the most common pumps on the market. They are often controlled by throttling valves and offer good opportunities for energy savings. Variable speed drives can often easily be used to control output instead of throttling valves. When, and how, to do this will be discussed in detail below. These pumps are available in a large number of executions specialized for high or low flow and high or low head.

For high-pressure pump systems such as municipal water systems or boiler feed pumps, multistage pumps are used to increase pressure by directing flow from an impeller discharge to the next impeller suction as shown in Figure 3.6. As flow moves through each impeller stage, the pressure increases. This concept is discussed more in Chapter 4.

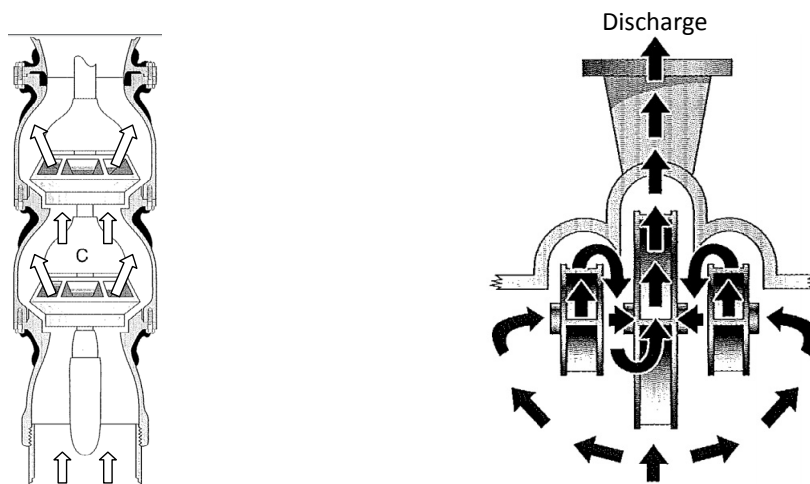


Fig. 3.6. Vertical and horizontal multistage pumps

### 3.2.2. Characteristics

The impeller configuration and number of pump impellers will vary depending on the type of pump. Impellers are classified by specific speed, size and style. Figure 3.7 shows a semi-open, open and closed impeller style.

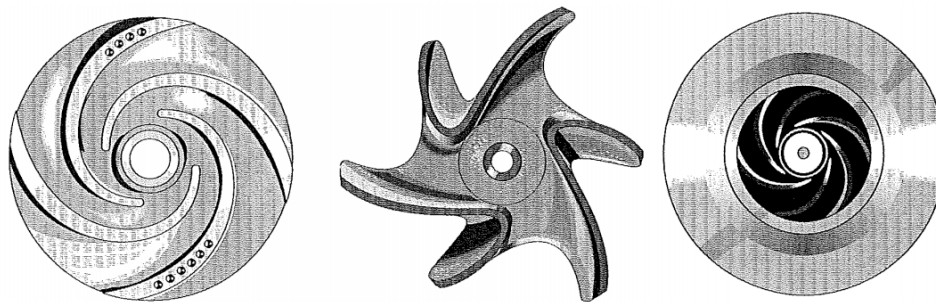


Fig. 3.7. Impeller types (semi-open, open and closed)

The semi-open impeller has one side of the impeller closed in with a shroud and has lower solids capability than an open impeller but is efficient for pumping chemicals, paper, slurry and other industrial process uses. The open impeller design has no shrouds and is mainly used to pump fluids which contain large solids. They are considered to be low-efficiency impellers that will pump high volumes at low pressures. The closed impeller design is very efficient and has both sides of the waterway closed with a shroud. This impeller is typically used for clean liquid service.

## 3.3. Positive Displacement Pumps

The positive displacement pump has an expanding cavity on the suction side and a decreasing cavity on the discharge side. Liquid flows into the pump as the cavity on the suction side expands and the liquid flows out of the discharge as the cavity contracts. A

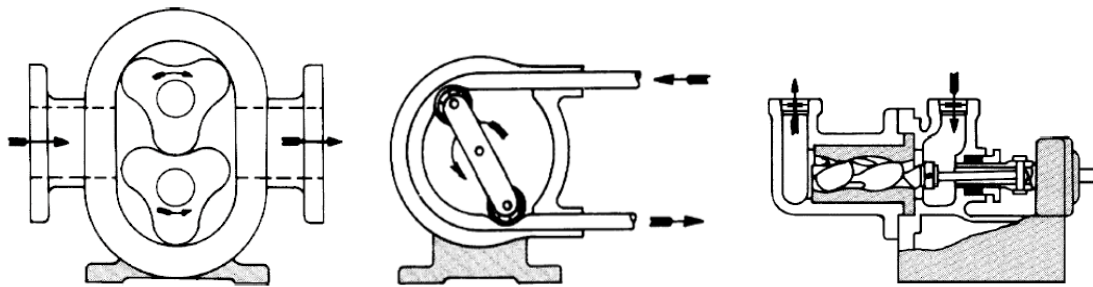


Positive Displacement pump (PD pump), will in theory produce the same flow at a given speed or rpm, regardless of the discharge pressure. In reality the pressure is limited by the torque of the motor and by internal leakage, “slip”. The pressure can nevertheless reach dangerous levels and a pressure relief valve should therefore normally be installed on the pressure side in order to avoid damage to the system. This valve can be external or internal.

Positive Displacement pumps are “constant flow machines”. The flow rate is in general proportional to the speed of the pump, making them ideally suited for flow control by means of variable speed. They are used for high pressures and for viscous fluids.

### 3.3.1. Types

The two main types of PD pumps are reciprocating and rotary pumps. There are many subgroups within these main groups as can be seen in Figure 3.2. An example of several positive displacement pump types is shown below in Figure 3.8.



**Fig. 3.8.** Examples of Rotary Lobe, Tube and Screw Pumps  
(Figures courtesy of Hydraulic Institute)

Rotary PD pumps typically work at pressures up to 3500 kPa. They transfer liquid from the suction to the pressure side through the action of rotating rotors, screws, lobes, gears, rollers etc. that operate within a rigid casing.

Reciprocating PD pumps work at pressures up to 50 000 kPa. They transfer liquid by changing the internal volume, for example, through the action of a piston in a cylinder. They normally have non-return valves fitted to both the inlet and the outlet side of the pump.

### 3.3.2. Characteristics

The “slip” in a rotary PD pump is a function of the viscosity of the pumped media and the output pressure. The slip decreases with increasing viscosity.

The output from a reciprocating PD pump is pulsating in nature with large swings in pressure, as the cavity is filled and emptied. It is critical that these pressure changes be controlled to ensure accurate metering and batching demands and to protect the mechanical integrity of the pump and process equipment. It is therefore common to include pulsation dampening devices and or for the pumps to operate with two or three cylinders. The more cylinders, the more even the flow is.



### 3.4. Key Points

- The two main types of pumps are rotodynamic (or centrifugal) and Positive Displacement pumps.
- Subgroups under the main types are named after their mechanical design features.
- Centrifugal pump arrangement can be frame mounted or close coupled.
- Flow configurations for centrifugal pumps are classified as radial, mixed and axial.
- Centrifugal pumps can have one or more impellers. The three main impeller types are open, semi-open and closed.
- PD pumps are constant flow machines that can generate dangerous pressures and they therefore have to be equipped with pressure relief valves and pulsation dampeners to protect the system.
- PD pumps are mainly used to pump viscous fluids and when very high pressures are required.



## 4. BASIC HYDRAULICS

### 4.1. General

This section on hydraulics provides the fundamental knowledge needed to understand how fluid characteristics affect pump system operation.

### 4.2. Fundamental Relationships

For pump systems, the relationship between fluid power, flow, pressure (head) and specific gravity of the fluid can be expressed in the following equations:

U. S. Units

$$\text{Fluid Power (bhp)} = \frac{\text{Head (ft)} * \text{Flow (gpm)} * \text{specific gravity}}{3960}$$

Metric

$$\text{Fluid Power} = \text{Head (m)} * \text{Flow (m}^3/\text{sec)} * \text{density} * 9.8$$

$$\text{Fluid Power} = \frac{\text{Head (m)} * \text{Flow (m}^3/\text{hr)} * \text{density}}{367}$$

$$\text{Fluid Power} = \frac{\text{Head (m)} * \text{Flow (liters/sec)} * \text{density}}{102}$$

**Eq. 4.1.** Fluid Power Equations (in the U. S. the power delivered by the pump is measured in brake horse power)

### 4.3. Fluid Flow

One of the fundamental laws that govern the flow of fluids is *Bernoulli's law*. In its simplest form it deals with the relationship between pressure and fluid velocity in a frictionless fluid. It

states, “The total energy is constant along a frictionless stream line”. This might sound complicated but it is similar to an ordinary swing for children where the energy changes between potential energy and kinetic energy. (Think of pressure as potential energy and fluid velocity as kinetic). If the two points are located at different elevations this also has to be taken into account. Equation 4.2 shows it in its simplest form.

$P_a + \frac{1}{2} \rho v_a^2 + \rho g h_a = P_b + \frac{1}{2} \rho v_b^2 + \rho g h_b$	<p><i>a</i> = is the first point along the pipe  <i>b</i> = is the second point along the pipe  <i>P</i> = static pressure (ft or m)  <i>ρ</i> = density (ft or m)  <i>v</i> = velocity head (ft or m)  <i>g</i> = gravitational acceleration  <i>h</i> = height (ft or m)</p>
---	--

**Eq. 4.2.** Bernoulli’s equation

Note that the above is valid only for frictionless flow. If friction is present some of the energy is dissipated as heat and that amount of energy has to be added to the right side of the equation, thereby making the pressure, and/or the velocity component, smaller. It is common to divide each term in the equation above by the density and gravitational constant. The different terms can then be measured in feet.

Flow is typically expressed as gallons per minute (gpm) in the U.S and in meters<sup>3</sup>/hr (m<sup>3</sup>/hr) or liters/second (l/s) in all countries using the metric system.

## 4.4. Head

When considering pump systems, head can be characterized as a measure of the total energy transferred to the liquid at a specific operating speed and capacity. Head is typically defined in feet or meters.

When pressure gauges are used to determine head, the following conversions can be used for water (specific gravity of 1.0):

<u>U. S. Units</u>	<u>Metric</u>
<p><i>Head (ft) = 2.31 × Pressure (psi)</i></p>	<p><i>Head (m) = Pressure (kPa)/9.8</i></p> <p><i>Head (m) = 10.2 × Pressure (bar)</i></p>

**Eq. 4.3.** Pressure Conversions

For U.S. units, pressure can be expressed in absolute units (psia) or gauge units (psig). In the metric system, pressures are usually measured in *kPa* or *bars* and are gauge unless noted. For gauge readings, the pressure is given in relation to the atmospheric pressure, in contrast to absolute pressure, which includes atmospheric pressure.

The total head of a system, which a pump must operate against, is made up of the following components:



- Static Head
- Velocity Head
- Friction or Dynamic Head

#### 4.4.1. Static Head

The static head is the difference in elevation between the liquid surfaces in the vessels on the input and output side of the pump. If the pump pumps into a closed system with a pressure different from atmospheric, this pressure has to be taken into account as well. The static pressure is independent of flow rate and is marked as a straight line in a system curve diagram. The energy required to overcome the static pressure is only a function of height and density of the pumped media and can hence not be affected by changes in flow rate.

#### 4.4.2. Velocity Head

Velocity head is the amount of energy in a liquid required to move it at a given velocity and is represented by the following equation:

$h_v = \frac{V^2}{2g}$	$h_v$ = velocity head (ft or m) $V$ = liquid velocity (ft/s or m/s) $g$ = acceleration due to gravity, or $9.81 \text{ m/s}^2$ ( $32.2 \text{ ft/s}^2$ )
------------------------	--

**Eq. 4.4.** Velocity Head

Typically, velocity must first be calculated using Eq. 4.5 before the velocity head can be determined:

$V = \frac{Q}{A}$	$Q$ = flow in cfs ( $\text{gpm} * .00223$ ) or $\text{m}^3/\text{sec}$ $V$ = liquid velocity (ft/s or m/sec) $A$ = pipe area ( $3.14 * r^2$ ) with $r$ in ft or m
-------------------	---

**Eq. 4.5.** Calculating velocities from flow and pipe area

For many high head systems, velocity head is often negligible (less than 0.5 m or 1 ft). However, when velocity head is not negligible, the value must be calculated (possibly for both the suction and discharge side of the pump) and added to pressure gauge readings to determine total head.

#### 4.4.3. Friction Head

Friction head is the head necessary to overcome the friction losses in the piping and pipe components of a pump system. The friction head will vary with the amount of flow, the characteristics of the piping, fittings and valves and the fluid properties. Depending on the pump system, friction losses can also include entrance losses at the end of the suction piping and exit losses at the discharge point.

Friction or dynamic head is a square function of the flow rate. This means that a doubling of the flow rate requires four times the pressure in order to overcome the frictional losses. A lowering of the flow rate therefore has a large influence on the required pressure and hence on the power needed.

The sources of friction are all the different components through which the fluid passes, such as: pipe-walls, valves, elbows, tees, reducers/expanders, expansion joints, tank inlets and outlets. Experimental data of friction losses has been collected over many years and is available from many sources such as the Moody chart, Hydraulic Institute tables, etc.

#### 4.4.3.1. Friction in Pipes

It is common to measure the pressure drop in pipes and other component in feet as a function of flow rate. Friction losses in piping are usually estimated using Darcy-Weisbach equation (Equation 4.6) and the Hazen-Williams equation (Equation 4.7).

The Darcy-Weisbach equation is very useful to examine and to understand what parameters influence *friction* losses in piping:

$\Delta h_f = f \times \frac{L}{d} \times \frac{V^2}{2g}$	$\Delta h_f$ = pressure drop due to friction (ft or m) $f$ = Darcy friction factor $L$ = pipe length (ft or m) $d$ = pipe diameter (ft or m) $V^2/2g$ = velocity head (ft or m)
---	---

Eq. 4.6. Darcy-Weisbach Equation

The friction factor,  $f$ , is affected by the roughness of the piping, the viscosity of the fluid being pumped, the size of the piping, and the velocity of the fluid. The Moody diagram (shown in Figure 4.1) allows the friction factor to be estimated graphically.

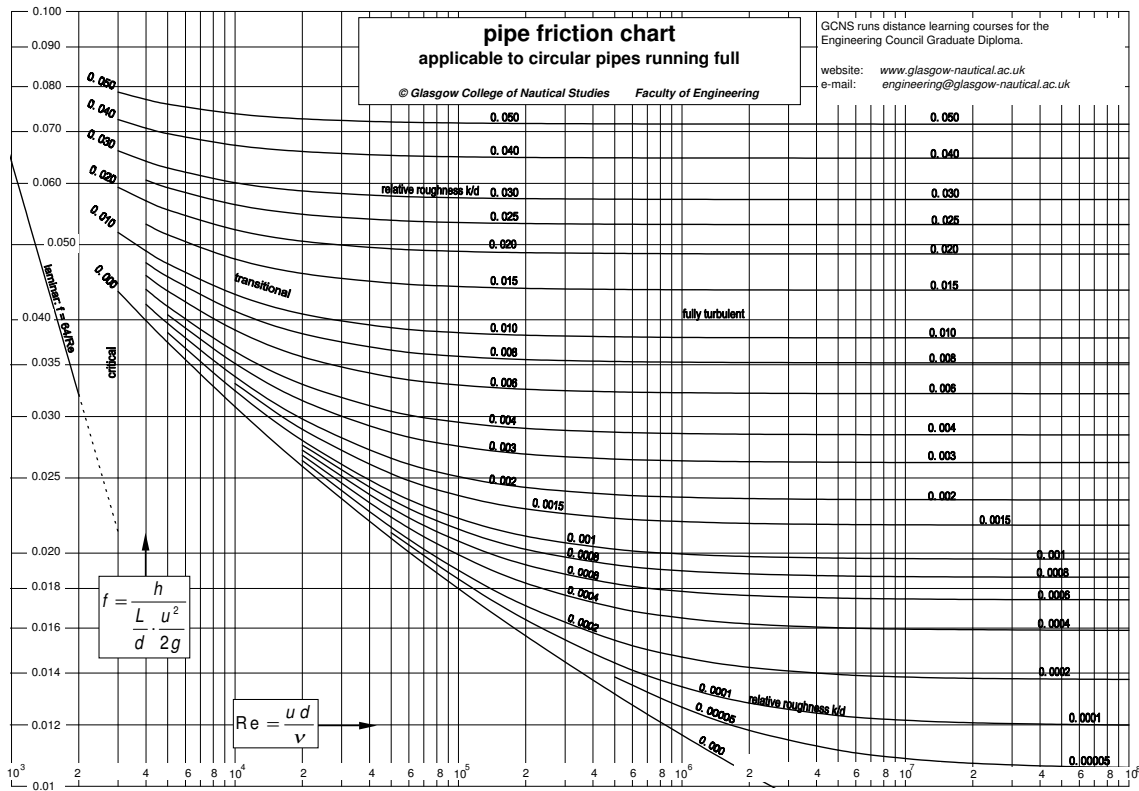


Fig. 4.1. Moody diagram for pipe losses



The *Hazen-Williams method* also calculates piping frictional losses – but must only be used for water systems under turbulent conditions. The Hazen-Williams coefficient (C) is a factor used to account for pipe roughness. New, smooth pipe is normally allocated a (C) value of 140 (although higher values for smooth pipe such as PVC are sometimes used), while older pipes may have (C) values of less than 100.

<i>Metric</i>	
$\Delta h_f = \left[ \frac{10.7 L Q^{1.852}}{C^{1.852} D^{4.87}} \right]$	$\Delta h_f$ = Headloss (m) L = Length (m) Q = Flow (m <sup>3</sup> /s) D = Pipe diameter (m) C = Hazen-Williams coefficient (60-160 range)
<i>U. S. Units</i>	
$\Delta h_f = \left[ \frac{4.7 L Q^{1.852}}{C^{1.852} D^{4.87}} \right]$	$\Delta h_f$ = Headloss (ft) L = Length (ft) Q = Flow (ft <sup>3</sup> /s) D = Pipe diameter (ft) C = Hazen-Williams coefficient (60-160 range)

**Eq. 4.7.** Hazen-Williams Equation

Over time, some pipe systems accumulate significant scale, corrosion, foreign material, or other buildups on the pipe walls. As can be seen from the Darcy-Weisbach relation, any reduction in pipe diameter (not to mention increased roughness and its effect on the friction factor) can have a significant impact on frictional losses.

Figure 4.2, shows a section of pipe removed from a water distribution system. The piping shows considerable tuberculation buildup that would certainly have major impact on the system friction losses.



**Fig. 4.2.** Water distribution pipe with significant tuberculation (courtesy of Diagnostic Solutions)

When systems experience severe fouling or build-up like in Figure 4.2, the capacity of the system to deliver flow diminishes severely. There are two methods that could be used to maintain desired flow rate. Either install a bigger pump or do something about the pipe system. Installing a bigger pump is costly both to install and operate. The other alternative is to clean the pipe, if possible. The pipe in Figure 4.2 was cleaned using what is commonly referred to as a “pipe pig” – a device that is inserted into the system and forced through by fluid pressure.



**4.4.3.2. Friction losses in valves and valve characteristics**

In industry, control valves have been a principal means of controlling flow in pumping systems. Valves can be used to completely isolate flow or adjusted to modulate the flow rate. Valves used to modulate the flow rate are generally referred to as *control valves*, while valves that are either fully opened or closed to isolate flow are called *isolation valves*.

System frictional loss analyses are usually based on loss characteristics. However, valve suppliers typically rely on the relationship shown in Equation 4.8 to define the flow characteristics of the valve.

<i>Metric</i>	
$Q_v = K_v \sqrt{\frac{\Delta P}{s.g.}}$	Q = flow rate ( <i>m<sup>3</sup>/hour</i> ) K <sub>v</sub> = flow coefficient ΔP = differential pressure ( <i>pascals</i> ) s.g. = specific gravity
<i>U. S. Units</i>	
$Q_v = C_v \sqrt{\frac{\Delta P}{s.g.}}$	Q = flow rate ( <i>gpm</i> ) K <sub>v</sub> = flow coefficient ΔP = differential pressure ( <i>psi</i> ) s.g. = specific gravity

**Eq. 4.8.** Valve Characteristic Equation

**4.4.3.3. Friction in Piping Components**

Piping component friction losses such as valves, elbows, and tees are primarily dependent on experimental data and are often referred to as minor losses. However, in many piping systems, these minor losses can contribute a significant amount of frictional losses - especially when control valves are used to reduce system flow. For pipe components, friction losses are often estimated based on the velocity head as shown in Equation 4.9

$\Delta h_f = K \times \frac{V^2}{2g}$	Δh <sub>f</sub> = friction head loss ( <i>ft or m</i> ) K = loss coefficient V = fluid velocity ( <i>ft/sec or m/s</i> ) g = gravitation constant ( <i>ft/sec<sup>2</sup> or m/s<sup>2</sup></i> )
--	---

**Eq. 4.9.** Darcy-Weisbach Equation for Pipe Component Friction Losses

(K) is a loss coefficient that is a function of size, and for valves, the valve type, and valve % open. There are various sources that provide piping component loss coefficients for standard components. Some typical (K) values are provided in Table 4.1.

A good rule of thumb is to assume that the generic data is within 10-15% of the actual for new installations. As equipment ages, the variability between generic and actual is likely to grow. Measurement of line pressures and flow rates *with good instrumentation* will provide a much more representative picture of what actual losses are (and what the actual pump performance is).



**Table 4.1.** Pipe System Component *K* Values

Component Type	<i>K</i>
90° elbow, standard	0.2 - 0.3
90° elbow, long radius	0.1 - 0.2
Square-edged inlet (from tank)	0.5
Bell mouth inlet	0.05
Discharge into tank	1
Tee (branch flow)	0.3 - 1
Swing check valve	2
Gate valve (full open)	0.03-0.2
Globe valve (full open)	3-10
Butterfly valve (full open)	0.5-2
Ball valve (full open)	0.04-0.1

#### 4.4.3.4. Component Losses Using Equivalent Pipe Length Method

Many systems are made up of a series of pipes and components. To assess the overall losses in a series of devices, the individual losses are summed. A common technique used to estimate the overall friction loss in a series of pipe and components is to represent the component losses as equivalent lengths of pipe.

One approach is to convert the individual component loss coefficients into an equivalent number of pipe diameters, and then add the equivalent pipe lengths to the length of the actual system pipe. Some sources of component loss data include equivalent *L/D* ratios for many pipe fittings. Users can calculate equivalent lengths from loss coefficient data, as shown in Equation 4.10.

$\frac{L}{D} (\text{equivalent}) = \frac{K}{f}$	<i>L/D</i> = length/diameter ratio <i>K</i> = component loss coefficient <i>f</i> = friction factor
---	---

**Eq. 4.10.** Estimating Components Losses as Equivalent Lengths of Pipe

One problem associated with this calculational approach is the fact that, as noted above, the friction factor varies with flow rate. A reasonable approach to solving this dilemma is to use the friction factor for the highest anticipated flow rate, as head requirements are almost always driven by the highest flow rate condition (at which the frictional losses are greatest). Although the friction factor will be higher at lower flow rates, that increase will be more than compensated by the reduced velocity head.

#### 4.4.4. Other Effects on Head

##### 4.4.4.1. Specific gravity or density

The specific gravity of a substance is a comparison of its density to that of water at 4 degrees C. Substances that have a lower density than water will have a specific gravity of less than one. Substances with densities higher than water will have a specific gravity greater than one.



The lower the specific gravity of a fluid the less power is required to pump it. Conversely, a fluid with higher specific gravity will require a greater amount of power. Temperature also affects specific gravity as shown in Table 4.2.

**Table 4.2.** Effects of Water Temperature and Specific Gravity/density and Power

Water Temp °C	Specific Gravity/Density	kW
4	1.0	100
60	0.983	98.3
100	0.958	95.8
125	0.939	93.9
150	0.917	91.7

#### 4.4.4.2. Viscosity

Viscosity can be considered the fluids internal friction and varies with the type of fluid being pumped. Viscosity is expressed in three different ways as shown below:

- Saybolt seconds universal or SSU
- Centistokes – defining the kinematic viscosity
- Centipoises – defining the absolute viscosity

The Hydraulic Institute has published charts that provide the viscosity of various liquids at certain temperatures in SSU and centistokes.

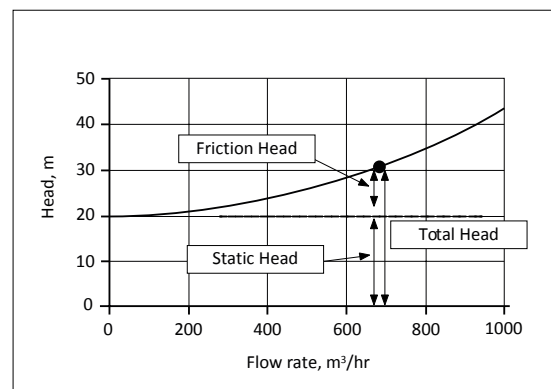
Viscosity effects pump performance in relation to the pump fluid and disk friction. When the viscosity of a fluid increases, the discharge pressure, capacity and efficiency will be reduced, and greater power will be required. The viscosity of a fluid is also directly related to the temperature of a fluid -the lower the temperature, the higher the viscosity.

## 4.5. System Curves

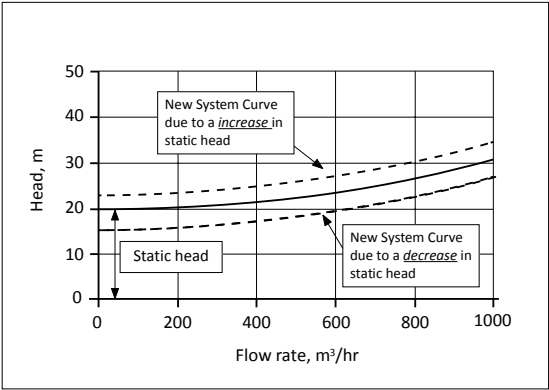
Up to this point, we have reviewed how head, flow and specific gravity affect fluid power. These flow characteristics can be expressed graphically using a system curve in Figure 4.3.

A system curve consist of two fundamental parts, the static and the friction head, as shown in Figure 4.3. As discussed, static head is related to the difference in tank elevations, hence, when suction or discharge tank elevations (or pressures) change, the system curve will also change as shown in Figure 4.4.

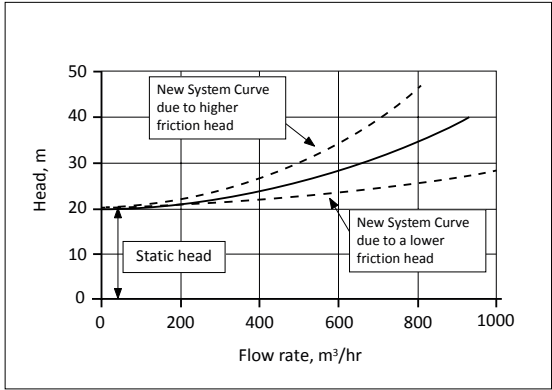
For changes in frictional head the system curve will be altered as shown in Figure 4.5. It can be seen that the point where the curve begins, at zero flow (representing the system static head), does not change when the frictional head changes.



**Fig. 4.3.** System Curve Components



**Fig. 4.4.** Impact of static head changes on system curve



**Fig. 4.5.** Impact of frictional head changes on system curve

## 4.6. Key Learning Points

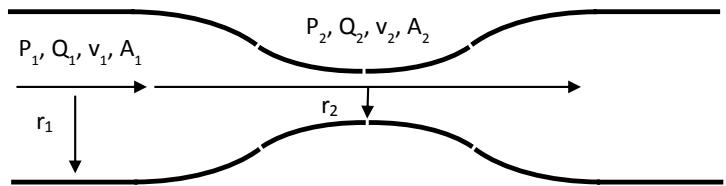
Key learning points for this chapter includes:

- Fluid power required for pumping is related to the flow, head, and specific gravity of a fluid.
- Total head consists of static head and frictional head
- Friction losses in Pipes and common Pipe System Components
- A system curve provides a graphical relationship between flow and head. Depending on the type of head, the system curve will be impacted in different ways

## 4.7. Exercises

### Example #1

$P$  = pressure (kPa or psi)  
 $Q$  = flow (l/s or gpm)  
 $v$  = velocity (m/s or ft/s)  
 $r$  = pipe radius (m or ft)  
 $A$  = pipe area (m<sup>2</sup> or ft<sup>2</sup>)



The following is known for points A and B:

Flow = 10.0 l/s (9510 gpm)  
 Density ( $\rho$ ) = 1000 kg/m<sup>3</sup> (62.4 lb/ft<sup>3</sup>)  
 $r_1$  = 0.1 m (0.328 ft)  
 $P_1$  = 200 kPa (29 psi)  
 $r_2$  = 0.02 m (0.066 ft)

Use the relationship between pressures, flow and pipe area, to determine the velocity in both areas of the pipe and determine  $P_2$ .



**Answer:**

$$A_1 = 3.14 \times (0.1)^2 = 0.0314 \text{ m}^2 (0.338 \text{ ft}^2)$$

$$A_2 = 3.14 \times (0.02)^2 = 0.001256 \text{ m}^2$$

$$v = P/A$$

$$v_1 = 0.01 / 0.0314 = 0.318 \text{ m/s}$$

$$v_2 = 0.01 / 0.001256 = 7.96 \text{ m/s}$$

$$P_2 = P_1 - \rho/2 \left( (v_2)^2 - (v_1)^2 \right)$$

$$P_2 = 200,000 - 1000/2 \times \left( (7.96)^2 - (0.318)^2 \right) = 168,370 \text{ N/m}^2 = 168 \text{ kPa}$$



## 5. UNDERSTANDING PUMP PERFORMANCE

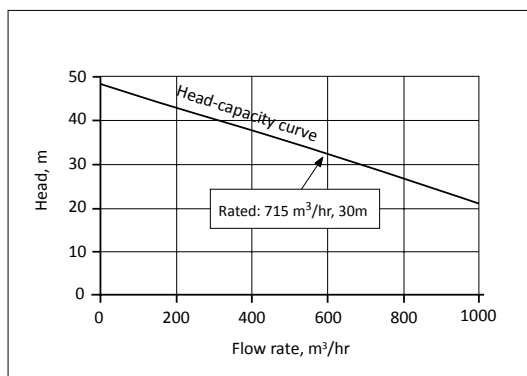
### 5.1. General

The design of centrifugal pumps is characterized by one or more vanned impeller(s) rotating inside a pump housing. The impeller(s) transfer energy to the fluid when rotating and this energy is used to move the liquid, increase its pressure, or both. The rotodynamic pumps are split into two major groups, *radial and axial pumps*. There are also a number of pumps that fall in between these groups and they are commonly known as *mixed flow pumps*.

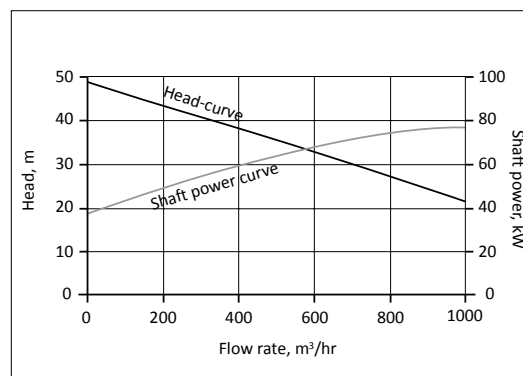
The second large group of pumps, positive displacement pumps, or PD pumps, transfer energy to the fluid by containing the fluid within walls that are moved and discharge the fluid through openings or valves at the pump outlet. PD pumps do not have the same characteristic behavior as centrifugal pumps.

### 5.2. Pump Curves

The performance of a centrifugal pump is usually shown in a diagram (see Figure 5.1) that plots head (H) versus flow (Q). Parameters such as efficiency (shown in Figure 5.2), shaft power and net positive suction head (NPSH) are frequently displayed in the same diagram.



**Fig. 5.1.** Centrifugal pump head capacity curve



**Fig. 5.2.** Power curve added to a basic pump curve

### 5.3. Affinity Laws

Changes to pump performance are governed by the so-called *affinity laws* as shown in Equations 5.1 and 5.2. The affinity laws describe how pump performance is changed when the speed or impeller diameter is changed. It should be noticed that the affinity laws are used to calculate how the *pump performance curves* are changed, when the pump geometry or speed is changed. They do not give any information about what the new operating point will be when the pump is hooked up to a system. In order to find a new operating point, it is necessary to also have information about the system curve that the pump is operating on.

To accurately calculate energy savings, both for speed reductions and for impeller trimming, the system curve has to be known. Failure in this area can lead to major errors.

$Q_2 = Q_1 \times \left( \frac{N_2}{N_1} \right)$	$H_2 = H_1 \times \left( \frac{N_2}{N_1} \right)^2$	$P_2 = P_1 \times \left( \frac{N_2}{N_1} \right)^3$
---	---	---

**Eq. 5.1.** Affinity Laws

(*Q*) = flow rate, (*N*) = rotational speed, (*H*) = head, and (*P*) = power. The subscripts 1 and 2 represent two different speeds.

Another form of the affinity laws relates to impeller diameter, (*D*):

$Q_2 = Q_1 \times \left( \frac{D_2}{D_1} \right)$	$H_2 = H_1 \times \left( \frac{D_2}{D_1} \right)^2$	$P_2 = P_1 \times \left( \frac{D_2}{D_1} \right)^3$
---	---	---

**Eq. 5.2.** Alternative form of Affinity Laws

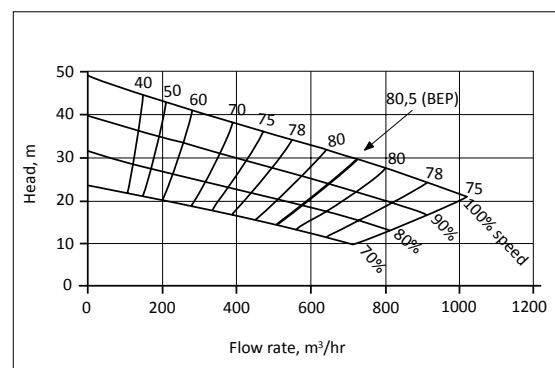
The subscripts 1 and 2 represent two different impeller diameters. The impeller diameter affinity scaling relationships have proven useful in some field-based measurement experiences in that the impeller diameter used as the basis for the performance curves can be modified iteratively to a point where the curve-based flow estimates from measured head and power are in agreement.

### 5.4. Variable Speed Curves

Figure 5.3 shows how the pump performance curves change when the speed of the impeller is changed in a given pump. The new *reduced speed pump curves* can be accurately calculated using the affinity laws, described above.

Iso-efficiency lines are also shown. In the case of speed regulation, these are second-degree functions originating from the origin. The power consumed by the pump is proportional to the cube of the speed along these iso-efficiency

**Fig. 5.3.** Pump curves for varying speeds





lines. Substantial power reductions can therefore be achieved in many systems by changing the speed of the pump driver, thereby reducing the flow rate. The achievable energy savings cannot be calculated without also knowing the system curve, which together with the pump curve determines where on the pump curve (and at what efficiency) the pump is going to operate.

## 5.5. Impeller Trimming

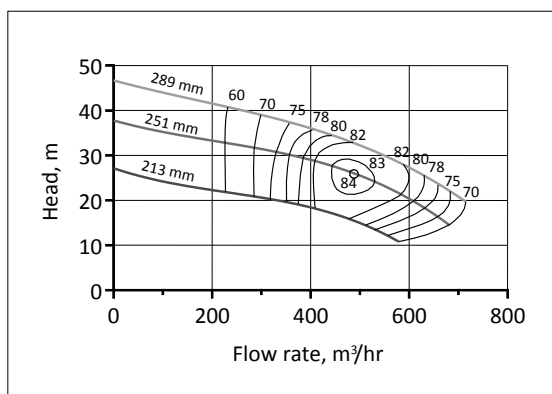
Figure 5.4 shows the corresponding curves for impeller diameter changes in a pump. As seen, the iso-efficiency curves are radically different from the variable speed curves in Figure 5.5. These curves now look like a topographical map, with the peak at a certain diameter and operating point. This is also the point where the optimum relationship between impeller diameter, pump housing geometry and flow rate is found. Deviations from this point, in any direction, cause losses in the pump to increase and the efficiency to decrease. The reduced diameter pump curves can also be calculated using the affinity laws as long as the changes are minor. For larger changes, it is recommended to contact the manufacturer who should have the required information.

## 5.6. Pump Operating Point

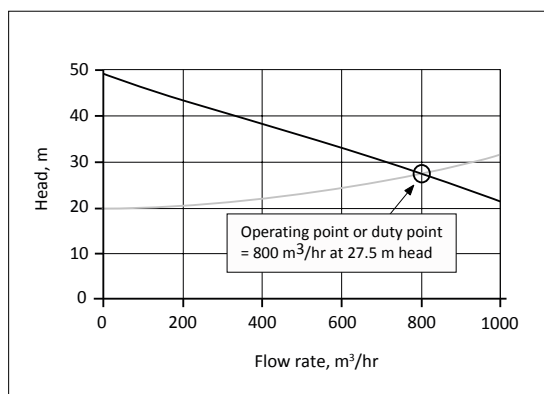
The pump will operate at a point on its curve where there is equilibrium between the pressure supplied by the pump and the pressure needed to pass a certain flow rate through the system attached to the pump. This is illustrated graphically in Figure 5.5. The operating point is where the system and pump curves intersect.

The system curve can be changed, for example, by throttling the pump discharge valve, which increases the resistance in the system and makes the system curve steeper.

It follows that when the operating point moves up to the left on the pump curve the internal forces on the pump impeller then increase, which can lead to shorter equipment life. Care should be taken so that operation high up on the pump curve for long periods of time is avoided. For this reason the manufacturer usually gives out information about the allowable operating region. If the pump is operated outside the boundaries of this region for long periods of time equipment life can be seriously impacted.



**Fig. 5.4.** Pump curves and iso efficiency lines for various impeller diameters



**Fig. 5.5.** System and pump curves with operating point

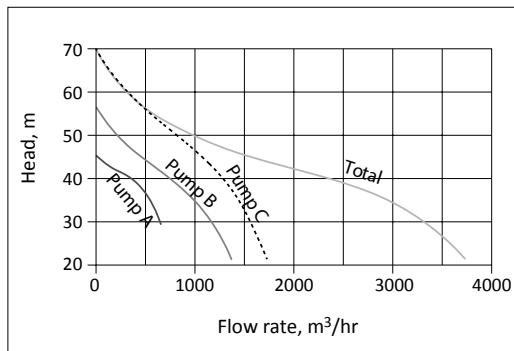
## 5.7. Pumps Connected in Parallel

It is common in many applications to connect pumps in parallel. This provides both flexibility and redundancy. By operating pumps in parallel, the flow can be changed in steps depending on how many and what sized pumps are turned on.

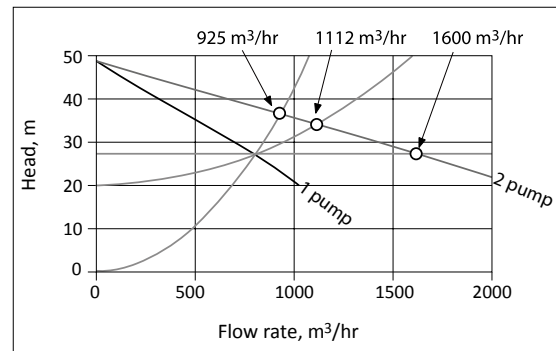
When pumps are connected in parallel, the flow for each operating pump is added at constant pressure, as illustrated in Figure 5.6. If the shut off head (the maximum achievable pressure a pump can generate) differs between the pumps, care has to be taken so that the pumps are not operating at higher pressure than the highest recommended pressure for the pump with the lowest shut off head.

If this is not done, the result may be that the smaller pump is operating in a harmful area or even subjected to reverse flow through the pump. A control system that controls which pumps are on or off can eliminate this risk.

The resulting flow when pumps are connected in parallel depends on the system curve. The system curve generally doesn't change when more pumps are run, but when the flow increases the required pressure also increases and all pumps will operate at this higher pressure on their respective curves. Only in systems with very flat system curves will the resulting flow rate come close to the sum of the flow rates of the individual pumps operated individually. This is shown in Figure 5.7.



**Fig. 5.6.** Combined pump curve for pumps connected in parallel

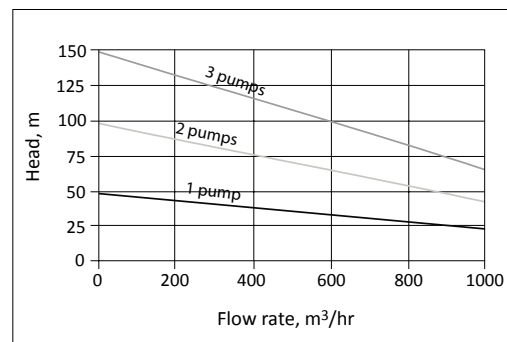


**Fig. 5.7.** Resulting flow rates for two equal pumps operating in parallel for three different systems

## 5.8. Pumps Connected in Series

Just as pumps can be connected in parallel, they can also be connected in series. This is usually done when high heads are required. The combined pump curve is obtained by adding the pressure generated for the various flows.

**Fig. 5.8.** Resulting pump curves for two and three identical pumps connected in series





## 5.9. Cavitation

The boiling temperature of a fluid depends on the pressure in the fluid. The boiling temperature of water at atmospheric pressure is 100 degrees centigrade. However, it is well known that water boils at less than 100 degrees at high altitudes. In Johannesburg, for example, the boiling temperature of water is 96 degrees centigrade. If the pressure is low enough, the liquid will boil at room temperature.

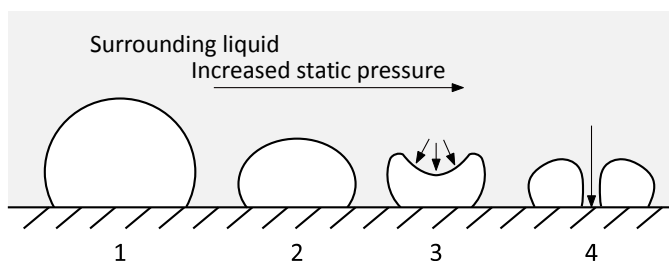
Bernoulli's law governs the pressure in a fluid system. If the fluid velocity gets high, the pressure gets low. The pressure is also a function of how much friction there is in the system. Due to these two facts, it is common that the pressure at the inlet of an impeller can get low enough for the liquid to boil or form vapor cavities at room temperature.

A low pressure at the inlet can come both from pressure losses between the source of the liquid and because of the fluid being accelerated to high speeds when it enters the impeller. Small vapor bubbles are formed and swept with the flow. As the purpose of the pump is to increase pressure, the bubbles rapidly move into an area of higher pressure where they implode. If the implosion takes place in the midst of the fluid it will implode uniformly and is not a major concern, but if the cavity is moving along a surface when it implodes then there will be no fluid filling the cavity from the direction of the wall and the liquid filling the cavity will form a micro jet directed towards the surface.

Such micro jets are strong enough to remove material from the surface of the wall. After constant bombardment over time, a surface exposed to cavitation will deteriorate and attain a very rugged look. See Figure 5.10.

The only way to avoid cavitation is to increase the pressure to such a level that formation of vapor bubbles cannot take place. In order to know how high the pressure needs to be to avoid cavitation, it is necessary to compare the pressure in the liquid to the vapor pressure of the fluid at the temperature at hand. To do this we use the term NPSH or Net Positive Suction Head, which is a measure of the actual pressure in a liquid and the liquids vapor pressure at a given temperature.

Cavitation bubble imploding close to a fixed surface generating a jet (4) of the surrounding liquid.



**Fig. 5.9.** Formation of damaging micro jets in connection with cavitation



**Fig. 5.10.** Cavitation damage on an impeller



To show the pressure that is available over the vapor pressure we form NPSHA.

$$NPSHA = H_s + H_a - H_{vp} - H_f$$

where:

$H_s$  = the static head above the centerline of the impeller,

$H_a$  = the pressure on the free surface of the liquid in the suction tank,

$H_{vp}$  = the vapor pressure of the liquid, and

$H_f$  = all the friction losses on the pump inlet side

The available NPSHA has to be compared to the required NPSHR, which is published by the pump manufacturer after testing when the pump starts to cavitate. It should be noted that the NPSHR is measured at a point where the discharge pressure has dropped 3% relative to the non-cavitating performance. Hence, at this point the pump is already cavitating.

There have been several attempts to define a safe margin above NPSHA to avoid cavitation. So far, manufacturers have not been able to agree on such a margin.

In each case when there is a risk of cavitation, the designer should contact the manufacturer and try to get guidance on how large the margin should be in the specific case.

## 5.10. Key Learning Points

Key learning points for this chapter includes:

- Understanding centrifugal pump curves
- Knowing what information is provided in the various curves
- Understanding the affinity laws and what they can be used for
- Knowing where the pump will operate on its curve
- Knowing how pump performance is changed when speed or geometry is changed
- Understand what happens when pumps are connected in parallel or series
- Understanding what cavitation is

## 5.11. Exercises

### Example #1

A double-suction centrifugal pump equipped with a 355 mm diameter impeller is throttled to provide a process cooling water flow rate of 190 l/s. The pumping system operates for 8,000 hours per year with a head of 50 m and pump efficiency ( $\eta$ ) of 80%. The pump requires 119 kW. An examination of the pump and systems curves indicates that the required flow rate of 190 l/s can be supplied at a head of 38 m using a trimmed impeller. There is no static head in the system.

Calculate an approximate new trim for the impeller that will deliver the necessary flow. Then calculate the approximate energy and cost savings using a cost of 0.10 USD/Euro per kWh. Assume a 94% motor efficiency.



**Answer:**

Using the affinity laws, the diameter of the trimmed impeller can be approximated as follows:

$D_2 = D_1 \times \left( \frac{H_2}{H_1} \right)^{1/3}$	$D_2 = 355 \times \left( \frac{41}{54} \right)^{1/3}$	$D_2 = 325$
---	---	-------------

With a 325 mm trimmed impeller installed, input power requirements can be determined using the pump equation.

$$\text{Power (W)} = \frac{\text{Flow} * \text{Head} * \text{Density}}{102 * \eta_{\text{pump}} * \eta_{\text{motor}}}$$

$$\text{Power (W)} = \frac{190 * 38 * 1000}{102 * 0.8 * 0.94}$$

Power = 94.1 kW

Energy savings are:

$$(119.0 \text{ kW} - 94.1 \text{ kW}) \times 8000 \text{ hrs/year} = 200 \text{ 000 kWh/year.}$$

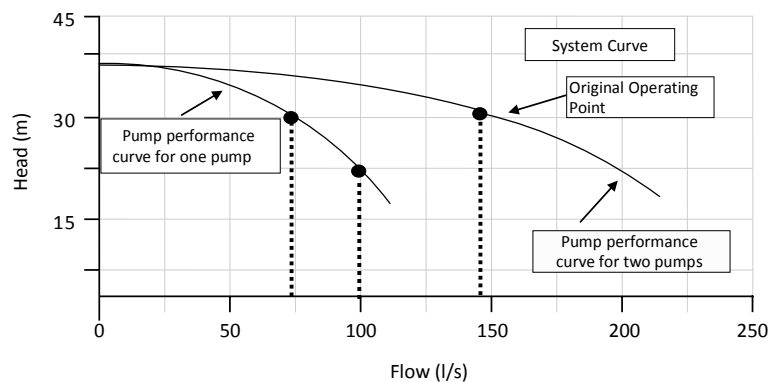
At 0.10/kWh, these savings are valued at 20 000 USD/Euro per year

*Remark: Using the affinity laws like above is an approximation that can lead to errors. It is better to consult the pump manufacturer to get the appropriate curves.*

**Example #2**

Consider a split case centrifugal pump that operates close to its best efficiency point (BEP) while providing a flow rate of 100 l/s at a total head of 22.5 m.

When an identical parallel pump is switched on, the composite system operating point shifts to 145 l/s at 32 m of head (see Figure 5.11). Each pump now operates at 80% efficiency, providing a capacity of 72.5 l/s while the fluid flow rate increases by 45%.



**Fig. 5.11.** Composite pump curve for two identical pumps in parallel

The static head is 15 m and the pump operates 4000 hours/year. The pump operates at an efficiency of 90% while pumping fluid with a specific gravity of 1.0. Combined motor and drive efficiency is 94%,

1. Calculate the electrical power required when one pump is operated.
2. Calculate the electrical power required by the pumping system when two pumps are in operation.
3. Calculate the Specific Energy for both cases using the following relationship:

$$SE_1 = \frac{\text{Energy Consumption (kWh)}}{\text{m}^3 \text{ pumped}} = \frac{\text{Power kW}}{\text{flow rate m}^3/\text{h}}$$

**Answer:**

1. Using the power equation for one pump:

$$\text{Power (W)} = \frac{\text{flow (l/s)} * \text{head(m)} * \text{density}}{102 * \eta_{\text{pump}} * \eta_{\text{motor}} * \eta_{\text{vsd}}}$$

$$\text{Power}_1 \text{ (W)} = \frac{100 \text{ l/s} * 22.5 \text{ m}}{102 * 0.90 * 0.94}$$

$$P_1 = 26.1 \text{ kW}$$

2. Using the power equation for two pumps:

$$\text{Power}_2 \text{ (W)} = \frac{145 \text{ l/s} * 32 \text{ m}}{102 * 0.80 * 0.94}$$

$$P_2 = 60.5 \text{ kW}$$

For fluid transfer applications it is useful to examine the Specific Energy (SE), the energy required per million liters of fluid pumped.

For operation with a single pump, the Specific Energy (SE) is:

$$SE_1 = \frac{\text{Power Consumption (W)}}{\text{Flow (m}^3\text{)}}$$

$$SE_1 = \frac{26100 \text{ W}}{100 \text{ l/s}} = \frac{26.100 \text{ kW}}{0.1 * 3600 \text{ m}^3/\text{h}} = 0.0725 \text{ kWh/m}^3$$

When both pumps are in operation, the Specific Energy increases to:

$$SE_2 = \frac{60.5 \text{ kW}}{0.145 * 3600 \text{ m}^3/\text{h}} = 0.116 \text{ kWh/m}^3$$

When operating both pumps in parallel, the electrical demand charge (kW draw) increases by 34 kW. If process requirements will allow the use of a single pump, the pumping energy use will decrease by 37%.

## 6. PUMP MAINTENANCE AND RELIABILITY

---

### 6.1. General

A large, and sometimes dominating, part of the *Life Cycle Cost* of a pump system is the maintenance cost. Several studies have shown that these costs can be controlled, or at the very least influenced, by the system design and how the pump is operated. The following will give some insights on what can be done in order to influence and better control these costs.

The maintenance costs are already significantly established in the design state when the engineer specifies the system design and the components of the system. The duty point at which the pump will operate, as well as the other specifications, will largely determine the reliability of the system, and hence the operating and maintenance costs.

Normally, the design process starts by establishing the purpose of the system, i.e. what is being pumped, at what flow rates, at what pressures, how, far, etc. The answers to these questions influence the choice of pipe diameters, control system, material selection, pump type, and so forth.

It must be remembered that at this point all calculations are theoretical and approximate. When the system is built and first started up, there will most certainly be deviations compared to the calculated values. Also, the duty point of the pump will differ from the one originally calculated.

Often the process demand will also change with time, resulting in different operating/duty points for the pump. In such cases, a new evaluation of the system should be made to ensure that the changes would not adversely affect reliability and maintenance costs.

The best way to ensure high reliability and low maintenance cost is to ensure that the system is properly designed for its intended purpose. It must also be operated as intended. Deviations from the intended duty point due to process changes or over-sizing in the design stage may lead to pump operation away from BEP, which, in turn, has negative consequences for the life of the system components. Modern control and monitoring systems can prevent pumps from operating under harmful conditions.

## 6.2. Factors that influence Reliability

Experience shows that the following factors frequently influence the reliability, and hence affect the maintenance costs of a pump system:

- Choice of pump type, including use of the proper material for the application
- Proper grouting and alignment (alignment should be made with filled pipes)
- Improper piping and inflow conditions
- Not enough NPSH
- Entrained air
- Dry running
- Operation outside of the permissible range
- Improper balancing
- Seals and bearings
- Bearing contamination, use of the wrong oil or grease
- Use of “pirated” parts and improper repairs
- Infrequent maintenance
- Lack of operator training

It is obvious that we have at least some degree of control over most of these factors. Following is a brief discussion of the various items.

### 6.2.1. Pump Types and Service

To start with, the specified pump must be suitable for the duty. The following International Standards give guidelines in this respect:

- ISO 9905 corresponding to API 610
- ISO 5199 covering most industrial applications
- ISO 9908 light duty applications

These standards provide engineers with an understanding of what pump characteristics are recommended for specific applications so that a chemical pump is selected for pumping certain chemicals, instead of trying to use a wastewater pump that may not have a suitable design for the application. There are, however, more factors that will influence the choice of a pump, which will be discussed in this Chapter.

### 6.2.2. Installation: Grouting, Alignment and Nozzle Loads

This subject is a science in itself. The Hydraulic Institute has published a new ANSI Standard called:

*American National Standard for Centrifugal and Vertical Pumps for Allowable Nozzle Loads (ANSI/HI 9.6.2-New)*

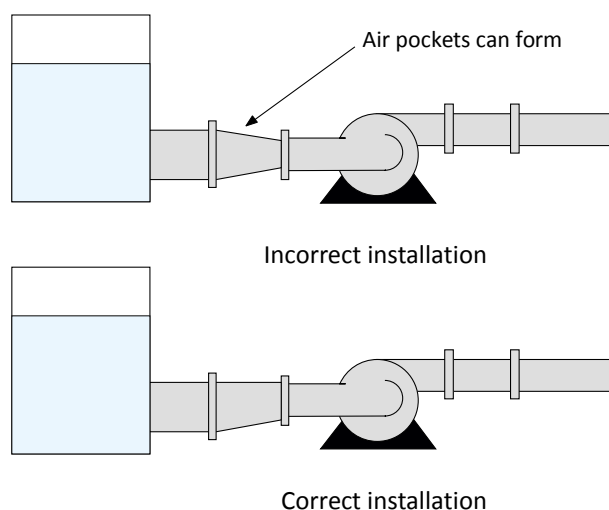
This Standard covers, among other things:



- Motor/pump coupling alignment
- Internal pump distortion
- Pump hold down bolts
- Pump mounting
- Nozzle stress
- Pressure-temperature considerations
- Pump materials
- Bedplate construction

It suffices to say that a proper installation is necessary for the pump to operate satisfactorily.

In addition to a proper pump installation, proper selection and installation of the piping and system components is critical to pump reliability. An example of this is shown in Figure 6.1.



**Fig. 6.1.** Suction pipe installation

### 6.2.3. Improper Piping and Inflow Conditions

Proper design of the piping system is an important factor for trouble-free operation. If the pipe diameter is too small for the desired flow rates this will cause high flow velocities and large pressure drops in the system. This means that the pump has to produce a higher than necessary pressure. The inlet pressure will in all likelihood be lower with the increased risk of having cavitation problems.

Bad or uneven inflow to a pump can also have dramatic effects on the performance of the pump. The inflow should be as even as possible. Vortices must be avoided at all cost. 80% of pump problems are system problems and 80% of those are suction system problems.

### 6.2.4. NPSH

NPSHR is a measure of the pressure that is required at the inlet of the impeller in order to avoid cavitation damage during operation of the pump. NPSHA is the available pressure, which has to be higher than the required pressure NPSHR. It must be pointed out that curves indicating the NPSH requirement of a pump often refer to a “3% drop” in pressure relative to cavitation-free performance.

EUROPUMP and HI have published Standard ANSI/HI9.6.1 1998 (currently being revised) for NPSH margins that give the user suggested margins of NPSHA over NPSHR.

### 6.2.5. Entrained Air

It is important to avoid entrained air in the pumped media as much as possible. Entrained air causes damage similar to cavitation in the pump. It can also be the origin of severe noise problems. Some of the time a small amount of air quiets a pump. Centrifugal pumps can only handle 3-5% air before performance deteriorates.

### 6.2.6. Dry Running

Dry running, or running against a closed valve, can cause enormous heat buildup in the pump, seizure of parts, and, in a worst-case scenario, lead to an explosion. Proper monitoring of the system should be in place to avoid this situation. Figure 6.2 shows what can happen when a pump is operated against a closed valve for an extended period.



**Fig. 6.2.** Explosion due to closed valves on both sides of a pump

### 6.2.7. Allowable Operating Region

Every centrifugal pump has a best efficiency point, which is marked on its pump curve. This is the design point for the pump. At this point, the efficiency reaches its maximum and the forces on the bearings are generally the lowest. When the pump is operated away from the BEP the efficiency goes down.

Due to the fact that the harmful hydraulic forces in the pump increase rapidly when the pump is operated away from the best efficiency point, each manufacturer assigns an “allowed or recommended operating region” around the BEP. If the pump operates outside this region for an extended period of it can be damaged.

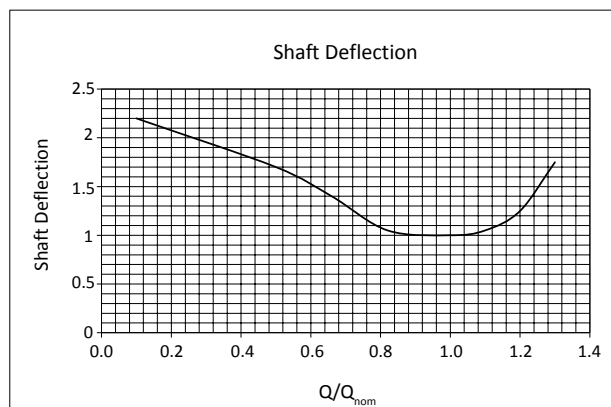
The system designer has to calculate a system curve that will be used to choose the right pump for the required duty. The system curve determines where on the pump curve the pump is operating.

What is even more important from reliability and maintenance point of view is that the hydraulic forces in the pump increase rapidly, which can affect the shaft deflection as shown in Figure 6.3.

Changes in the duty point can be made both by varying the system curve, i.e. by throttling, and by varying pump performance by changing the speed of the pump. It must be remembered that the real duty point, in all likelihood, will be different from the calculated duty point; therefore, adjustments should be made, if possible, when the system is commissioned. With time, processes are usually changed, which also results in changes in duty point for the pump.

Pumps in the process industry are often regulated with valves. One common occurrence is that the operators want to increase production, which leads them to open the control valves in order to increase flow rates. In such cases, care must be taken so that the pump does not run too far on the curve in cavitation mode or create excessive loads on the bearings.

**Fig. 6.3.** Typical shaft deflections due to radial forces





### 6.2.8. Seals and Bearings

At the BEP, the hydraulic loads imposed on the impeller are minimized and are usually fairly steady. At flows greater or less than the BEP, the hydraulic loads increase in intensity and become unsteady because of turbulence and/or re-circulation in the impeller and casing. These unsteady loads have a negative affect on both the seals and the bearings of a pump.

Figure 6.4 shows how bearing loads and shaft deflection can vary with flow rate for a volute-type, centrifugal pump. This shows how dramatic the influence of the operating point can be on bearing life. Seal life in turn is very dependent on shaft deflection.

Contamination of the bearings can drastically shorten bearing life and lead to failure. The bearings should, therefore, be well protected from all types of contaminants. Also, it is of the utmost importance that the bearing manufacturers' recommendations regarding oil or grease types are followed.

Relatively recent tests have shown that any type of external fluid that enters the grease in a roller bearing will rapidly lead to deterioration of the grease or oil. Deteriorated grease, in turn, is transferred out of the bearing by its movement, which leads to rapid failure. It is, therefore, extremely important that a greased bearing is protected from all kinds of water intrusion or the pumped fluid.

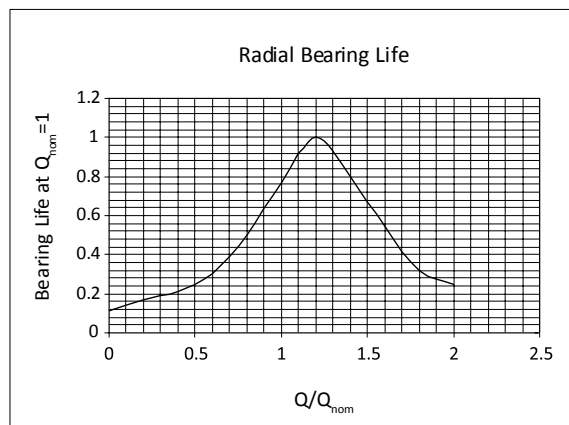


Fig. 6.4. Typical radial bearing life as a function of normalized flow rate

### 6.2.9. Use of “Pirated” Parts and Improper Repairs

In order to maintain the quality of the pump system, it is essential that original parts be used for repairs. This includes items like bearings, where the manufacturers' recommendations should be strictly followed.

### 6.2.10. Improper Balancing

It is self-evident that improper balancing of rotating parts leads to increased forces of the bearings and, therefore, also shortened bearing life. *ANSI/HI Standard 9.6.4 –New - and ISO Standards* contain recommendations for maximum unfiltered vibration limits for pumps with either journal or rolling contact bearings. Pump manufacturers have found, by experience and theoretical analysis, that there are no adverse affects on pump life or reliability due to vibration forces, so long as the vibration amplitudes do not exceed these limits. Reputable manufacturers will ensure that their products are balanced to these standards.

Some foreign object in the pumped media can, however, damage an impeller during operation. It is, therefore, a good idea to monitor vibration levels to make certain that the pump is in good condition.



### 6.2.11. Effect on Maintenance by Operating Away from BEP

The reliability and, hence, maintenance costs are very dependent on where on its curve the pump is operated. Figure 6.5 shows how the reliability varies with distance from the best efficiency point (BEP). As can be seen, even small deviations from BEP have major influence on the reliability.

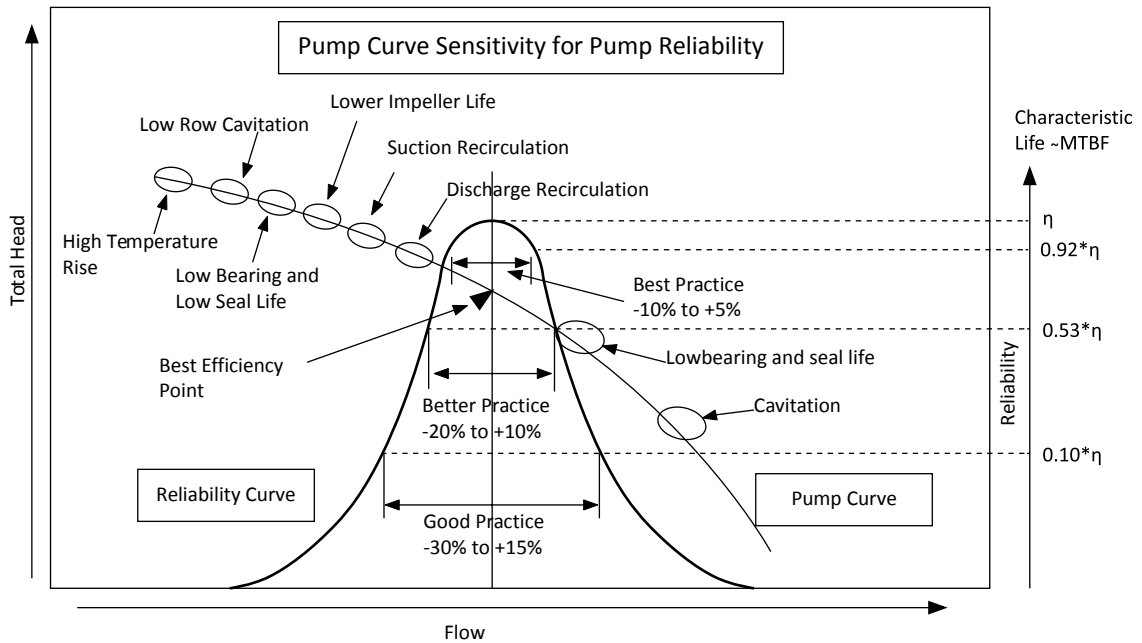
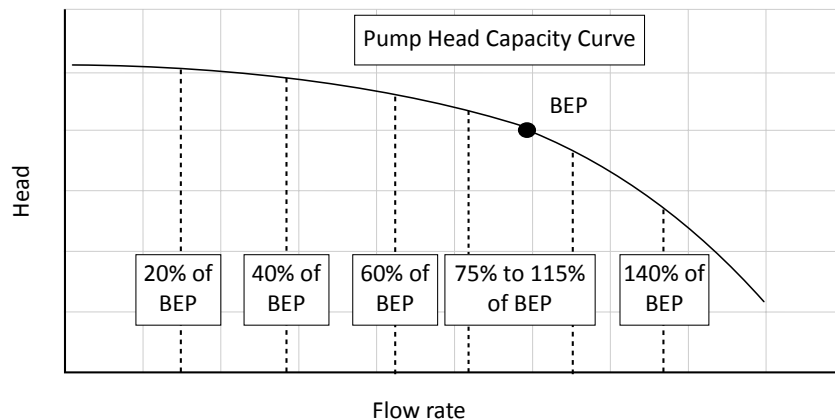


Fig. 6.5. Reliability as a function of distance from BEP

### 6.2.12. Maintenance Cost Relative to Distance from BEP

When a pump is operated away from its BEP, the forces from the fluid on the impeller in the pump increase rapidly. As bearing life depends on the forces the bearings have to support, bearing life will also be affected (as shown in Figure 6.4) and the increased forces cause increased shaft deflection (as seen in Figure 6.3) which has a very negative influence on seal life. If the operating point deviation from the BEP is large, there may also be vibrations due to cavitation or recirculation in the impeller. The more unstable fluid flow can then damage the impeller and shorten its life. Table 6.1 shows an example from the Chemical industry of how maintenance cost can be influenced by operating point.



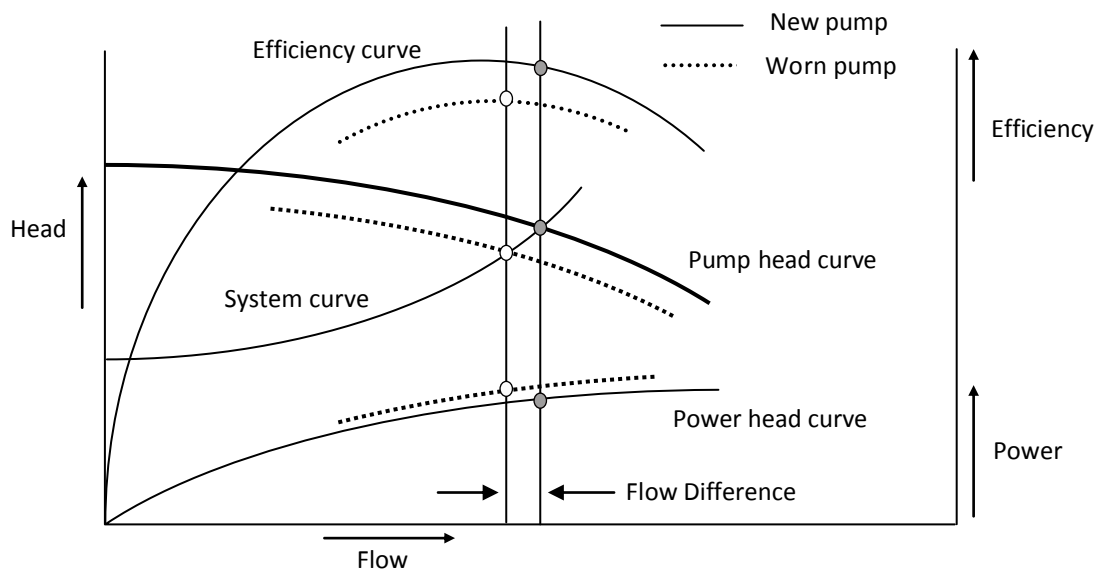


**Table 6.1.** Example of how maintenance costs can vary with distance from BEP

		% of Best Efficiency Point					Cost/Failure (USD/Euro)	
		20%	40%	60%	75% to 115%	140%		
<b>Seals</b>	Life	2 months	4 months	1 year	2 years	2 months	1000	Parts
	Failure/Year	6	3	1	0.5	6	500	Labor
	Cost/Year (USD/Euro)	9000	4500	1500	750	9000		
<b>Bearings</b>	Life	1 year	3 years	4 years	5 years	1 year	500	Parts
	Failure/Year	1.00	0.33	0.25	0.20	1.00	500	Labor
	Cost/Year (USD/Euro)	1000	333	250	200	1000		
<b>Casing/ Impeller</b>	Life	2 years	5 years	7 years	10 years	2 years	2000	Parts
	Failure/Year	0.50	0.20	0.01	0.10	0.5	0	Labor
	Cost/Year (USD/Euro)	1000	400	285	200	1,000		
<b>Total Cost/Year (USD/Euro)</b>		<b>11 000</b>	<b>5230</b>	<b>2040</b>	<b>1150</b>	<b>11 000</b>		

### 6.2.13. Effect of Pump Wear on Pump Characteristics

After being in service for a period of time, pumps may require adjustments to maintain original efficiencies. Depending on the type of pump, this may be done by adjusting wear plates or distance between the impeller and the pump bowl. If adjustments are not done at specified intervals, the pump characteristics may change and the pump may be operating outside its recommended operating region. It is good practice to benchmark the pump after startup of a pumping system and perform periodic testing to discover any deviations. An example of how a worn pump may affect pump characteristics is shown in Figure 6.6.



**Fig. 6.6.** Effect of worn pump on pump characteristics

Pumps wear in different ways. Although efficiency, flow and pressure are almost always reduced, power may increase or decrease depending on the pump. This is important to recognize as pumps used for systems such as irrigation may increase power consumption when pump efficiency is improved, if the pumps are still operated for the same amount of time (and pumping more flow). With these systems, the pumps should be operated for less time to benefit from the increased pump efficiency.

Maintaining the appropriate clearances between the bottom of the vanes of a semi-open impeller and the bowl housing is necessary for efficient pump performance, as shown in Figure 6.7, for a vertical well pump.

Pump adjustments for vertical, turbine pumps with semi-open impellers can be done by adjusting a nut on the top of the shaft to lower the impeller. However, this technique will not work for pumps that have enclosed impellers.

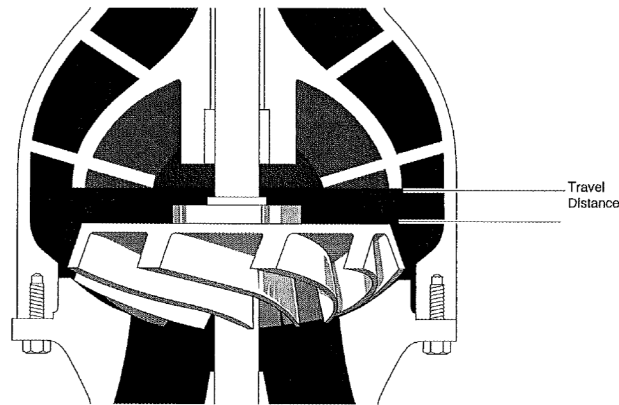


Fig. 6.7. Travel distance for a vertical turbine pump

### 6.3. Pump System Monitoring

Maintenance practices vary significantly from one facility to another. The key areas for any maintenance department should include the following:

- Have adequate, skilled staff to keep up with equipment repairs and preventative maintenance
- Have the right equipment, tools and spare parts available
- Perform maintenance functions in a systematic and efficient manner
- Understand that they are part of a team and need to support facility operations
- Work with facility management to integrate maintenance activities into an efficient “asset management program”
- Have trained supervisors that plan maintenance activities efficiently
- Balancing corrective, predictive and preventive maintenance costs effectively

A maintenance maturity matrix in Table 6.2 published in *Computerized Maintenance Management Systems* by Terry Wireman provides an overview of different maintenance levels.



**Table 6.2.** Example of maintenance maturity matrix

Measurement Category	Stage 1 Uncertainty	Stage 2 Awakening	Stage 3 Enlightenment	Stage 4 Wisdom	Stage 5 Certainty
<b>Corporate/ Plant Management Attitude</b>	No comprehension of maintenance prevention; fix it when it's broken	Recognizes that maintenance could be improved, but is unwilling to fund	Learns more about ROI; becomes more interested and supportive	Participative attitude; recognizes management support is mandatory	Includes maintenance as a part of the total company system
<b>Maintenance Organization Status</b>	REACTIVE: works on equipment when it fails; otherwise very little productivity	CONSCIOUS: Still reactive but rebuilds major components and has spares available when failures occur	PREVENTIVE: Uses routine inspections, lubrication, adjustments, and minor service to improve equipment MTBF	PREDICTIVE: Utilizes techniques such as vibration analysis, thermography, NDT, sonics, etc. to monitor equipment condition, allowing for proactive replacement and problems solving instead of failures	PRODUCTIVE: Combines prior techniques with operator involvement to free maintenance technicians to concentrate on repair data analysis and major maintenance activities
<b>Percentage (%) of Maintenance Resources Wasted</b>	30+%	20-30%	10-20%	5-10%	Less than 5%
<b>Maintenance Problem Solving</b>	Problems fought as they are discovered	Short-range fixes are provided; elementary failure analysis begins	Problems solved by input from maintenance, operations, and engineering	Problems are anticipated; strong team problem-solving disciplines are utilized	Problems are prevented
<b>Maintenance Workers, Qualification and Training</b>	Poor work quality accepted; rigid craft lines; skills outdated; skills training viewed as unnecessary expense; time in grade pay; low worker turnover/apathy	Workers' lack of skills linked to breakdowns; trade/craft lines questioned; skills obsolescence identified; training needs recognized; traditional pay questioned	Quality + Quality = Quality; expanded/shared job roles; a few "critical skills" developed; training expenses reimbursed; new pay level for targeted skills; increased turnover/ fear of change	Quality work expected; "multiskill" job roles; skills up to date and tracked; training required and provided; pay for competency progression	Pride and professionalism permeate; work assignment flexibility; skilled for future needs; operators trained by maintenance, ongoing training; percent of pay based on plant productivity; low employee turnover/high enthusiasm
<b>Maintenance information and Improvement Actions</b>	Maintenance tries to keep records, disciplines are not enforced, poor data	A manual or computerized work order system is used by maintenance; little or no planning or scheduling	A manual or computerized work order system is used by maintenance, operations, engineering, planners	A computerized maintenance control system is used by all parts of the company; information is reliable and accurate	A maintenance information system is integrated into the corporate operation
<b>Summation of Company Maintenance Position</b>	"We don't know why the equipment breaks down; that is what we pay maintenance for. Sure, our scrap rates are high, but that's not a maintenance problem."	"Do our competitors have these kinds of problems with their equipment? Scrap is costing us a bundle!"	"With the new commitment from management, we can begin to identify and solve problems."	"Everyone is committed to quality maintenance as a routine part of our operational philosophy. We can't make quality products with poorly maintained equipment."	"We don't expect breakdowns and are surprised when they occur; maintenance contributes to the bottom line!"

At the minimum, operators should follow the manufacturers' recommended maintenance schedule and do periodic walk downs to listen for unfamiliar noises and feel the vibrations. In this way, a good operator can catch many problems before they reach a serious stage.

Monitoring the system and looking for deviations in vibration patterns can also be a good way of discovering problems before they lead to serious problems.

### 6.3.1. Asset Management

There are several ways to increase the life, reliability and productivity of a system. To manage the system in order to get optimal value out of it is called Asset Management.

The key to achieving this is to ensure that the system is always operated in accordance with the intentions of the designer. There are many new products available on the market that can help achieve this goal, and more are constantly coming. A number of such products / methods are described below:

### 6.3.2. Monitoring Systems

Monitoring systems have been around for many years and, with falling prices on electronic components, are becoming increasingly sophisticated. Monitoring of flow rate, pressure, temperature, *rpm*, vibration levels, etc. are common. These systems can discover deviations from normal operating conditions, but it is still up to the operator to ensure that the pump is operated as intended.

### 6.3.3. Integrated Monitoring and Control Systems

The latest development in the monitoring and control of pump systems integrates these functions. The output from monitoring sensors is fed into a small computer, which uses specific algorithms to control pump operation by changing its speed.

One such system can perform the following tasks:

- Prevents the pump from running against a closed discharge valve
- Prevents the pump from running with a closed suction valve
- Prevents dry running
- Prevents running in cavitation mode
- Restricts operation to customer-specified operating ranges
- Reacts and “alarms” at process system upsets
- Enables the customer to maintain flow pressure or other process variables
- Possesses self-diagnostic capabilities that alert the user when the pump is in need of maintenance, i.e. adjustment of clearances

## 6.4. Key Learning Points

Key learning points for this chapter includes:

- Maintenance costs are basically decided on when the system is designed. From the above, it is evident that the way in which the pump system is operated is the real key to increased reliability and lower maintenance costs.
- It is of the utmost importance that the pump is operated as close as possible to the BEP. Over sizing of the pump frequently leads to excessive throttling of the flow by a valve. This, in turn, results in a change in the duty point, normally towards shut-off.



- Proper installation is very important for trouble free operation.
- All facilities should strive to put together a comprehensive maintenance program.
- The Manufacturers' recommended service intervals should be adhered to.
- Advanced monitoring and control system can protect and extend the life of the system.

## 6.5. Exercises

### Example #1

Pump efficiency tests indicate that a 150 kW water pump operating with a variable speed drive produces 400 l/s at 15 m of total head at 80% of full speed. An electrical measurement shows that the pump draws 110 kW. The pump operates 6000 hours per year at a cost of 0.05 USD/Euro per kWh. Demand cost is 10.00 USD/Euro per kW, motor efficiency is 90%, vsd efficiency is 95%, and the original pump efficiency is 85% at the same flow rate and head.

1. Calculate the existing pump efficiency.
2. Determine the cost savings if the pump was restored back to its original condition.

### Answer:

Use the pump equation to first calculate the existing efficiency:

$$kW = \frac{\text{flow (l/s)} * \text{head(m)}}{102 * \eta_{\text{pump}} * \eta_{\text{motor}} * \eta_{\text{vsd}}}$$

Solving for Pump Efficiency ( $\eta_{\text{pump}}$ ):

$$\text{Pump Efficiency} = \frac{400 \text{ l/s} * 15 \text{ m}}{102 * 110 \text{ kW} * 0.90 * 0.95} = 0.62$$

Next, use the pump equation at the same flow rate and head but with the original pump efficiency (vsd speed will be lower at the higher efficiency since the pump can produce the same flow at the same head using less power).

$$kW = \frac{400 \text{ l/s} * 15 \text{ m}}{102 * 0.85 * 0.90 * 0.95} = 81 \text{ kW}$$

$$110 \text{ kW} - 81 \text{ kW} = 29 \text{ kW}$$

$$\text{Annual Demand savings} = 29 \text{ kW} * 10.00/\text{kW} * 12 \text{ months} = 3480 \text{ USD/Euro}$$

$$\text{Annual kWh Savings} = 29 \text{ kW} * 6000 \text{ hours} * 0.05 \text{ per kWh} = 8700 \text{ USD/Euro}$$

$$\text{Total Cost Savings: } 12 \text{ } 180 \text{ USD/Euro}$$



## 7. PUMP SYSTEM ENERGY USE

### 7.1. General

In Chapter 4, the relationship between fluid power, pressure (head) and the specific gravity of a fluid was discussed. This Chapter expands on this concept by adding mechanical and electrical component efficiencies to the equation, and translating it into kilowatts and energy dollars.

### 7.2. Power Equations

When the equation for fluid power is expanded to include equipment efficiency, the corresponding relationship will be similar to equation 7.1. As noted for the metric equations, kW includes an “electric power” subscript to distinguish this kW from the kW used in Chapter 4 to represent fluid power.

<u>U. S. Units</u>	
$kW$	$= \frac{\text{Head (ft)} * \text{Flow (gpm)} * \text{specific gravity} * 0.746}{3960 * \eta_{\text{pump}} * \eta_{\text{motor}} * \eta_{\text{asd}}}$
<u>Metric</u>	
$kW_{\text{electric power}}$	$= \frac{\text{Head (m)} * \text{Flow (m}^3/\text{sec)} * \text{density} * 9.8}{\eta_{\text{pump}} * \eta_{\text{motor}} * \eta_{\text{asd}} * 1000}$
$kW_{\text{electric power}}$	$= \frac{\text{Head (m)} * \text{Flow (m}^3/\text{hr)} * \text{density}}{367 * \eta_{\text{pump}} * \eta_{\text{motor}} * \eta_{\text{asd}} * 1000}$
$kW_{\text{electric power}}$	$= \frac{\text{Head (m)} * \text{Flow (liters/hr)} * \text{density}}{102 * \eta_{\text{pump}} * \eta_{\text{motor}} * \eta_{\text{asd}} * 1000}$

**Eq. 7.1.** Electric Power Equations



Besides including pump efficiency, the electric power equations, shown in Equation 7.1, also include electrical efficiency values for the motor and variable speed drive (vsd). Depending on the pump system, these components will vary and can be adjusted as needed. The important aspect to recognize is that every component between the electric meter and the pump should be included if efficiency is being reduced. This is illustrated in Figure 7.1.

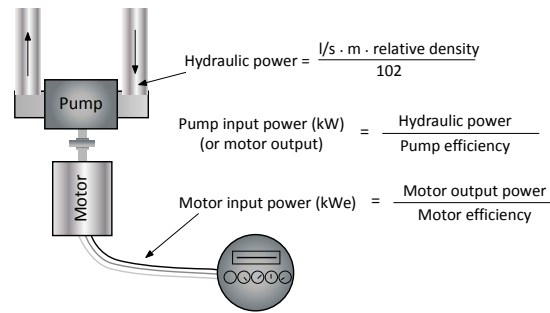


Fig. 7.1. Breakdown of Energy Equation

### 7.3. Using the Power Equations

The electric power equations are extremely useful to evaluate pump system energy use. When properly used, these equations provide a kW value for any point that the pump is capable of operating at. Some of the ways these equations can be used include:

- Evaluating energy savings when pump or motor efficiency is improved
- Comparing field data with calculated data to verify results
- Evaluating the impact of reducing or increasing total head or flow

It is important to remember that the electric power equations must also account for efficiency changes when flow or head are changed. Using a pump curve and system curve will help determine pump efficiency changes.

Obtaining a kW value for each operating point that the pump is expected to operate at is the first step to evaluate pump system energy use. Using this value, kWh can be easily determined by multiplying each calculated kW value by the number of hours the pump is expected to operate at that interval. At this point it appears to be simple math to then multiply the number of kWh by the cost/kWh to get a total energy cost. However, most utility rate schedules are far more complicated and must be reviewed in detail to determine the true monthly energy cost.

### 7.4. Specific Energy

It is very useful to be able to track the performance of a system in order to see how efficiently it is operating relative to optimum, but also to be able to easily and quickly discover deviations from the normal. When monitoring systems, it is therefore desirable to be able to measure some parameters that give an indication of how the system is performing and if the performance changes over time.

Pump systems in industry are often connected to various types of monitoring and control systems. Traditionally, flow rate, pressure, power or current are monitored. Just monitoring one or several of these entities is, however, not enough to get a good picture of the system performance. However, in many cases the information collected can be made more useful if different parameters are combined to form key performance indicators that are followed in time. Monitoring of pumps can, for example, be made more useful by dividing the flow and power to form specific energy, rather than just measuring them independently.



The specific energy is a very useful key performance indicator to follow and monitor pump systems.

The U.S. Department of Energy's PSAT Programme can be used together with the specific energy concept to construct a diagram that shows total system performance relative to an optimal system. This diagram makes it easy to demonstrate the optimization potential both as a function of improving the existing system components and as a function of eliminating throttling losses. The diagram also shows how the cost of pumping is affected by such changes to the system.

When judging how a pumping system performs, energy wise, it is important to know what to measure. A pump can operate at high efficiency, whereas the system as a whole operates at low efficiency. This is particularly common when throttling valves control the system. Very large amounts of energy can be wasted in a heavily throttled system.

A common reason why excessive throttling takes place is over-sizing. It should not be a surprise to anyone that most pump systems are oversized. It is hard to make accurate calculations of the required head and rate of flow that have to be delivered by pumps. Safety margins are therefore usually added during the design phase. Add to that, that flow resistance often increases with time as well as that flow requirements are often increased in the future and it is easy to understand that most systems are oversized and capable of providing more flow than needed. Throttling valves and Variable Speed Drives are frequently used to correct over-sizing.

It is important that an operator or plant manager understands how efficiently the pump systems in a plant work. To answer this question it is common practice to perform a system assessment where the actual process demands are compared to the available supply and suggestions for how the system can be improved are put forward.

After a system has been optimized, it is important to make sure that the achieved improvements are maintained and that the system efficiency is not allowed to slip. The specific Energy can be used as a Key Performance Indicator (KPI) in order to investigate and follow system efficiency and to make sure deviations in system performance get detected at an early stage.

It is very useful to be able to track the performance of a pump system in order to see how efficiently it is operating relative to optimum, but also to be able to easily and quickly discover deviations from normal. Monitoring the performance of pumping systems can be a very profitable undertaking.

Pump systems in industry are often connected to various types of monitoring and control systems. Traditionally, flow rate, pressure, power or current are monitored. Just monitoring one or several of these entities is, however, not enough to get a good picture of how the system is performing. There is also risk of missing important information about system performance as a whole. In many cases, the information collected can be made more useful if different parameters are combined and followed in time. The monitoring of pumps can, for example, be made more useful by relating the flow and power, rather than just measuring them independently. It is shown that power divided by flow rate is a very important key performance indicator for a pump system.

In many industries motor current is monitored instead of power. The current is roughly proportional to power and can be used as a substitute for power. In both cases, the



quotient will be a very good measure of the system efficiency and also sensitive to changes in the system.

In order to explain how this KPI is derived, and the benefits it brings, some fundamental relationships must first be described.

### 7.4.1. Fluid Power

For pump systems, the relationship between fluid power, flow rate, pressure (head), and specific gravity of the fluid can be expressed in the following equation:

$$\text{Fluid Power} = \text{Head (m)} * \text{Flow (m}^3/\text{sec)} * \text{specific gravity} * 9.8 \quad (1)$$

In order to obtain the electrical power used by the system, it is necessary to divide the fluid power by the efficiencies of the different components that produce the fluid power: i.e. motor, pump and if present, variable speed drive, VSD, efficiencies.

### 7.4.2. Specific Energy calculations

A useful measure for calculating the cost of pumping is the specific energy,  $E_s$ , which is defined as the energy used to move a certain volume through the system. Specific energy is measured as Watt *hours*/m<sup>3</sup> or any other suitable unit and has the advantage of being a direct measurement of the cost of pumping, once you know the cost of energy.

$$\frac{\text{Energy used}}{\text{Pumped Volume}} = \text{Specific Energy} \quad (2)$$

$$E_s = \frac{P_{in} \cdot \text{Time}}{V} = \frac{P_{in}}{Q} \quad (3)$$

As seen in equation (3), the instantaneous value of the specific energy equals the input power divided by the flow rate.

Using the equation for fluid power and dividing by the various efficiencies we get:

$$\text{InputPower} = \frac{\text{Head (m)} * \text{Flow (m}^3/\text{sec)} * \text{specific gravity} * 9.8}{\eta_{pump} * \eta_{motor} * \eta_{drive}} \quad (4)$$

From this we get:

$$E_s = \frac{\text{Head (m)} * \text{specific gravity} * 9.8}{\eta_{pump} * \eta_{motor} * \eta_{drive}} \quad (5)$$

If there is no variable speed drive in the system, the corresponding term equals 1.

Specific Energy is hence a linear function of head if the efficiencies are constant. It is a useful measure for comparing different system solutions and the cost of pumping.

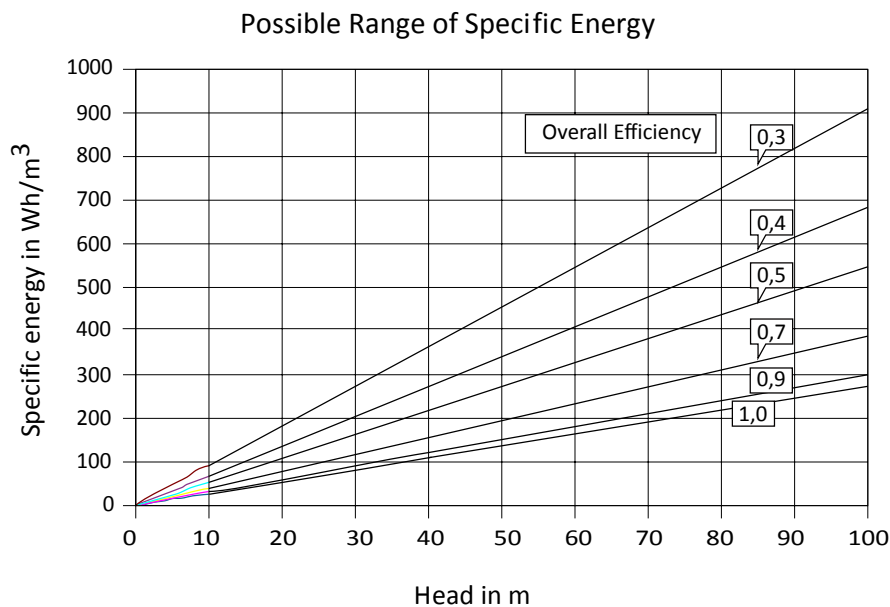
In systems where the flow is constant this is a simple task by using the equations above. In systems with varying flow rates it becomes a little more complicated. First,  $E_s$  needs to be calculated as a function of flow rate, which requires information from pump, motor and drive manufacturers. The pump manufacturer has to provide pump curves for variable speed operation, while the motor and drive suppliers have to provide efficiency curves as a function of load and speed.

In existing systems, specific energy can be calculated directly from measurement of absorbed energy and flow rate.

Specific Energy,  $E_s$ , is a linear function of the head if the other factors are constant. We can, therefore, plot  $E_s$  as a function of head for different overall efficiencies. See figure 7.2, where the overall efficiency is the product of the different component efficiencies from Eq. 5. The lowest line in the diagram represents 100% efficiency and is of course not reachable. If input power, flow rate and head are available at a specific duty point, it is easy to calculate  $E_s$  and mark that as a point in figure 7.2. The overall system efficiency can then be interpolated.

Using a computer program, such as US Department of Energy’s PSAT, the best available pump and motor efficiencies for specific duty point can be found and a lowest possible specific energy can be calculated for the duty point in question, if there is no VSD involved. It is harder to find out what the efficiency of a drive/motor combination is as it varies depending on how well motor and drive fit together. The drive, if present, introduces additional losses in the motor that should be accounted for.

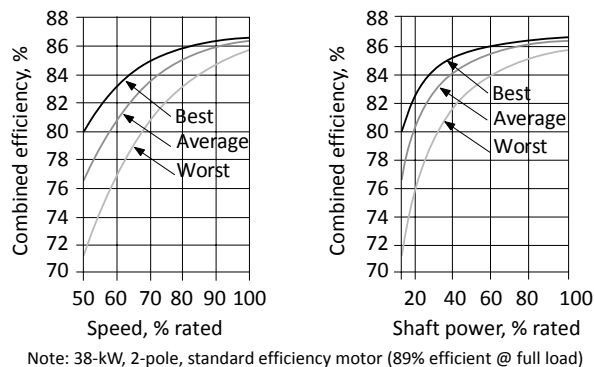
Figure 7.3 gives an idea about the combined efficiency of a drive and motor. Motors react differently to different drives. It is therefore recommended to buy a drive and motor from the same manufacturer to assure a combination that is well matched. Modern drives have improved considerably compared to what was available some years ago, but they still influence motor efficiency and this should be accounted for.



**Fig. 7.2.** Specific energy as a function of head for different overall efficiencies ( $= \eta_{drive} * \eta_{motor} * \eta_{pump}$ )



One of the benefits with using PSAT is that the programme has included information about the kind of pump that is used and information about the best available pump efficiency for many kinds of pumps is stored in the program. The Hydraulic Institute, HI, has made the data available.



**Fig. 7.3.** Combined motor / drive efficiency when attached to different drives, (DOE)

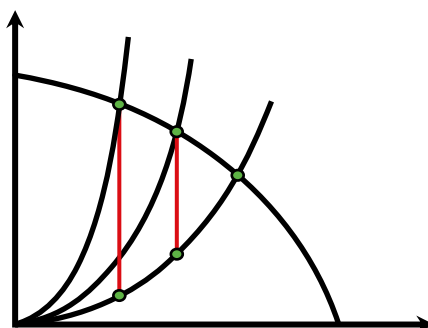
### 7.4.3. Flow control

The two basic methods for flow control are: to either change the system curve, by throttling, or the pump curve, by using a variable speed drive. The most common option is still the use of a throttling valve. Variable speed drives are always more efficient than throttling valves, and they will usually be more economical to use than valve regulation, especially on a life cycle cost comparison. Controlling the rate of flow by by-passing some of the pumped liquid is also used in many applications in spite of its being uneconomical.

In systems where precise flow control is not needed, other solutions than throttling valves or VFDs may prove to be more efficient. For example, properly sized pumps running on/off can be a very efficient solution for many systems.

### 7.4.4. Flow Regulation by Throttling

When the flow is regulated using a throttling valve, the system curve is changed. The duty point moves to the left on the pump curve when the flow is throttled, see Figure 7.4. The vertical red line in Figure 7.4 represents throttling losses in the valve. The specific energy  $E_s$  can be calculated for each operating point by dividing the input power to the motor by the flow rate.  $E_s$  usually increases rapidly as throttling reduces the flow. The reason for this is two fold, the losses in the valve and frequently falling pump efficiency higher up on the pump curve.



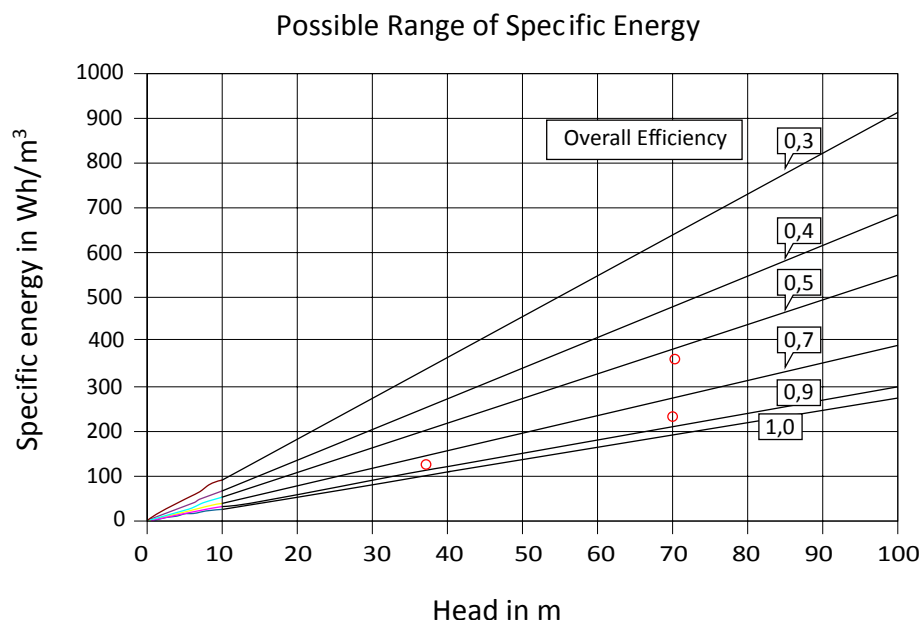
**Fig. 7.4.** Throttling a valve changes the flow rate by adding the pressure drop in the valve to the system losses. The new system curve will be steeper and the operating point moves up along the pump curve.

From the information in Figure 7.4, it is possible to estimate the head that would be necessary to produce a certain flow in the system if there would be no throttling. (One method of getting the pump to operate at such an un-throttled duty point would be to use a variable speed drive to reduce the pump output instead of throttling the pump). The head requirement without throttling can be read on the original un-throttled curve below the desired operating point. Again PSAT can be used to estimate the efficiency of the best possible motor/pump combination for this un-throttled rate of flow.

Using PSAT, the ideal specific energy for this un-throttled operating point can thus be calculated and plotted in the specific energy diagram. This has been done in Figure 7.5. The top right point represents the present operating point. The lower right point represents the specific energy, using an optimal motor/pump combination, obtained from PSAT. The lower left point represents an optimal pump/motor combination operating without throttling. The diagram gives a very good graphical representation of where the system is operated from a cost point of view and where it could operate if optimized and without throttling losses.

As there is a cost associated with each kWh, the y-axis shows the cost of pumping a unit volume through the system. The example in figure 7.5 thus shows that the specific energy can be lowered from  $360 \text{ Wh/m}^3$  to  $240 \text{ Wh/m}^3$  by improving the pump and motor. A further reduction to  $120 \text{ Wh/m}^3$  is possible by removing the throttling losses.

The people responsible for the system can thus easily see that they are using three times as much energy and money as they need to do to perform a certain duty. Changes in pump performance will also be much easier to detect than if power and flow are monitored independently.



**Fig. 7.5.** Specific Energy Diagram with Three Operating Points.



### 7.4.5. Flow Regulation Using Variable Speed Drives

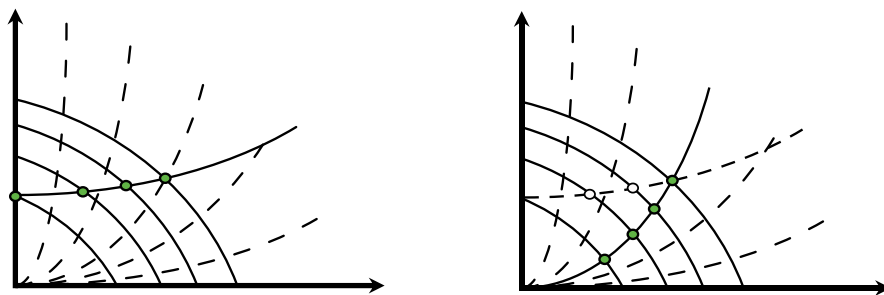
A variable speed drive makes it possible to adjust the output to the demand without throttling. The common over-sizing of pumps can therefore often be neutralized and large amounts of energy saved. In the case of systems exhibiting a large amount of static head, however, special care has to be taken. When the speed is reduced in such a system the operating point moves higher and higher on the reduced pump curves, until the pump finally is dead-headed. It should be stressed that long before that happens, the pump leaves the preferred operating range and can experience severe damage if operated under such conditions for an extended period of time. It is therefore necessary to take a broad view of the system before deciding on what kind of control to use.

Variable speed pumping can save a tremendous amount of energy relative to throttling, but is not always the best solution to a pumping problem. Variable Speed Drives sometimes actually increase the energy consumption. It is therefore important to understand when to use them and when not to use them. This has been described in an earlier eemods (Energy Efficiency in Motor Driven Systems) paper.

Figure 7.6 shows two system curves and reduced pump curves (solid lines) and lines of constant efficiency (dashed lines), the middle one having the highest efficiency. It demonstrates what happens in a speed-regulated system. Here new pump curves are obtained as the speed is decreased. New operating points will be determined by the intersection of the system curve and a reduced pump curve. It is important to separate systems *with* and systems *without* static head as they react quite differently to speed changes.

In a system with static head, the pump efficiency will change as the speed is changed. In systems without static head, on the other hand, the new operating points obtained when the speed is reduced will remain at the original efficiency as shown in Figure 7.6.

Due to the above, it is a bit more complicated to use the specific energy diagram with speed control. If the best possible efficiency is to be plotted in the diagram, the changes in efficiency with speed for all the system components have to be considered. This could be done for a limited number of points, where after the points are connected. The instantaneous energy use and flow rate can still be monitored and compared to the optimum in the diagram. A system with static head might look like the curve in figure 7.6.



**Fig. 7.6.** With a VSD, the operating point moves along the system curve. The figures show two different system curves, one with static head and one without.

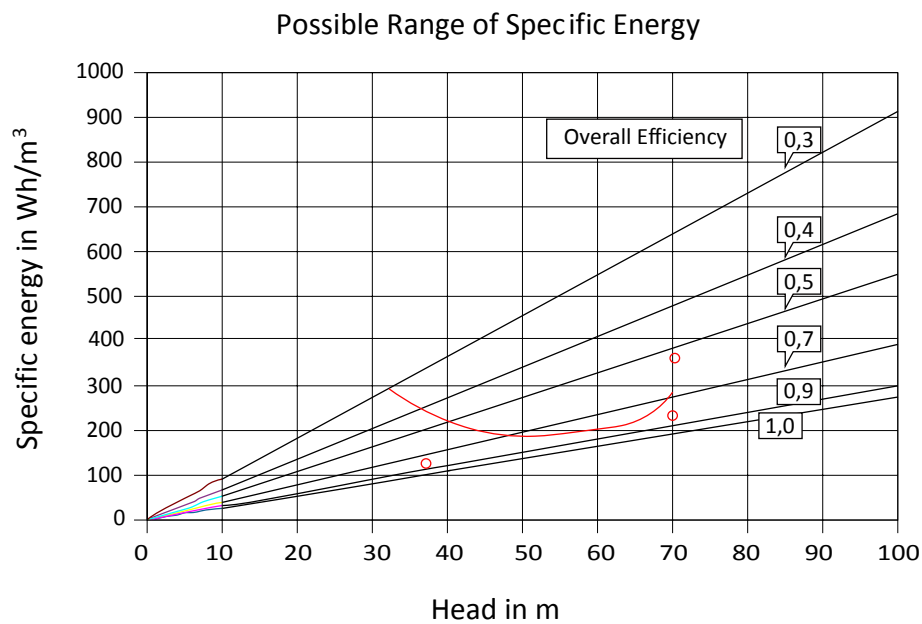
### 7.4.6. Specific energy as a Key Performance Indicator, KPI

It is very useful to be able to track the performance of a pump system in order to see how efficiently it is operating relative to optimum, but also to be able to easily and quickly discover deviations from the normal. It is suggested that power divided by flow rate would be a very useful key performance indicator if flow rate and power were monitored.

In many industries motor current is monitored instead of power. The current is roughly proportional to power and can be used as a substitute for power. As the power factor changes with motor load, this has to be taken into account when using the current instead of power. It has to be realized that if the current is used, it will not give a correct measure of the specific energy without being converted to power. PSAT has the capability of doing this with fairly high accuracy as long as the motor is not very lightly loaded (below 25%). However, if the current is used instead of power, the quotient will still be sensitive to changes in the specific energy and could thus be used for detecting performance changes. In both cases the quotient will be a very good detector of changes in the system efficiency.

At a recent assessment of a pump station, it was found that one of the three parallel pumps was drawing about 100kW but contributed almost nothing in flow. The pump was practically dead-headed by the other two pumps as the wear rings were badly worn and the delivered head was therefore lower than for the other pumps.

The system was set up to monitor total flow and motor currents independently and the problem with the pump was hidden. Had the total current divided by the flow rate for the system as a whole been monitored, the problem would certainly have caught someone's attention much earlier.



**Fig. 7.7.** Typical Specific Energy curve for a VSD driven system



## 7.5. Electric Utility Rate Schedules

Most commercial electric utility rate schedules (also called tariffs) include the following cost components

- Energy consumption (*kWh* or *kVARh*)
- Demand (*kW* or *kVA*)
- Power Factor
- Misc. Service charges, fuel cost adjustments, etc.

### 7.5.1. Energy Consumption

Energy consumption (*kWh*) on the “load” side can be calculated fairly easily as discussed above. However, depending on the electric utility, this value may be tracked and billed in many different ways on the “meter” side. Some of these billing calculations include:

- What time of day the energy was used (on peak, off peak)
- What month or season the energy was used (i.e. winter/summer)
- Different rates for each quantity (or block) of energy used during the month

In addition, these *kWh* charges may be billed multiple times in different categories and for those areas where electric utilities have been deregulated, may also be itemized on a separate energy supply bill and an energy delivery bill.

### 7.5.2. Demand Charges

Demand charges are billed by the electric utilities to recover costs for providing distribution and transmission capacity to meet a facility’s peak electrical load. The monthly demand charges on an electric bill are based on the peak energy use (usually in *kW*) recorded during the month. The electric meter that measures this value records the highest average *kW* value in a 15 or 30-minute period. Based on this measurement interval, it can be seen that a short surge in energy use (such as when a motor is started) will have a minimal effect on the demand recorded. An example of a typical facility demand profile is shown in Figure 7.8

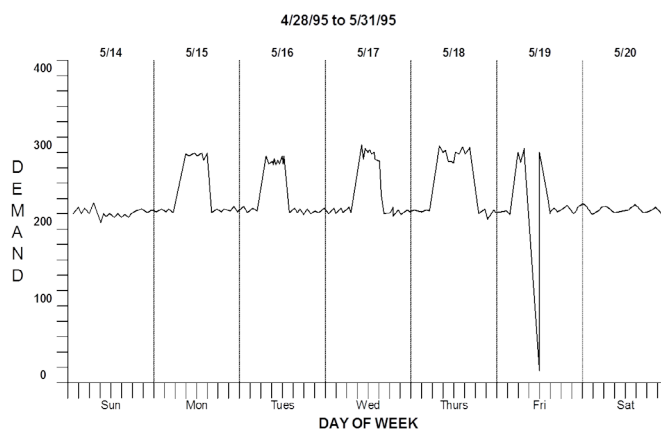


Fig. 7.8. Sample Demand Chart



The chart, in Figure 7.8, shows a steady demand just over 200 kW all day Sunday and Monday morning. However when additional equipment is operated during the day shift, the demand reaches close to 300 kW. This is the value that the utility will charge for the monthly peak demand.

When the value is read by the utility every month, it is reset back to zero to record the peak value for the next month. Demand charges can range from 3.00 USD/Euro per kW up to 25.00 USD/Euro per kW, depending on the utility and the rate schedule.

It is also worth noting that a portion of a peak demand value recorded in one month may also be carried forward for up to 11 months, even though the monthly demand has dropped to a lower level. This is typically shown as the “billed demand” versus the actual monthly demand, which is usually labeled as the “recorded demand”.

For some pump stations, demand can be a significant cost component of an electric bill. An example of this is shown below:

A pump station with a 100 kW pump operates 100 hours during the month

- Demand would be 100 kW (assuming that the pump operated continuously for longer than the 15 or 30 minute demand period)
- Consumption would be 100 kW \* 100 hours or 10 000 kWh for the month

Using a typical demand charge of 8.00 USD/Euro per kW and a energy consumption cost of 0.10 USD/Euro per kWh:

$$100 \text{ kW} * 8.00/\text{kW} = 800 \text{ USD/Euro per month}$$
$$10\,000 \text{ kWh} * 0.10/\text{kWh} = 1000 \text{ USD/Euro per month}$$

Monthly consumption and demand charges are 1800 USD/Euro

For this simplified example, annual pump station electric cost is 21 600 USD/Euro with demand representing 44% of the total bill!

The above example shows that the impact of demand charges that must be accounted for to maximize energy cost savings when pump systems are optimized.

### 7.5.3. Power Factor

Power factor is the ratio of working power to apparent power. Power factor measures how effective electricity is being used by a facility. A facility that has a substantial amount of inductive motor loads may have a poor power factor compared to a facility that has mostly resistive loads (such as electric heaters). Utilities may penalize facilities with low power factors (typically less than 80%), and may reward facilities with high power factors.



The good news is that power factor can be improved by installing power factor correction capacitors. The economics of installing this equipment must be reviewed to evaluate project cost effectiveness.

#### 7.5.4. Contacting the Electric Utility

The important thing to realize is that energy bills can be very complicated and that one of the most important steps when performing energy cost saving calculations is to contact your electric utility account representative and review the electric rate schedule together to make sure you understand how your being billed.

### 7.6. Key Learning Points

Key learning points for this chapter includes:

- The electric power equations can be used to determine pump system energy use anywhere on the pump curve and that all system components that effect efficiency must be included.
- Electric utility rate schedules typically include a kWh charge and demand charge, but may also include power factor charges and other fees.
- The cost for kWh may vary with the time of day, quantity use, or the time of year. kWh charges may also have many different components and be listed on a supply and distribution bill.
- Demand charges are based on the highest kW value recorded in a 15 or 30-minute period during the month and can be a substantial portion of the monthly electric bill.
- The best way to understand your electric bill is to review it with your utility account representative.



## 8. MOTORS

### 8.1. General

Electrical motors are the prime drivers for pumps. There are many types of electrical motors available. However, the caged rotor, asynchronous, AC induction motor is by far the most common type. This motor is simple, rugged, reliable and inexpensive. The latest designs of Premium motors are generally very efficient and the motors can easily be controlled by a variable frequency drive (VFD). All of this makes them ideal prime drivers for pumps.

The cost of permanent magnets is steadily decreasing, as the quality gets higher. As permanent magnet (PM) motors offer even higher efficiencies, it is reasonable to assume that the use of PM motors will increase.


There are many older types of motors that can also be operated at different speeds, i.e. the DC motors and wound rotor motors, but the electronic variable speed drives driving AC motors dominate the market today. The following will therefore deal only with this type of motor.

Motors are dealt with more thoroughly in *Motor System Module* of the *Industrial Systems Optimization Program*.

### 8.2. Asynchronous Induction Motors

As stated above, asynchronous induction motors are the most common motor type. Of these over 90% are of the rotor cage or “squirrel cage” execution. The name comes from the design of the rotor that has conductors of aluminum or copper that resembles a squirrel cage. There are both single and three phase motors available of this type. For industrial use, three phase

Fig. 8.1. Typical motor nameplate

<Name of Manufacturer>					
ORD. No.	1N4560981324				
TYPE	HIGH EFFICIENCY	FRAME	286T		
H.P.	42	SERVICE FACTOR	1.10	3 PH	
AMPS	42	VOLTS	415	Y	
R.P.M.	1790	HERTZ	60	4 POLE	
DUTY	CONT		DATE	01/15/2003	
CLASS INSUL	F	NEMA DESIGN	B	NEMA NOM. EFF.	95
<Address of Manufacturer> 					



motors are commonly used. The most common motor enclosures are open drip proof motors (ODP) that are used in clean, non-hazardous areas, totally enclosed fan cooled (TEFC) motors which are typically used in non-hazardous, industrial areas where dirt or moisture be present, and hazardous location motors which are designed to be used in hazardous environments as defined by the National Electrical Code (NEC) classifications. General information about the motor can be found on the motor nameplate as shown in Figure 8.1.

### 8.2.1. Starting Characteristics

When connected to the full line voltage, an induction motors draw a very high current known as the “Locked Rotor Current.” They also produce torque, which is known as the “Locked Rotor Torque”. The Locked Rotor Torque (LRT) and the Locked Rotor Current (LRC) are a function of the terminal voltage of the motor and the motor design. As the motor accelerates, both the torque and the current will change with rotor speed if the voltage is maintained constantly. The starting current will drop slowly as the motor accelerates and will only begin to fall significantly when the motor has reached at least 80% of the full speed. Figure 8.2 shows the typical starting characteristics for a direct on line start of an induction motor. The actual curves can vary considerably between designs but the general trend is for a high current until the motor has almost reached full speed. The Locked Rotor Current (LRC) of a motor can range from 500% of Full-Load Current (FLC) to as high as 1400% of FLC. Typically, good motors fall in the range of 550% to 750% of FLC.

It is important to know the starting current of a motor in order to properly size the other electrical components.

The starting torque of an induction motor starting with a fixed voltage will drop a little to the minimum torque, known as the pull-up torque, as the motor accelerates and then rises to a maximum torque, known as the breakdown or pull-out torque, at almost full speed and then drop to zero at the synchronous speed.

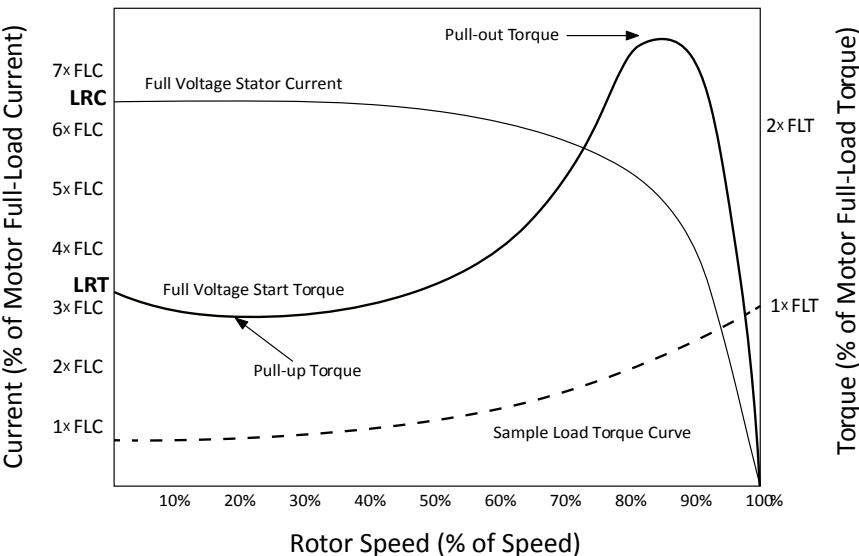


Fig. 8.2. Typical torque-speed curve for a 3-phase AC induction motor

The curve of the start torque against the rotor speed is dependant on the terminal voltage and the rotor design. The Locked Rotor Torque (LRT) of an induction motor can vary from as low as 60% of FLT to as high as 350% of FLT. The pull-up torque can be as low as 40% of FLT and the breakdown torque can be as high as 350% of FLT. Typically, LRTs for medium to large motors are in the order of 120% of FLT to 280% of FLT. For the motor to start, it is important that the available torque is larger than the torque required by the load. The motor will run at a point where the motor torque and the load torque are equal. This occurs at a speed somewhat lower than the synchronous speed. The difference is called the slip.

Motors with high efficiency tend to have lower slip and hence run faster than older motors with lower efficiency. The actual running speed is important to know since it influences the pump performance.

### 8.2.2. Running Characteristics

The synchronous speed of a motor is determined by the number of poles in the stator as defined by Equation 8.1.

$$n = 120 \times f/p$$

**Eq. 8.1.** Motor Speed

Where  $n$  = speed in  $r/min$ ,  $f$  = supply frequency (Hz), and  $p$  = number of poles

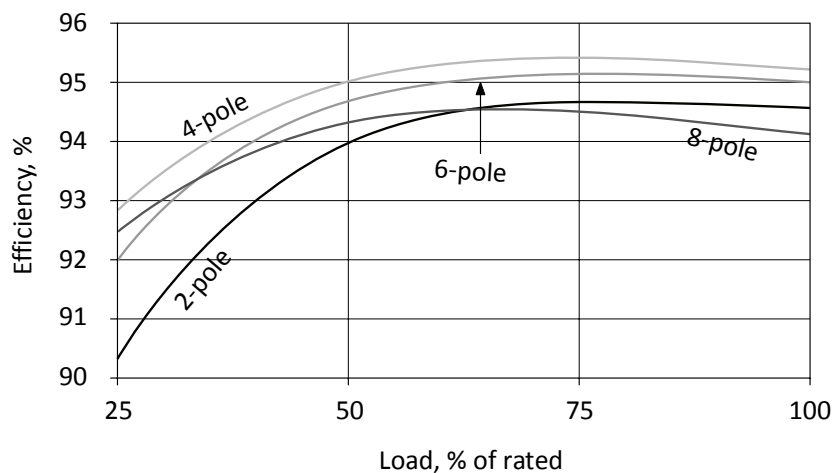
**Table 8.1.** Speeds for 60 Hz motors with different pole numbers

Nº of Poles	Synchronous speed at 50 Hz	Synchronous speed at 60 Hz
2	3000	3600
4	1500	1800
6	1000	1200
8	750	900
10	600	720
12	500	600

The actual full-load slip of a particular motor is dependant on the motor design. Typically, it is less than 3-4%.

### 8.2.3. Motor Efficiency

The majority of induction motors are designed and manufactured to meet specific design standards, which specify output power, synchronous speed and critical dimensions. The efficiency standards were set, in 1992, by the Energy Policy Act (EPAct 92) In the U.S. This standard covers most motors sold in the market place and sets minimum efficiency standards. Figure 8.3 shows typical motor efficiencies for 75 kW standard industrial motors. As can be seen in the figure, the efficiency of a modern motor is very high. In general, the efficiency is constant within 1-2% between 50 and 100% load. The maximum efficiency usually occurs around 75% load. Below 50% load the efficiency falls, but for modern motors it remains good down to about 25% load.



**Fig. 8.3.** Typical efficiencies for 60Hz, 75 kW motors

### 8.2.4. Using Adjustable Speed Drives with Motors

When a motor is connected to an ASD, it is subjected to short and high voltage pulses sent out at a very high frequency by the ASD. The voltage of these pulses is related to the line voltage and can reach levels where corona effects are created in the windings. This, in turn, can have a detrimental effect on the wire insulation and can cause burn through in the stator. This has led to the development of new types of wire insulation that are resistant to the high voltage spikes sent out by an ASD. Motors equipped with this type of higher quality wire insulation are called “inverter duty motors”. The problem with voltage spikes is more pronounced on 60 Hz grids than they are on 50 Hz grids, as the line voltages there are higher.

### 8.2.5. Service Factor

The service factor (SF) is a measure of continuous overload capacity at which a motor can operate without overload or damage. The motor manufacturer measures the heat rise in a motor as a function of load. The motor is stamped as having a certain power i.e. 75 kW depending on how high temperature-rise is that can be tolerated. The power that the motor can deliver is, however, higher than the stamped value. If the motor delivers more power than its nominal power, it will run hotter and the life of the motor will be shorter. As long as the power delivered is within the service factor, the temperature rise in the motor will still be within specifications. For motors larger than 1 kW, the standard NEMA service factor is 1.15 for open drip proof motors and 1.0 for TEFC motors.

Regardless of the nameplate service factor, any motor that is operated above a 1.0 service factor increases the risk of premature motor failure. The service factor is intended to signify the motor’s capability of operating in an overload condition for a short period of time not as a consistent mode of operation.

### 8.2.6. Temperature Rise

According to NEMA MG1 12.15-16, the winding temperature rise above the temperature of the cooling medium (ambient temperature, shall not exceed the values given in Table 8.2.

**Table 8.2.** Average Winding Temperature Rise  
(Based on maximum ambient temperature of 40° C; Temperatures given in Degrees C)

Insulation Class	A	B	F	H
Motors with 1.0 Service Factor other than those listed below	60	80	105	125
All motors with 1.15 or higher service factor	70	90	115	----
Totally enclosed non-ventilated motors with 1.0 service factor	65	85	110	130
Motors with encapsulated windings and with 1.0 service factor, all enclosures	65	85	110	----

When these temperatures are higher than recommended, motor winding insulation will deteriorate rapidly. A rule of thumb is that insulation life is reduced by 50% for every increase of 10° C of additional heat to the windings.

### 8.2.7. Maximum Number of Starts

In addition to having a properly sized motor, the entire system must be designed properly to ensure motor reliability is not comprised. When a motor is used for a pump system, one of the key parameters that must be reviewed is the number of starts and stops a motor is subjected to during normal operation. Table 8.3 provides a general guide to the number of motor starts and minimum off time per hour.

**Table 8.3.** Maximum starts/minimum off time per hour

kW	2-pole		4-pole		6-pole	
	Max Starts/hr	Minimum off time (sec)	Max Starts/hr	Minimum off time (sec)	Max Starts/hr	Minimum off time (sec)
1	15	75	30	38	34	33
5	8.1	83	16.3	42	18.4	37
10	6.2	92	12.5	46	14.2	41
15	5.4	100	10.7	46	12.1	44
20	4.8	100	9.6	55	10.9	48
50	3.4	145	6.8	72	7.7	64
75	2.9	180	5.8	90	6.6	79
100	2.6	220	5.2	110	5.9	97
200	2	600	4	300	4.8	268
250	1.8	1000	3.7	500	4.2	440

Preventing frequent motor starts and stops may require system changes such as:

- Larger tanks on pump suction and discharge to extend pump run time
- Adjustment of process parameters to extend on/off times
- Inclusion of a variable speed drive to extend run time

Ideally, system changes will also strive to optimize pump system efficiency.



### 8.2.8. Effects of Changing out Motors

It is common that motors are exchanged for new ones when they break down. When a new motor is put in service it will in all likelihood be more efficient than the old motor, as the efficiency standards have been improved. Energy efficient motors run with less slip than older, less efficient, motors. A centrifugal load will therefore run faster with a newer motor. The affinity laws have taught us that for small changes the power absorbed by the motor is roughly proportional to the cube of the speed (especially for low static head applications). A small increase in speed would therefore have large effects on the power draw. For example, a pump running 2% faster would draw 8% more power from the motor. If this extra flow and pressure is throttled, the paradox that a more efficient motor requires more power arises. In order to avoid this, other changes like impeller trimming or using a variable speed drive should be undertaken in order to make use of the higher efficiency motor.

### 8.3. Key Points

- The most common motors used in industry are three phase squirrel cage asynchronous induction motors.
- Motor information can generally be found on the motor nameplate.
- Motor speed depends on supply frequency and pole number.
- Motor efficiencies are generally high for this type of motor.
- Use inverter duty motors together with ASDs.
- The meaning of service factor.
- Efficient motors run faster.



## 9. CONTROL METHODS FOR PUMPING SYSTEMS

### 9.1. Overview

This chapter reviews some common pump system control strategies and how each control method affects the pump head curve and system curve. The benefits and potential issues of using variable speed drives are also discussed.

#### 9.1.1. Pump System Control Strategies

Most process systems served by pumps do not require the full pump capacity on a continuous basis. When full flow or pressure is not required, centrifugal pump and system requirements are commonly controlled using one of the following methods:

- On/Off control
- Throttling a pump discharge valve
- Recirculating flow
- Using a variable speed drive

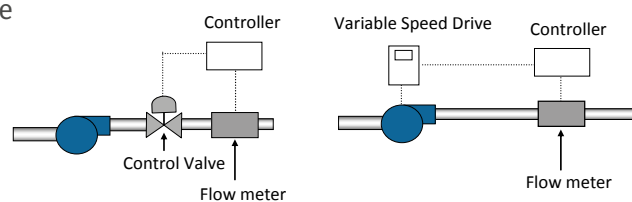
These methods are initiated by monitoring the process using instrumentation, and activating the pump, control valves or variable speed drive (vsd) to adjust pump capacity.

#### 9.1.2. Process Parameters Used For Pump Control

Some of the process parameters that are used include:

- Level controls
- Pressure indicators
- Flow meters
- Temperature probes

Fig. 9.1. Control Valve and VSD Systems





These instruments transmit an on/off signal based on set points or a varying signal. When a varied signal is provided (4-20mA is the most common), a distributed control system or loop controller is used to determine when pumps should be turned on and off, valves opened and closed or how a variable speed drive should be operated to satisfy designated process parameters. A simple illustration of a control valve and variable speed drive system controlled system that uses flow instrumentation for feedback is shown below in Figure 9.1.

## 9.2. Pump Control Strategies

### 9.2.1. On/Off Control

On/Off control is the simplest and most common way to operate small pumps. When flow is needed, a pump is activated to satisfy process needs and deactivated when the pump is no longer required. This type of control is adequate for small pump systems, but may become less practical for larger pump systems that require frequent on/off control for process needs.

### 9.2.2. Using a Control Valve to Throttle the Pump Discharge

In many industries, pump flow is routinely controlled by throttling a modulating control valves on the pump discharge. The throttled valve can be controlled to maintain a designated flow rate, pressure or any other parameter to satisfy system needs. Whether it is a single valve on the pump discharge or multiple valves throughout a system (such as golf course sprinkler system), the pump flow is decreased by increasing the resistance in the pipe system and moving the operating point up the pump head curve as shown in Figure 9.2.

As seen in the Figure 9.2, throttling increases the pressure required to move fluid through the system. The vertical lines in the figure represent the frictional losses in the valve. The throttling losses, which are proportional to the flow rate multiplied by the pressure drop in the valve, can be substantial.

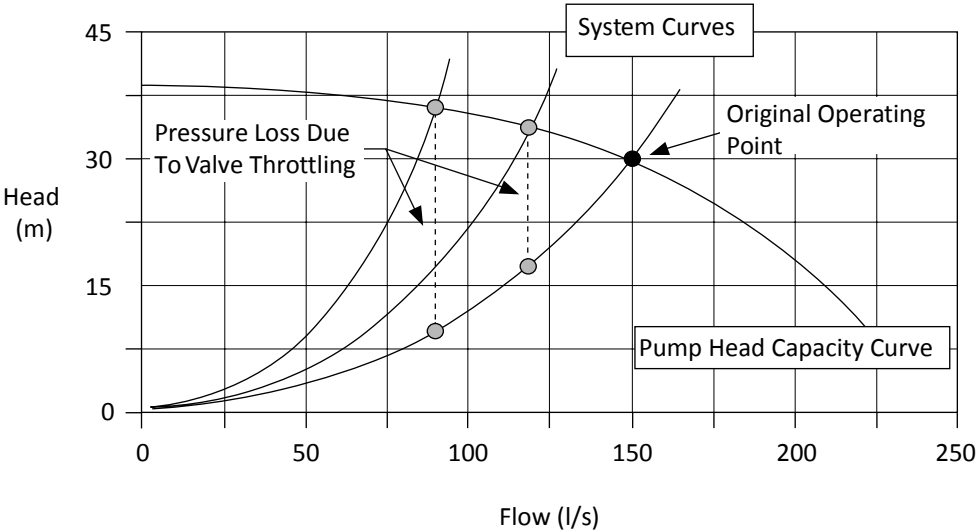
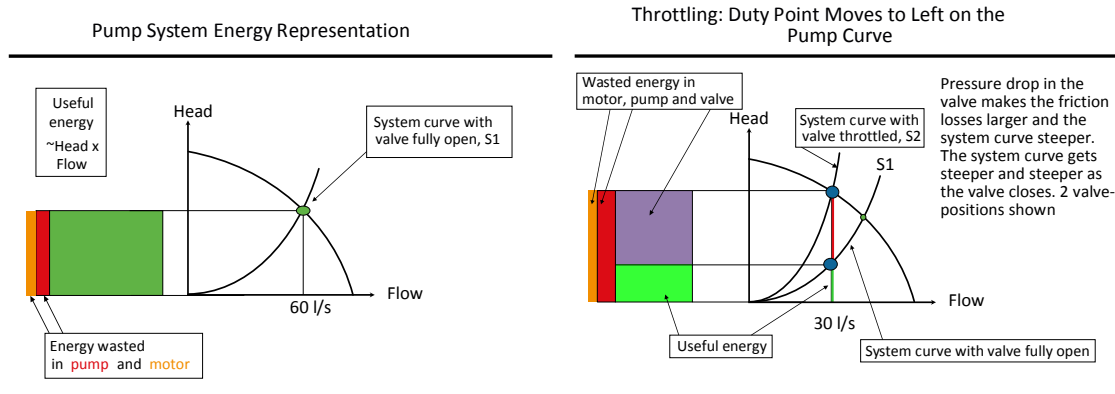


Fig. 9.2. Throttling of a centrifugal pump.

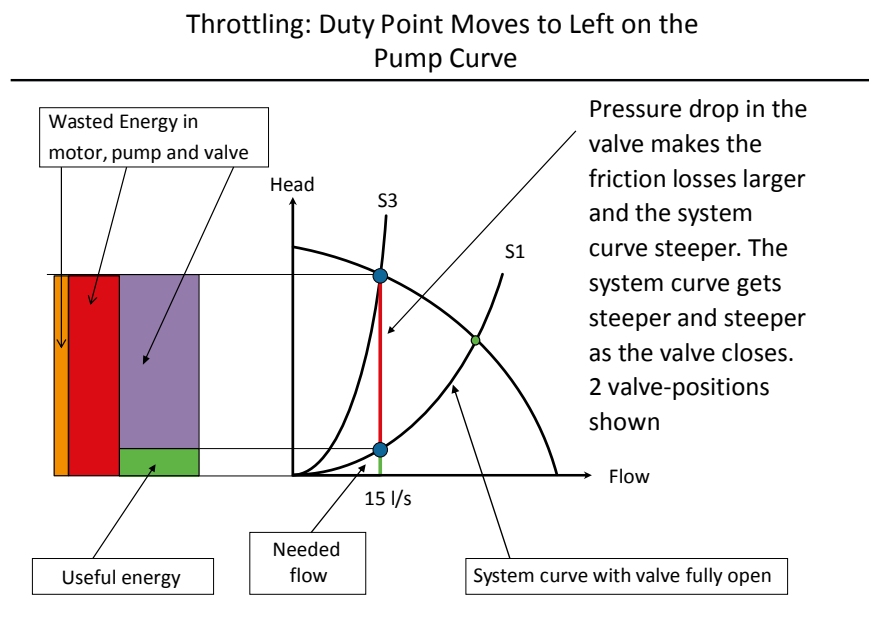
### 9.2.3. Energy representation of throttling a pump system

The energy used at different operating points in a throttled system can be graphically shown, as in the following figures:



**Fig. 9.3.** The pump operates at BEP without any throttling. The only losses are in the motor and pump.

**Fig. 9.4.** The figure shows useful energy transferred to the fluid and energy lost in motor, pump and valve. The pump losses are larger due to change in operating point.



**Fig. 9.5.** The pump is further throttled and the operation point moves to the left. The pump efficiency has fallen even more and the losses in the valve have also increased. Only a small fraction of the energy supplied to the motor is used to move fluid.



### 9.2.4. Flow Recirculation Using a Bypass System

A bypass system regulates flow by recirculating a portion of the pumped flow to the inlet side of the pump. Two control valves are typically used, as shown in Figure 9.6.

This method is used to keep large pumps activated and maintain minimum pump flow when the throttled discharge valve has reduced flow to shut-off or extremely low flow conditions.

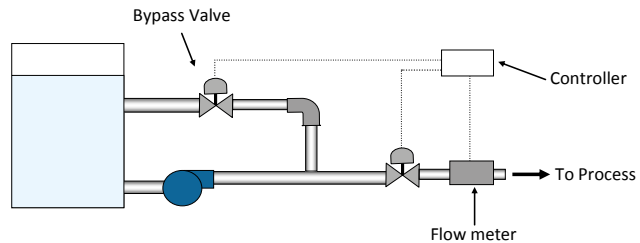


Fig. 9.6. Flow Recirculation

### 9.2.5. Using a Variable Speed Drive

Variable speed drives change the flow through the pump by changing the pump speed. This changes the *pump curve* as opposed to the *system curve* as in the case when a valve is used to regulate the flow. When using a vsd, the new duty point will fall on the system curve as shown in Figure 9.7. The shape and form of the system curve is therefore of extreme importance.

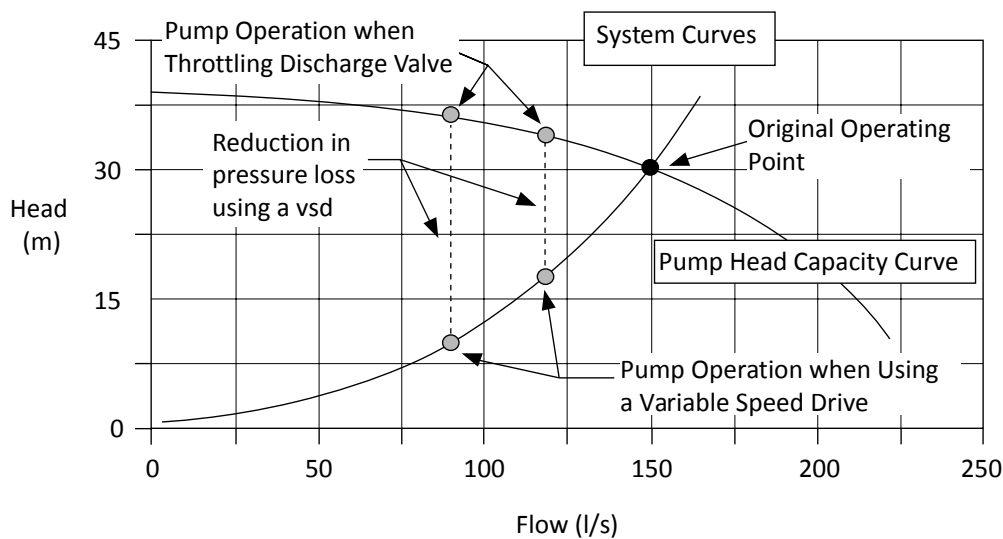
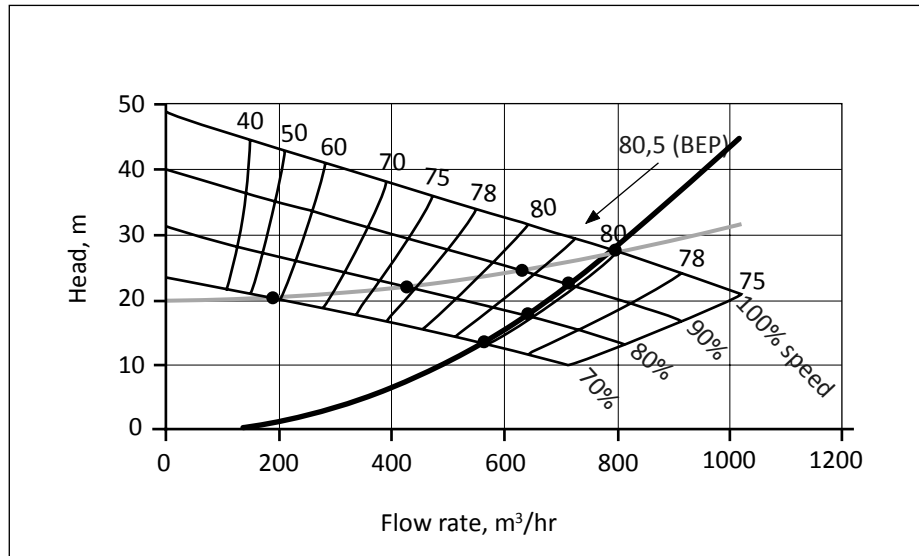


Fig. 9.7. Impact of pump speed changes with system curves

The largest pitfall when applying speed regulation is whether the system curve exhibits static head or not. Figure 9.8 shows the reduced pump curves together with efficiency lines. As can be seen in the figure, there is a large difference between the two system curves. In the case with no static head (Curve 1), the duty point follows a constant efficiency line of 80% from 100% to 70% speed. The pump efficiency is therefore constant when the speed is reduced.



**Fig. 9.8.** Impact of pump speed changes with system curves

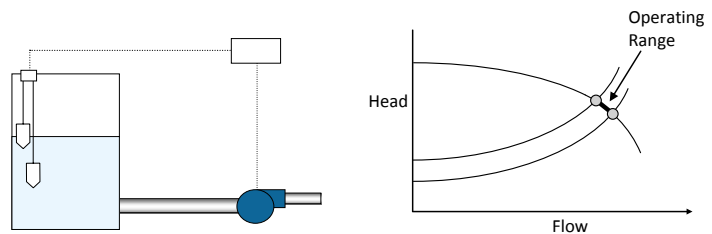
In the case of the system curve with static head (Curve 2), the situation is radically different. In this case, the system curve will move across the efficiency curves and the pump efficiency will be reduced to 60% as the pump speed is reduced from 100% to 70% speed. In cases with high static head this can result in serious problems. The operating point of the pump can move into areas where the pump should not be operated even with small changes in speed.

The pump efficiency also falls and this can cause the energy usage per pumped unit of volume to actually *increase* even if the power used by the motor decreases. It is therefore imperative that care be taken when installing variable speed drives in systems that have a fair amount of static head. Each case has to be examined individually to determine what the possible benefits could be.

## 9.3. System Requirements

### 9.3.1. Controlling by Level

A simple level control system is shown in Figure 9.9. When the water in the tank reaches the upper float the pump is activated and as the tank level is reduced, the lower float shuts the pump off.



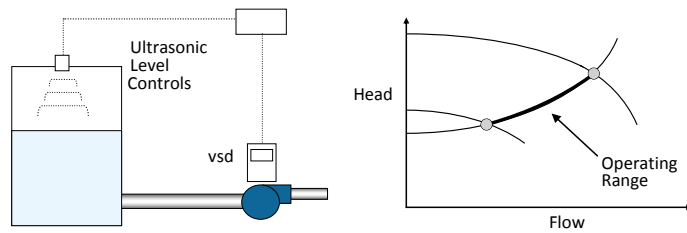
**Fig. 9.9.** On/off level control

In this arrangement, the pump operates in a narrow range on the pump curve. As the tank level goes down, the system curve moves up slightly because of the lower head on the suction side of the pump (assuming there is no level change on the pump discharge). When a vsd and a level system with proportional signal are used, the pump operating range changes as shown in Figure 9.10.



In Figure 9.10, an ultrasonic level control provides a signal to the controller where level set points are programmed. A proportional signal is then used to speed up or slow down the variable speed drive to maintain a designated level range. As shown, the pump operates between two operating points on the system curve, instead of on the full speed pump head curve for the on/off pump system operation. However, it is important to make sure that the controls do not allow the pump to operate at low speeds that may reduce pump efficiency too much or operate below the system curve.

Other proportional level control systems include pressure controls located at the bottom of the tank that measure levels through a pressure transducer, bubbler tubes that sense tank height based on the backpressure of a tube inserted in the tank, and capacitance probes.

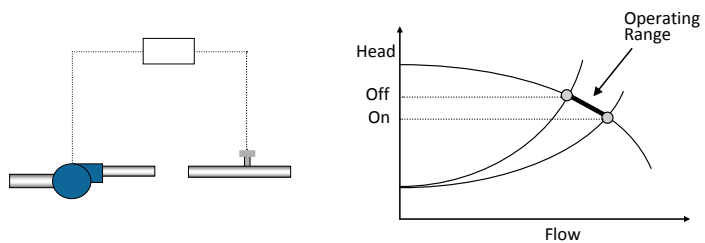


**Fig. 9.10.** Level controls using a vsd equipped pump

### 9.3.2. Controlling by Pressure

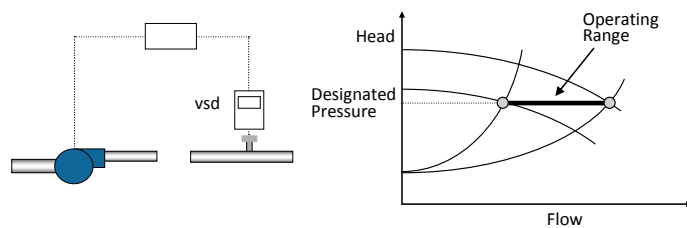
Many water systems require pumps to maintain a relatively constant pressure when flow varies due to system changes. A simple illustration of an on/off pressure control is shown in Figure 9.11. Notice that the system curve suggests that the static head has not changed since the point at zero, flow stays the same as the pump operating point moves up the head curve when pressure increases.

Figure 9.12 shows a pressure based control system equipped with a variable speed drive using a proportional pressure signal to speed up and slow down the pump to maintain a designated pressure.



**Fig. 9.11.** On/off pressure controls

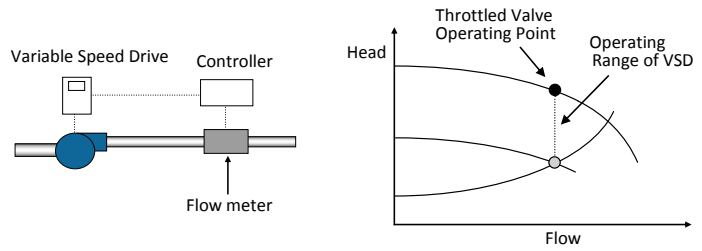
The above control system is common in water supply systems such as potable municipal water and golf course irrigation systems. As the number of users decreases (or automatic sprinkler valves shut off), the vsd reduces pump speed. Eventually, the vsd must be shut-off when the flow reaches a minimum flow set point.



**Fig. 9.12.** Pressure controls with vsd equipped pump

### 9.3.3. Flow Controls

In some cooling and washing systems, a constant flow rate is needed. For this application, a signal from a flow meter is used to adjust vsd pump speed in relation to the designated flow set point. This is shown in Figure 9.13



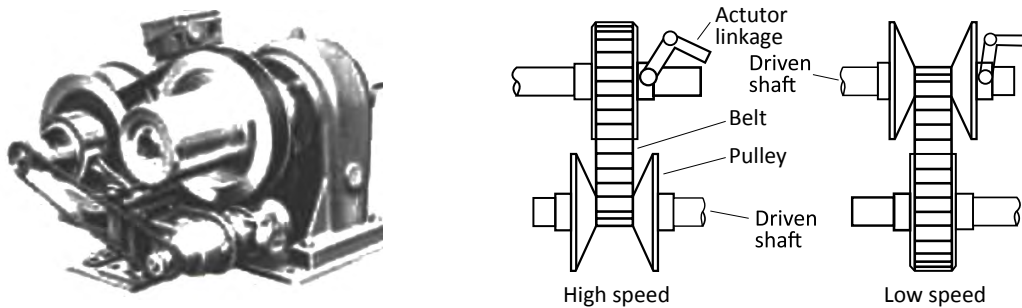
**Fig. 9.13.** Pressure controls with vsd equipped pump

If flow was controlled using a throttled discharge valve, the flow would be fixed on the pump head curve as shown.

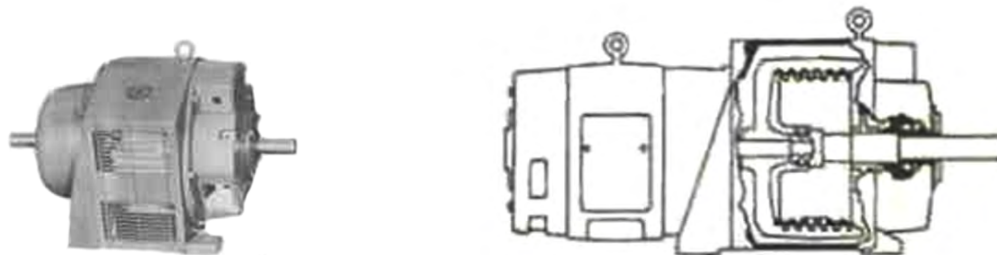
## 9.4. Understanding Variable Speed Drives

### 9.4.1. Types of Drives

The speed of an electric motor can be regulated using an electrical or mechanical type of variable speed drive. Older mechanical methods include adjustable belt drive units and eddy current magnetic clutch type drives, as shown in Figures 9.14 and 9.15.



**Fig. 9.14.** Adjustable Belt Drive



**Fig. 9.15.** Eddy current magnetic clutch drive



On the electrical side, the variable frequency drive dominates the market today. There are several different methods available that include current and voltage source inverters for asynchronous motors. Older systems that have been used in the past include wound rotor motors and eddy current magnetic clutch drives.

During the last few years the Pulse Width Modulated (PWM) drives have come to dominate the market and are used in the majority of applications. However, for some applications alternative drive types such as magnetic drives are also used.



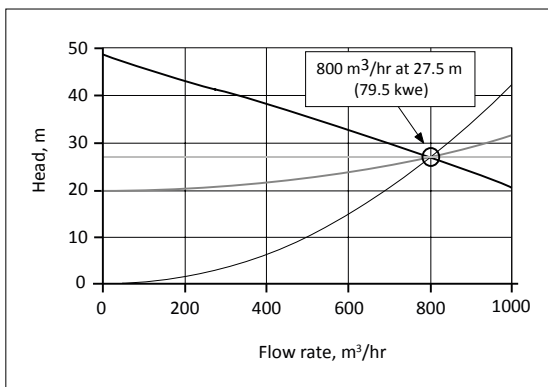
**Fig. 9.16.** PWM and magnetic variable speed drives  
*(courtesy of Robicon and MagnaDrive)*

### 9.4.2. How Speed Regulation Influences Operating Conditions

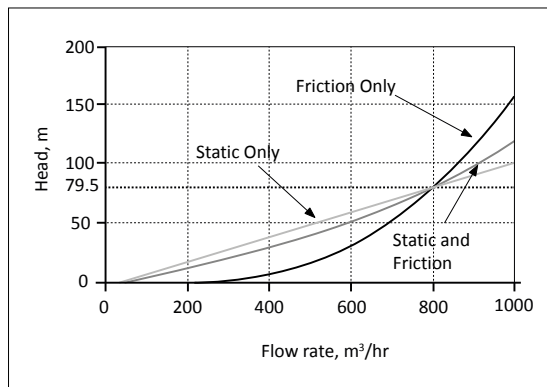
The following illustrates what happens when the pump speed is changed in a pump attached to three different systems, See Figure 9.17.

### 9.4.3. Reduced speed pump curves

The pump in Figure 9.17 is attached to the three different systems with the same full speed duty point,  $800 \text{ m}^3/\text{hr}$  @  $27.5 \text{ m}$  of head. The power drawn by the motor is  $79.5 \text{ kW}$  at this operating point as shown in Figure 9.18.



**Fig. 9.17.** The three systems used to illustrate effects of speed variation



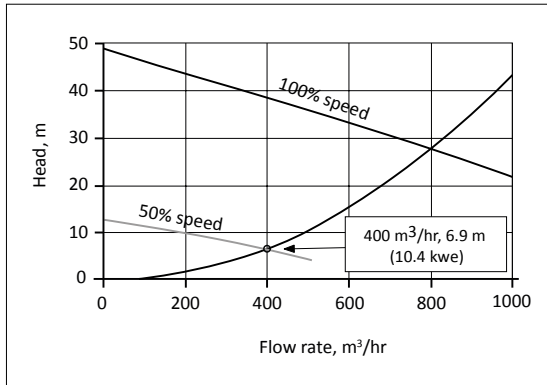
**Fig. 9.18.** Three different system curves going through the same full speed duty point at  $800 \text{ m}^3/\text{hr}$



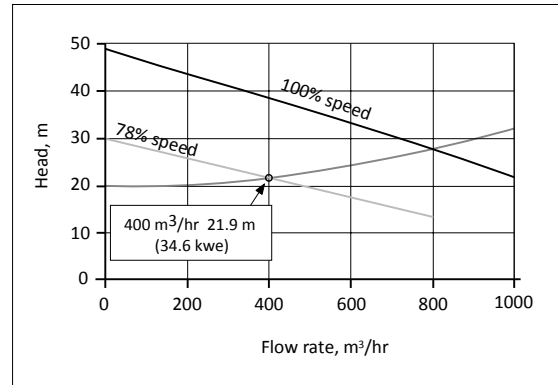
The speed is then dropped until half the flow rate is obtained in each system and speed and power draw are recorded in each case.

For the all-frictional system, the speed change does not change the pump efficiency when the speed is reduced to 50% of the original full speed. Figure 9.19.

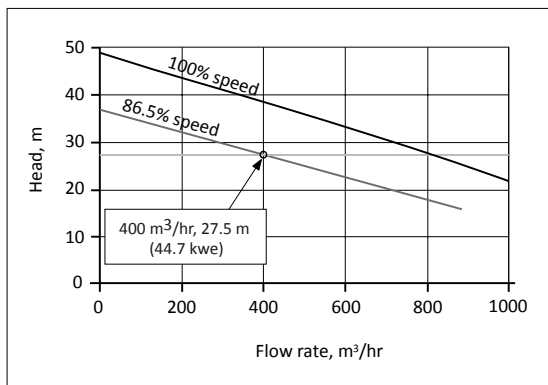
To develop 400 m<sup>3</sup>/hr in the mixed static/frictional system, the speed only has to be reduced to 78.5% of the original. The pump efficiency changes here as well. Figure 9.20.



**Fig. 9.19.** Change in speed for the all-frictional system



**Fig. 9.20.** Speed change in the mixed static/frictional system

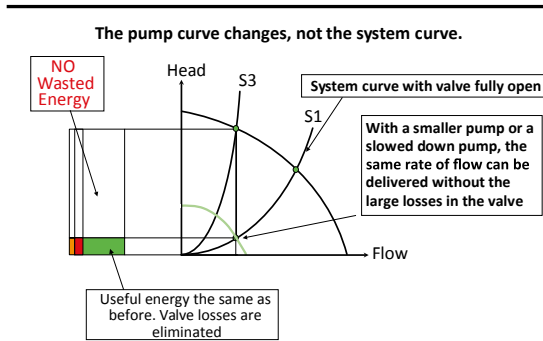


To develop 400 m<sup>3</sup>/hr in the all-static head system, the speed reduction needed to achieve 50% flow is even less, 86.5% of the original. The pump efficiency changes even more in this case. Figure 9.21.

**Fig. 9.21.** Speed change in the all-static head system

### 9.4.4. Energy representation for a Variable Speed driven pump

How a VSD saves energy



**Fig. 9.22.** This shows how the throttling losses and excessive losses in pump and motor are avoided when using a variable speed drive. It should be observed that this is the most favorable situation when there is no static head in the system.



Table 9.1 shows the change in power consumed and also the energy used per unit volume. In the case of all-static head, the energy used per unit volume of pumped liquid actually increases. In such systems the cost of pumping would therefore increase when the flow is reduced to half.

**Table 9.1.** Summary of the effect of speed regulation in three different systems

Static head (m)	m <sup>3</sup> /hr	Speed (%)	kwe	m <sup>3</sup> /kwhr	kwhr/m <sup>3</sup>
0	800	100	79.5	10.1	0.099
0	400	50.0	10.4	38.5	0.026
20	800	100	79.5	10.1	0.099
20	400	78.5	34.6	11.6	0.087
27.5	800	100	79.5	10.1	0.099
27.5	400	86.5	44.7	8.6	0.112

### 9.4.5. Static Head Considerations

It follows from the above that extra care has to be taken when installing variable speed drives in systems that have a static head. This is especially true when the static head is the dominant part of the system curve. There might be several good reasons for installing a variable speed drive in such a system, like better flow control. It should, however, be understood that the result achieved is very dependent on the type of system the drive is applied to.

Energy savings could still be obtained in systems with static head, but the savings will generally not be as large as in systems without static head.

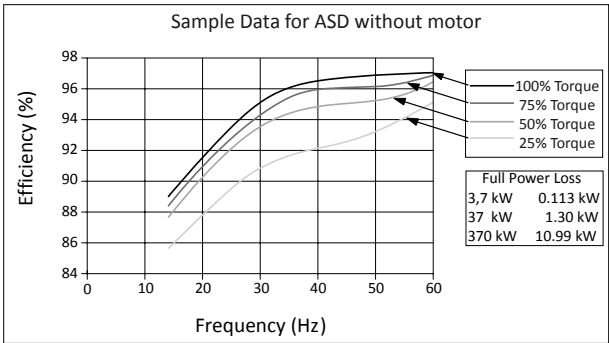
If compared to using a throttling valve, variable speed drives will always save energy but the energy consumption to pump a certain volume of liquid could increase compared to fixed speed pumping using on/off regulation.

The affinity laws can thus *not* be used for estimating energy usage in systems with static head. In order to estimate the energy usage, the actual energy use at the various operating points has to be found by combining system curve and pump curve information.

### 9.4.6. VFD Efficiency

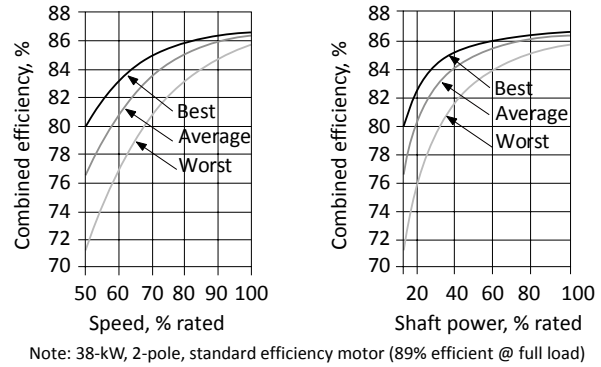
VFDs will influence the motor characteristics when they are added to a system.

There will also be losses in the VFD that are fairly constant, and hence vary as a percentage of the power delivered. Figure 9.23 shows an example of how the efficiency varies for a VSD as a function of speed and torque. For pumping applications, the torque is a second-degree function and it therefore falls off quickly when the speed is lowered.



**Fig. 9.23.** VSD efficiency as a function of speed and torque

Figure 9.24 gives an idea about the combined efficiency of drive and motor. Motors react differently to different drives. It is therefore recommended to buy the drive and motor from the same manufacturer in order to get a combination that is well matched. Modern drives have improved considerably compared to what was available some years ago.



**Fig. 9.24.** Combined motor/drive efficiency when attached to different drives

### 9.4.7. Benefits and Problems Associated with VFDs

There are many benefits that come with a variable frequency drive system such as:

- Controls speed variations
- Provides flow control
- Eliminates startup impacts causing system vibration
- Provides fault tolerance
- Supports soft starts
- Restarts spinning load
- Controls speed swings
- Enhances product quality
- Can conserve energy in some systems
- Repeats results

These benefits could be a strong reason to install a variable speed drive system even without the benefits of energy savings. There are, however, also some problems that are commonly associated with VSDs. These problems all have solutions, but the engineer/user must be aware of them in order to avoid unpleasant surprises. Typical problems include:

- Harmonic currents
- Motor terminal standing wave & ASD PWM waveform
- Crosstalk between circuits
- Bearing currents
- Mechanical vibrations
- Increased noise (acoustical)
- Static head considerations

For a detailed description of benefits and concerns, the reader is recommended to read HI and Europump’s Book: “Variable Speed Pumping, A Guide to Successful Applications.”



## 9.5. Key Learning Points

Key learning points for this chapter includes:

- The difference between various control methods
- Effects of speed regulation in different types of systems
- VFD efficiencies
- Benefits and concerns of using VFDs

### Exercise:

A vfd is retrofitted onto a pumping system that was previously controlled by a 300mm globe valve. The continuously operated circulating water pump provides a flow rate of 200 l/s 40% of the time and 150 l/s for the remainder.

1. Based on the values provided in Table 9.2, what are the annual energy savings given that the globe valve is replaced with a 300 mm butterfly valve ( $K = 0.35$  fully open)? Assume an electrical energy cost of 0.05 USD or Euro/kWh.
2. Discuss any unrealistic assumptions (see table footnotes) that have been made in this example.

**Table 9.2.** Pressure Drop and Energy Loss versus Flow Rate for a Fully-Open 300mm Valve

Flow Rate, l/s	250	200	150	100	50
Flow Velocity <sup>1</sup> , m/sec	3.54	2.83	2.12	1.42	0.71
Head Loss, m					
Globe Valve, $K=10$	6.38	4.08	2.29	1.03	0.26
Butterfly Valve, $K=0.35$	0.22	0.14	0.08	0.04	0.01
Head Loss Reduction <sup>2</sup> , m	6.16	3.94	2.21	0.99	0.25
Fluid kW Reduction	15.1	7.73	3.25	0.97	0.12
Power Savings <sup>3</sup> , kW	21.6	11.04	4.64	1.39	0.18

<sup>1</sup>Assumes a 300mm diameter pipe.

<sup>2</sup>Loss reduction due to replacing the 300mm globe valve with a fully open 300 mm butterfly valve.

<sup>3</sup>Assumes a 70% pumping plant efficiency (including the vfd).

### Answer:

$$\text{Energy Savings} = (0.4 \times 8,760 \times 11.04 \text{ kW}) + (0.6 \times 8,760 \times 4.64 \text{ kW}) = 53,317 \text{ kWh/year}$$

$$\text{Cost Savings} = 53,317 \text{ kWh/year} \times 0.05/\text{kWh} = 2,665$$

It is unrealistic to assume constant pump system efficiency as the speed of the vsd is reduced.

# 10. PSAT PROGRAMME INTRODUCTION

## 10.1. Overview of PSAT Programme

The Pumping System Assessment Tool (PSAT) is a software programme developed for the U.S. Department of Energy’s (DOE) Office of Industrial Technologies (OIT). The program was developed to assist engineers and facility operators to evaluate the efficiency of their facility pumping systems based on pump and motor nameplate data and three field measurements. A screen capture of PSAT 2008 is shown in Figure 10.1.

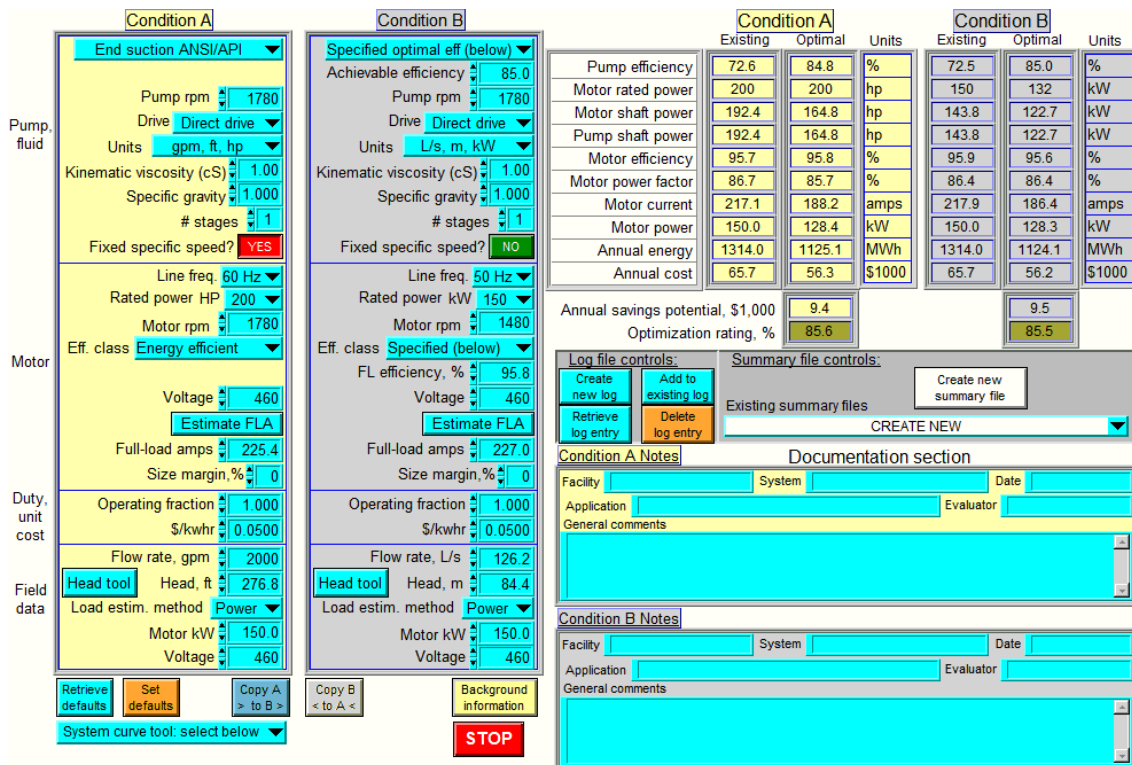


Fig. 10.1. PSAT Main Screen



For many industrial facilities, the energy consumed in pumping fluids comprises a large fraction of the total energy consumption of the facility. Operators are often not aware of how effectively energy is consumed in pumping systems. The PSAT tool provides a relatively simple and fast means of determining system efficiency and potential alternatives.

PSAT identifies energy saving opportunities in pumping systems and quantifies those opportunities in both dollars and electrical energy savings. Although PSAT does not tell how to improve systems, it does prioritize attractive opportunities and supports broader or narrower searches for improving pump efficiency.

## 10.2. PSAT Features

PSAT assesses current pump system efficiency by comparing field measurements of the power delivered to the motor with the fluid work (flow and head) required by the application. It estimates a system's achievable efficiency based on pump efficiencies (from Hydraulic Institute standards) and performance characteristics of pumps and motors (based on the MotorMaster+ database).

PSAT is best used to determine the following:

- Establish system efficiency
- Quantify potential energy savings
- Examine the impacts of different operating scenarios
- Provide data for trending system performance
- Clarify impacts of operational changes on demand charges
- Identify degraded or poorly performing pumps

Subsequent comparison of the actual and achievable efficiencies distinguishes systems with lower levels of opportunity from those that warrant additional engineering analysis.

## 10.3. PSAT Success Stories

Some examples of savings that have been discovered using the PSAT programme include:

### Mining Operation

At a gold mine, the PSAT prescreening filter (provided in Appendix A) identified three pumping systems for further analysis. Over 170 000 USD/Euro per year (2 398 200 kWh) in potential savings was identified.

### Paper Mill

Prescreening at a paper mill identified one system that presented a significant energy savings opportunity. The 64 000 USD/Euro (2252 Mwh) in annual savings was traced to inefficient operating practices rather than pump degradation.

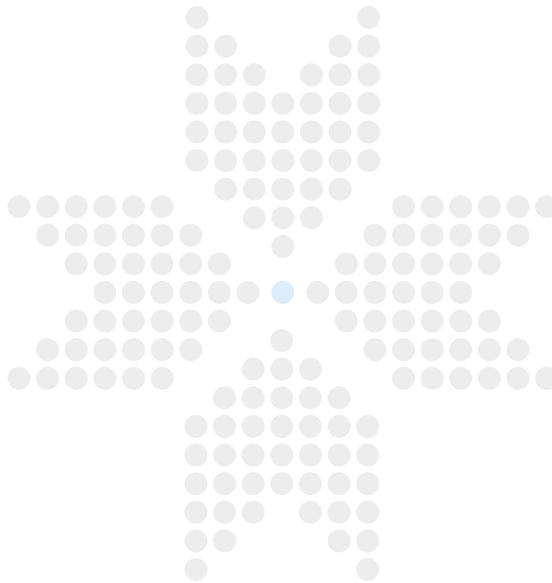
## Aluminum

An aluminum rolling mill applied PSAT to four related systems and identified over 38 000 USD/Euro per year (1 015 000 kWh) in potential savings. An aluminum plant in Pennsylvania identified savings for three systems resulting in 110 000 USD/Euro in annual savings.

## Steel Mill

A steel mill used PSAT to examine its hood spray application that used bypass controls. The mill discovered an opportunity to save 41 700 USD/Euro per year and use 13% less energy. The bypass flow control set-up was replaced with a properly sized pump and energy efficient motor that operated only when needed.

A comprehensive PSAT user manual has been included in Appendix A. The PSAT programme is available (free of charge) for download at the Department of Energy's Best Practices Programme site: <http://www.oit.doe.gov/bestpractices>



# 11. ASME PUMP STANDARD INTRODUCTION

## 11.1. Overview of the ASME Pump Standard

The ASME Pump System Assessment Standard Documentation includes the Standard as well as Guidance Document. A summary of the two documents is provided below.

### Difference Between ASME Pump Standard & Guidance Document

#### Standard EA-2-2009

- Provides a common understanding of what should be included in a pump system assessment to replace the lack of a standardization for pumps systems previously evaluated as part of an energy evaluation, audit, survey or energy study.
- Defines specific requirements that must be performed for different assessment levels.

#### Guidance Document EA-2G-2010

- Provides technical background and application details to help the user apply the standard.
- Includes rational for the technical requirements, application notes, alternative approaches, tips, techniques and examples.

### 11.1.1. The objectives of the standard include:

- Provide a step-by-step approach to perform an energy assessment of a pump system.
- Identify energy assessment levels and the effort required for each type of assessment.
- Emphasize the importance of taking a systems approach.
- Review equipment data that should be collected for pump system evaluations.
- Become familiar with solutions for pump system optimization.
- Present the results in a suitable format.



The standard is organized into the following sections:

1. Scope & Introduction
2. Definitions
3. References
4. Organizing the Assessment
5. Conducting the Assessment
6. Analyzing the Data
7. Reporting & Documentation

For this review we will focus on Sections 4 and 5.

### **11.1.2. Section 4 of the ASME Standard**

Section 4 of the standard looks at organizing the assessment. Specific areas include:

#### **4.1 Identification and Responsibilities of Assessment Team Members**

- Authorized Manager - accepts overall responsibility for funding and decision making (may not be present during assessment).
- Assessment Team Leader - familiar with operations and maintenance of pump systems to be reviewed and able to organize resources to evaluate pumps.
- Pump System Expert - qualified to perform the assessment activities, data analysis and report preparation.

#### **4.2 Facility Management Support**

Facility management should provide written support, to commit the resources needed. Develop a written agreement/purchase order before arriving on site that *clearly defines Goals and Scope of Assessment*.

#### **4.4 Access to Resources and Information**

- Review access to equipment areas.
- Discuss needed personnel to conduct assessment (electrician, engineers, operations staff).
- Determine access to data such as drawings, manuals, utility bill data, computer monitoring and control data.

#### **4.5 Assessment Goals & Scope**

Overall goals and assessment scope should be reviewed (This was defined before arriving on site – but should be reviewed with all meeting attendees)

#### **4.6 Initial Data Collection and Evaluation**

Before Arriving on Site: Work with facility to identify pump systems that will be reviewed. A sample-prescreening template is shown below.



Pump System Screening Questions					
System Name/ID	Paper Machines 411 and 412				
	Pump ID				
	Pump #401	Pump #605	Pump #333	Pump #210	Pump #422
Estimated annual operating hours	7600	7600	7600	7600	7600
Motor rated <i>hp</i>	75	125	150	100	150
Is system throttle valve-controlled?	yes	yes	yes	yes	yes
Is the pump bypassing to regulate flow/pressure?	no	no	no	no	no
Multiple parallel pumps with same # normally operating?	yes	yes	yes	yes	yes
Distributed cooling system with multiple unregulated loads?	no	no	no	no	no
Constant pump operation in batch process?	constant	constant	constant	constant	constant
Frequent cycle batch operation in continuous process?	no	no	no	no	no
Cavitation noise at pump or elsewhere in system?	no	no	no	no	no
High system maintenance without obvious causes?	no	no	no	no	yes
Has system function or demand changed over time with no pump change?	no	no	no	no	no
Is flow metered?	yes	yes	yes	yes	yes

Obtain energy use and cost data to determine unit costs

Current Year		2010					
Month	Monthly Site Electricity Consumption (MWH)	Total Monthly Electricity Cost (\$)	Monthly Natural Gas Consumption (MMBtu)	Total Monthly Natural Gas Cost (\$)	Monthly Steam Consumption (MMBtu)	Total Monthly Steam Cost (\$)	Monthly Heavy Fuel Oil Consumption (MMBtu)
January	6.57	\$445,924	17,448	\$120,466	78,698	\$451,885	
February	6.39	\$456,088	16,635	\$147,556	72,787	\$447,478	
March	6.86	\$466,007	17,809	\$123,209	73,095	\$437,502	
April	5.65	\$459,013	14,379	\$143,309	49,906	\$373,967	
May	7.41	\$513,624	19,652	\$121,629	54,454	\$375,194	
June	7.88	\$545,731	20,353	\$161,600	53,877	\$379,361	
July	7.32	\$527,183	16,738	\$143,719	52,889	\$379,405	
August	7.49	\$530,737	19,189		50,424	\$364,642	
September							
October							
November							
December							
<b>Grand Total</b>	<b>55.58</b>	<b>\$3,944,308</b>	<b>142,201.80</b>	<b>\$961,488</b>	<b>486,129</b>	<b>\$3,209,434</b>	<b>0</b>

Upon arriving at the facility, system data can be collected. The details of this process are summarized in the following standard sections:

#### 4.6.4 Systems Data

- Define the system (s) functions and boundaries
- Identify high energy use equipment
- Identify control methods
- Identify inefficient devices
- Initial measurement of key operating parameters

#### 4.7 Site Specific Goals

Based on preliminary data collection – develop a measurement plan that takes into account the three evaluation levels (to be discussed) and goals that are consistent with scope of work.

#### 4.8 Develop a plan of action & schedule activities

- Review information that has been collected
- Prioritize pump systems that will be reviewed in more detail (assessment levels to be discussed)
- Identify control methods
- Identify inefficient devices
- Initial measurement of key operating parameters
- Define schedule for activities (staff interviews, electrician time, meetings)

### 11.1.3. Section 5 of the ASME Standard

Section 5 of the standard reviews strategies for conducting the assessment. Specific areas include:

- 5.2 Assessment Levels.
- 5.3 Walk Through.
- 5.4 Understanding System Requirements.
- 5.5 Determining System Boundaries and System Demand.
- 5.6 Information Needed to Assess the Efficiency of a Pump System.
- 5.7 Data Collection Methodology.
- 5.8 Cross Validation.
- 5.9 Wrap-up Meeting and Presentation of Initial Findings and Recommendations.

The assessment levels are summarized below:

#### **Level #1**

Prescreening and gathering preliminary data(qualitative effort) to identify potential energy savings potential.

#### **Level #2**

Measurement based quantitative evaluation to determine energysavings. This assessment is based on “snapshot” measurements that cover a limited amount of time.

#### **Level #3**

This requires more extensive *quantitative* data collection effort to develop a system load profile because it is for systems where conditions vary over time.



Activities	Level 1 Assessment	Level 2 Assessment	Level 3 Assessment
Prescreening	Req.	n/a	n/a
Walk through	Opt.	Req.	Req.
Identify systems with potential saving opportunities	Req.	Req.	Req.
Evaluate systems with potential saving opportunities	Opt.	Req.	Req.
Snapshot type measurement of flow, head and power data	Opt.	Req.	n/a
Measurement/data logging of systems with flow conditions that vary over time	n/a	n/a	Req.

We recommend obtaining a copy of the Standard & Guidance Document for a more detailed review of the assessment process.



## **12. FIELD ASSESSMENT AND DATA COLLECTION**

---

### **12.1. Preparation**

In this Chapter it's time to “roll up your sleeves” and head out into the facility to begin collecting field data.

However, before rushing out to take data for every pump system in the plant, an important part of identifying energy saving opportunities is to take the time to understand the facilities pump systems thoroughly before starting to collect field data. This process includes sitting down with an operator or mechanic (both is preferable) to discuss all major pump systems at the facility. As discussed in the Prescreening section of Chapter 1, some of the questions that should be asked include:

- What are the largest pump systems at the facility
- What are they used for? What are the system requirements?
- How many hours does each pump operate annually? Are pumps operated in parallel?
- When the pumps are operated, is flow or head reduced during certain times of the day? How many hours do they operate at these conditions?
- Are discharge valves or adjustable speed drives used to control flow?
- Do any of the pumps require high maintenance?

As part of this effort, it is important to focus first on the largest pump systems that operate the most hours and then to move on to smaller pumps as time permits.

### **12.2. Data Collection Before Field Assessment**

Hopefully after your initial discussions, several high energy use pump systems have been identified as potential evaluation candidates. However, before grabbing your test equipment and heading out to the plant, this is the best time to collect two other pieces of information that will help make the data collection process more productive.



The first item is a P&ID (process and instrumentation diagram) or a piping schematic of the pump system. Ideally these drawings would also have elevations of the pump and the suction and discharge points. This information will be useful later during the analysis stage. As the operator traces out the flow, additional information can be collected about the system and what kind of data collection will be required to determine what the system needs versus what the pump may be providing.

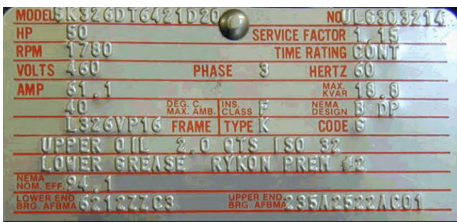
The second item that should be requested at this time is a copy of the pump curve, any field-testing data taken when the pump was installed (or if pump tests have been performed over the years) and specific component information (pump and motor specification sheets).

Having the above information will make your field-testing much more productive by developing a data collection strategy that may be focused more on system measurements versus taking data at the pump only.

### 12.3. Collecting Field Data

#### 12.3.1. Nameplate Data

Hopefully at this point, you have collected information about the motor and pump from the manufacturer’s O&M manual or most likely from the submittal that the contractor provided to the facility to get approval before purchasing the pump.



The next step is to verify this information and obtain additional data from the pump and motor nameplates as shown in Figure 12.1.

The most useful nameplate data includes motor hp, rpms, volts, amps and efficiency rating for the motor, and flow, total head, stages and impeller trim for the pump. A pocketknife, rag and flashlight may be needed to uncover this information below several layers of paint or grease.



Fig. 12.1. Motor and Pump Nameplate Data

#### 12.3.2. Test Equipment

On rare occasions, getting data may be as simple as recording information from existing flow, pressure and power instrumentation (all permanently installed and recently calibrated). However, in most cases it will be necessary to invest in portable instrumentation and some simple tools as noted below in Table 12.1.

**Table 12.1.** Recommended Equipment

Equipment	Estimated Cost (USD/Euro)
Ultrasonic flow meter & accessories	5000 to 7000
Power meter w/various probes	1000 to 2000
Portable pressure instrumentation w/various NPT adaptors	300 to 500
Strobe tachometer	300
Flashlight, rag, sandpaper, wrenches, screwdrivers	< 100
Extension cord, pocket knife, notepad	< 100
Digital camera, extra batteries for all equipment	500
Rubber gloves, safety glasses, hardhat	< 100
Data loggers, various CTs	500 to 700
Laptop (to program data loggers)	1500

## 12.4. Fundamentals Review

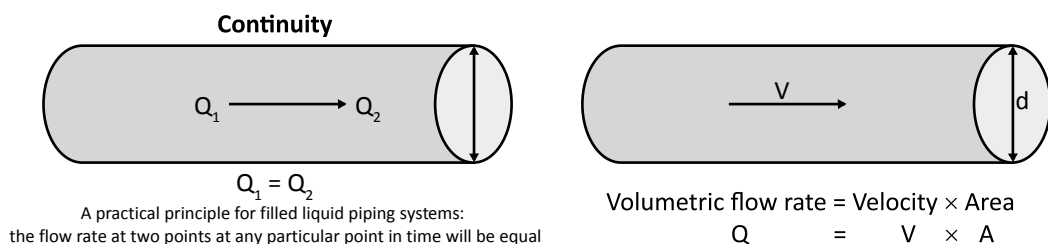
The parameters needed for assessing the efficiency of a pumping system are:

- Flow rate
- Pressure
- Elevation
- Electric power
- Fluid Properties

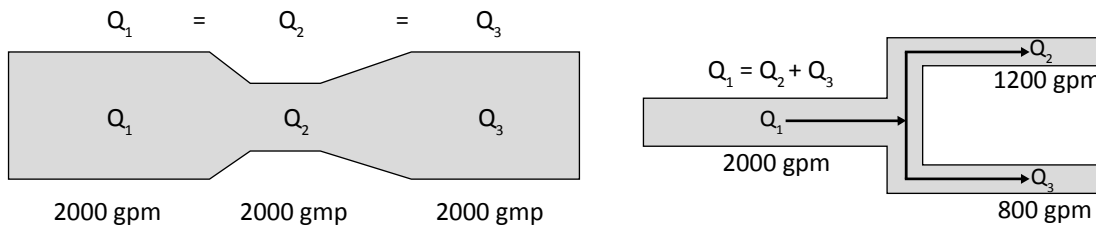
The Bernoulli equation is the basic law governing fluid flow. It is an energy conservation law. However, we will get back to the Bernoulli law later as first we will start with some other basic relationships that are valid for incompressible flow.

### 12.4.1. The Law of Continuity

In a closed pipe the flow rate will be the same at all points. If the pipe branches the sum of the branch flow rates will be equal to the original flow rate. The flow rate equals average velocity multiplied with the cross sectional area.



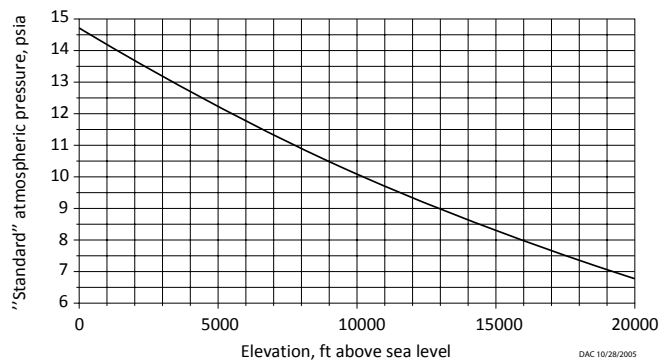
**Fig. 12.2.** Continuity [ $A = \pi \times d^2/2^2$ ]



**Fig. 12.3.** Law of Continuity

### 12.4.2. Pressure and Elevation Basics

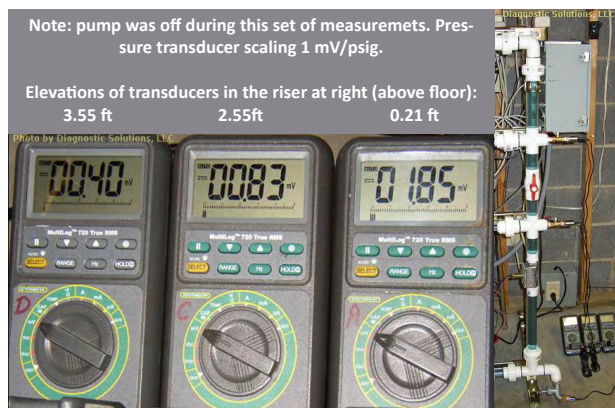
Pressure in a vessel is usually measured in kilo Pascal, kPa. It is measured relative atmospheric pressure or as an absolute pressure independent of atmospheric pressure. The atmospheric pressure varies with time and height relative to the sea level (as shown in Figure 12.4).



**Fig. 12.4.** Atmospheric Pressure as a Function of Elevation

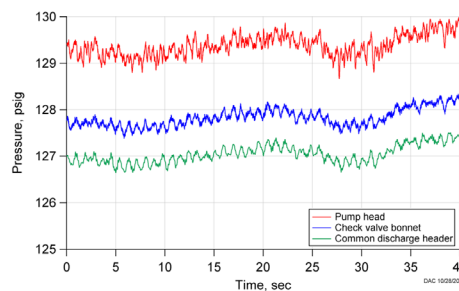
The pressure in a vessel filled with liquid varies in the same way. This is why we always need to know at which height pressure is measured.

The pressure at a given height in the vessel will be the same, but it varies with height. Therefore, it is important to know at what height the measurement is taken. This is demonstrated in Figure 12.5.



**Fig. 12.5.** Pressure Based on Height

Furthermore, the pressure measured in the system will be lower as you move downstream with the fluid due to friction, which consumes energy. This manifests itself as a loss of pressure. Variations in pressure along a pipe are similar (figure 12.6)



**Fig. 12.6.** Gauge Pressure Varies with Location and Time





### 12.4.3. The Bernoulli equation

Bernoulli’s law is a conservation of energy law. As long as there is no friction the total energy content in the fluid will be the same at point 1 and 2 in Figure 12.7. As seen, there are 3 different energy components kinetic energy, pressure and potential energy (elevation).

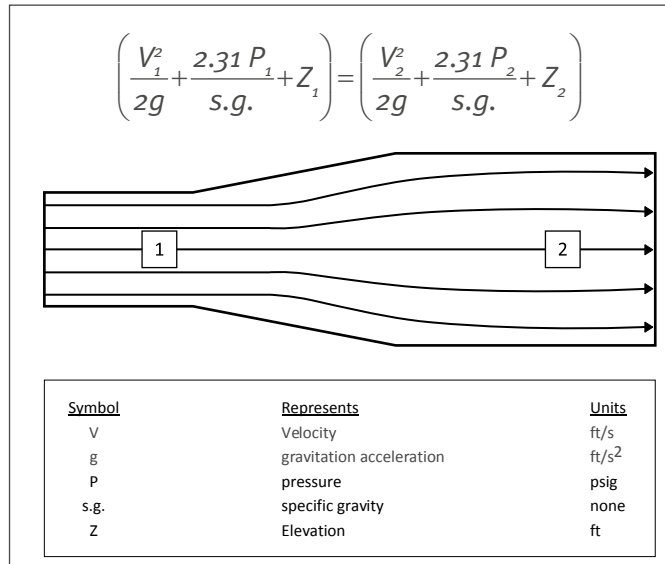


Fig. 12.7. Bernoulli’s Law

The energy content is usually expressed as head and measured in meters. The sum of elevation head and the pressure is called “static head”. The reason it is called static is that in many systems it is fairly independent of flow rate.

The combination of static and friction head equals the total pressure in a system. The resistance a pump sees as it is pushing fluid through a system is described with a system curve. This curve has two components, the frictional resistance and the static head:

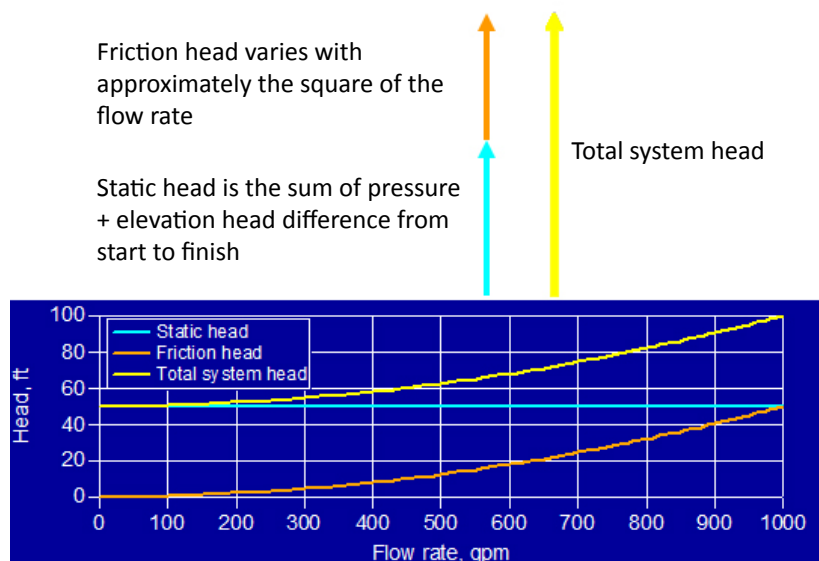


Fig. 12.8. Combination of Static Head and Friction Head



## 12.5. Field Measurements Collection Process

As you collect your testing equipment and begin to head off to the plant to investigate the pump systems that appear to have the most energy saving potential, it may take several trips to collect all the data needed. Some of the reasons for this include:

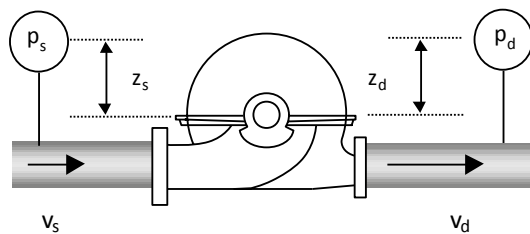
- The pump may support a critical process at that time and the facility staff does not want to take a chance that during testing the pump could be tripped.
- No pressure taps are available – or the pressure taps do not have working isolation valves.
- Some of the data may be questionable and other testing methods may need to be developed to verify data (such as a tank pump down test to verify flow).
- An electrician was not available to assist with the testing.

Be prepared to make a return visit as part of your testing schedule and remember that it is important to take the time to get good data, even taking several measurements using different methods along with detailed notes and photos of the pump system.

### 12.5.1. Collecting Pressure Data to Determine Total Pump Head

#### 12.5.1.1. Pump System Configurations

Pressure measurements before and after the pump provide the information needed to calculate total pump head. In some cases this will be a fairly straightforward process, as shown in Figure 12.9, where gauge taps are installed on the suction and discharge piping at the same elevation.

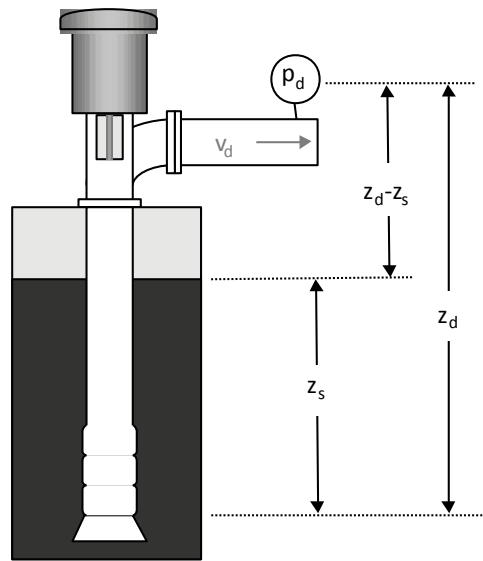


$$H_p = \left( \frac{v_d^2 - v_s^2}{2g} \right) + \frac{2.31}{s.g.} (p_d - p_s) + (z_d - z_s)$$

Symbol	Represents	Units
$g$	gravitational constant	$msec^2$
$H_p$	pump head	$m$
$p$	pressure	$kPa$
$s.g.$	fluid specific gravity	dimensionless
$v$	fluid velocity	$m/sec$
$z$	elevation	$m$
subscripts:	-----	-----
$d$	discharge	n/a
$s$	suction	n/a

**Fig. 12.9.** Calculating Pump Head With Closed Suction Piping

However, there are many different types of pump configurations that will be encountered during field-testing. In the case of Figure 12.10, it is not as simple as reading gauges on each side of the pump. On one hand, no suction measurement is needed as the pump bowls are submerged in the tank, but on the other hand, the discharge side of the pump bowls, the fluid travels through the pump shaft column and out through the discharge flange before a gauge measures the discharge pressure after that point. For this arrangement, the friction losses must be estimated when it cannot be measured by pressure gauges.



$$H_p = \frac{v_d^2}{2g} + \frac{2.31 P_d}{s.g.} + (z_d - z_s)$$

**Fig. 12.10.** Open Suction and Remote Discharge Gauge Location

One method to calculate unknown losses is provided by a feature in the PSAT 2008 programme created by Diagnostic Solutions shown in Figure 12.11. This program allows the user to add up component K values when gauges cannot measure the pressure losses to provide a more accurate method to calculate total head.

$K_s$  represents all suction losses from the tank to the pump  
 $K_d$  represents all discharge losses from the pump to gauge  $P_d$

Suction pipe diameter (ID), inches	16.000	Discharge pipe diameter (ID), inches	12.000
Suction tank gas overpressure ( $P_g$ ), psig	0.00	Discharge gauge pressure ( $P_d$ ), psig	135.00
Suction tank fluid surface elevation ( $Z_s$ ), feet	-5.00	Discharge gauge elevation ( $Z_d$ ), feet	3.00
Suction line loss coefficients, $K_s$	0.00	Discharge line loss coefficients, $K_d$	2.00
Fluid specific gravity	1.000	Flow rate, gpm	2350
<input type="button" value="Don't update"/> <input type="button" value="Accept and update"/>		Differential elevation head, ft	8.00
<input type="button" value="Click to leave the main panel head unchanged"/> <input type="button" value="Click to Accept and return the calculated head"/>		Differential pressure head, ft	311.85
		Differential velocity head, ft	0.69
		Estimated suction friction head, ft	0.00
		Estimated discharge friction head, ft	1.38
		Pump head, ft	321.92

**Fig. 12.11.** Pump head Calculator W/ Component Loss Calculator

### 12.5.1.2. Pressure measurements

Most systems in industry have pressure gauges of the Bourdon type, as shown in Figure 12.12. The Bourdon type pressure transducer consists of a C-formed tube, which tries to straighten itself when subjected to internal pressure. Mechanical linkage moves a hand that indicates pressure.



As seen above, (although no longer connected) the pressure gauge in Figure 12.13 still shows a reading of approximately 50. Not the type of gauge you want to use to get accurate field pressure values.

To obtain accurate pressure measurements, it is recommended that the existing gauges are removed and a portable pressure instrument, such the one shown in Figure 12.14 is used. Diaphragm-based strain gauge transducers are used instead. These meters are hooked up to a multi-meter to display pressure.

Strain gauge transducers are susceptible to thermal drift as shown below in Figure 12.15.

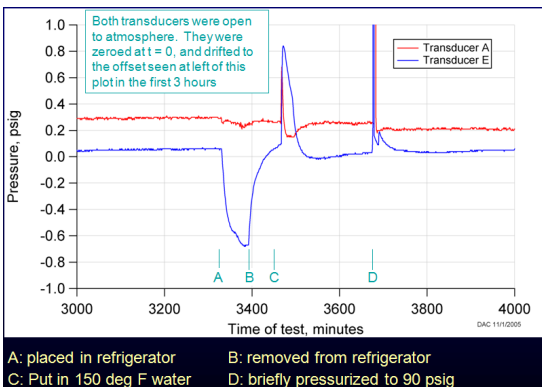
**Fig. 12.12.** Bourdon Type Pressure Gauge



**Fig. 12.13.** Fluke Pressure Transducer

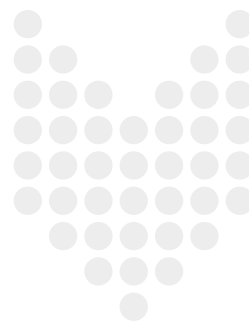


**Fig. 12.14.** Inaccurate Pressure Gauge and PV-350 Pressure Indicator



A: placed in refrigerator      B: removed from refrigerator  
C: Put in 150 deg F water      D: briefly pressurized to 90 psig

**Fig. 12.15.** Thermal and transient effects on strain gauge pressure transducers



It is therefore good practice to let them warm up and zero them before measurements are taken. Transducers can also be hooked up to a common pressure and checked so that all read the same pressure. When pressure transducers have been hooked up to a system for a longer period of time it is recommended that they be checked for offset at removal.

Measurement of *pump head* cannot be done by one direct measurement. It involves several measurements that have to be combined in order to get the right result.

In Figure 12.16, the tap is close to the pump. However, in many cases there are losses between the pump discharge and the point where pressure is measured. These losses have to be estimated and included in the calculations in order not to underestimate the fluid power delivered by the pump. If there is a difference in pipe diameters between suction and discharge, this will influence the velocity head and thus has to be included.

PSAT has a built in head calculator that does the necessary calculations. There are two variants, see Figure 12.17, of the head calculator corresponding to common industrial pump configurations. Once the appropriate (blue) boxes have been filled with numbers PSAT will perform the calculations and transfer them to the main programme.



Fig. 12.16. Taps for Measuring Suction and Discharge Pressure

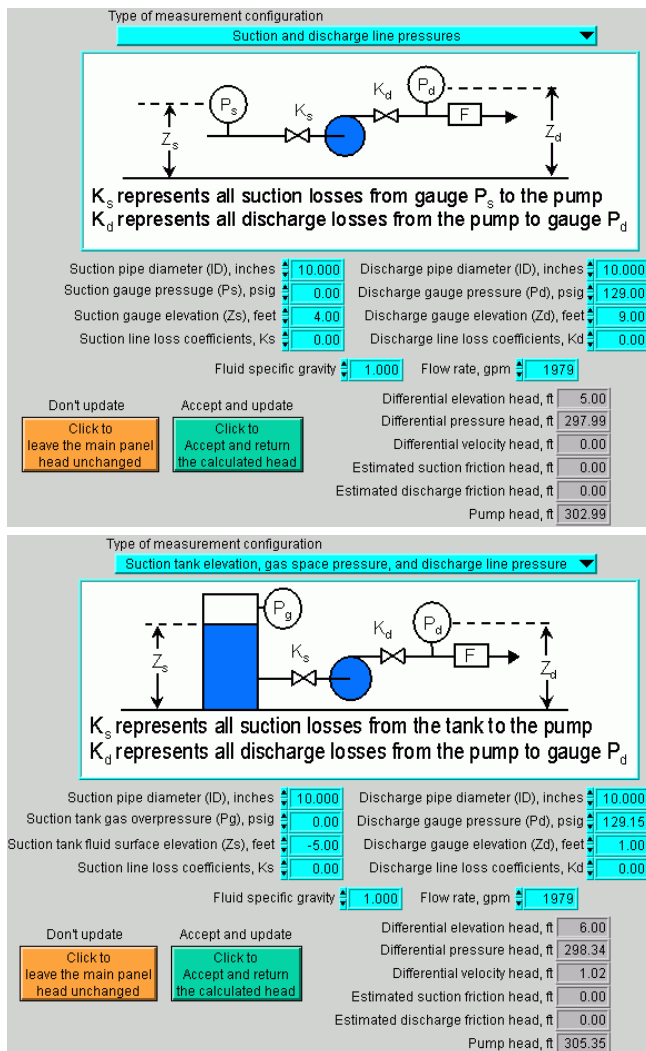


Fig. 12.17. Taps for Measuring Suction and Discharge Pressure



When the losses between pump and measuring point are estimated, the accuracy of the estimate is not always very good. There are often large differences between generic and specific losses. See Figure 12.18

Approximate Range of Variation for <i>K</i> (From Hydraulic Institute Engineering Data Book, 2 <sup>nd</sup> edition)		
Fitting		Range of Variation
90 Deg. Elbow	Regular Screwed	± 20 per cent above 2 inch size
	Regular Screwed	± 40 per cent above 2 inch size
	Long Radius, Screwed	± 25 per cent
	Regular Flanged	± 35 per cent
	Long Radius, Flanged	± 30 per cent
45 Deg. Elbow	Regular Screwed	± 10 per cent
	Long Radius, Screwed	± 10 per cent
110 Deg. Bend	Regular Screwed	± 25 per cent
	Regular Flanged	± 35 per cent
	Long Radius, Screwed	± 30 per cent
Tee	Screwed, Line or Branch Flow	± 25 per cent
	Flanged, Line or Branch Flow	± 35 per cent
Global Valve	Screwed	± 25 per cent
	Flanged	± 25 per cent
Gate Valve	Screwed	± 25 per cent
	Flanged	± 50 per cent
Check Valve	Screwed	± 30 per cent
	Flanged	+ 200 per cent / - 80 per cent

**Fig. 12.18.** Generic Loss Coefficients

It is therefore a good idea to input different estimates of the loss coefficients to see how much influence they have on the pump head calculation. See Figure 12.19. In most industrial applications this influence is minor.

**Fig. 12.19.** Checking the influence of loss coefficients on head calculations

**Case 1A**

Discharge pipe diameter (ID), inches

Discharge gauge pressure (Pd), psig

Discharge gauge elevation (Zd), feet

Discharge line loss coefficients, Kd

Flow rate, gpm

Differential elevation head, ft

Differential pressure head, ft

Differential velocity head, ft

Estimated suction friction head, ft

Estimated discharge friction head, ft

Pump head, ft

**4 x loss => 1% change in head**

**Case 1B**

Discharge pipe diameter (ID), inches

Discharge gauge pressure (Pd), psig

Discharge gauge elevation (Zd), feet

Discharge line loss coefficients, Kd

Flow rate, gpm

Differential elevation head, ft

Differential pressure head, ft

Differential velocity head, ft

Estimated suction friction head, ft

Estimated discharge friction head, ft

Pump head, ft



### Case 2A

Discharge pipe diameter (ID), inches	16.000
Discharge gauge pressure (Pd), psig	30.00
Discharge gauge elevation (Zd), feet	1.00
Discharge line loss coefficients, Kd	5.00
Flow rate, gpm	7000
Differential elevation head, ft	6.00
Differential pressure head, ft	69.30
Differential velocity head, ft	1.94
Estimated suction friction head, ft	0.00
Estimated discharge friction head, ft	9.69
Pump head, ft	86.93

**2 x loss => 11% change in head**

### Case 2B

Discharge pipe diameter (ID), inches	16.000
Discharge gauge pressure (Pd), psig	30.00
Discharge gauge elevation (Zd), feet	1.00
Discharge line loss coefficients, Kd	10.00
Flow rate, gpm	7000
Differential elevation head, ft	6.00
Differential pressure head, ft	69.30
Differential velocity head, ft	1.94
Estimated suction friction head, ft	0.00
Estimated discharge friction head, ft	19.39
Pump head, ft	96.63

### 12.5.2. Flow Measurements

Flow measurements are usually the most difficult measurements when assessing pump systems. There are a large number of different methods to measure flow that include:

- Differential pressure- orifice, venturi, nozzle.
- Velocity - magnetic, ultrasonic, propeller (turbine), paddlewheel, vortex shedding.
- Open flow - Weir

These are based on different principles but common issues are that the flow profile has to be fully developed in order to obtain accurate measurements. To develop a full flow profile usually takes about 10 diameters of pipe length. It is therefore recommended that a straight pipe of ten diameters length is installed upstream of a flow meter. The flow meter is also influenced by irregularities downstream of the meter. It is recommended to have at least 5 diameters of straight pipe downstream of the meter as well.

Many flow meters use Bernoulli's equation to calculate flow, as shown in Figure 12.20.

$$\left( \frac{V_1^2}{2g} + \frac{2.31 P_1}{s.g.} + Z_1 \right) = \left( \frac{V_2^2}{2g} + \frac{2.31 P_2}{s.g.} + Z_2 \right)$$

$g = 32.174$	gravitational acceleration	ft/s <sup>2</sup>
$P$	pressure	psi
$s.g.$	fluid specific gravity	dimensionless
$V$	velocity	ft/s
$Z$	elevation	ft

*Manipulating equations give us:*

$$V_1 \text{ (ft/s)} = 12.194 \sqrt{\frac{\beta^4 dP}{s.g. (1-\beta^4)}}$$

*or*

$$Q \text{ (gmp)} = 29.851 d_2^2 \sqrt{\frac{dP}{s.g. (1-\beta^4)}}$$

where,

$$\beta = \frac{d_2}{d_1}$$

**Fig. 12.20.** Bernoulli's Equation



Some flow meters like venture and especially orifice meters create a constant pressure drop in the line and thus consume energy that has to be paid for via the motor's energy use.

Permanently installed magnetic flow meters are usually accurate and reliable. They also have to have good flow conditions upstream and downstream of the meter in order to take full advantage of their accuracy.

At systems where there are no installed flow meters a possible solution is to use portable ultrasonic flow meters. These meters usually work well, but don't function with all sorts of liquids. They usually have problems with liquids containing particles or bubbles. Many of them have a built in function that reports when a measurement is unreliable, but the user should still be aware of the possibility that the measurements are unreliable in such instances.

As the sound signal has to pass through both the wall and the liquid, the wall thickness has to be measured and compensated for. Flow meters are frequently calibrated against draw down or fill rates of tanks with known volumes.

There are several different types of portable flow meters that operate on a number of principles. Some of these are discussed below.

#### 12.5.2.1. Pitot Tubes

Pitot tubes are sometimes used as temporary, portable flow meters. They are more commonly used in agricultural or municipal services where the system can be shut down and the test connection location isolated to allow the installation, versus industrial applications where process shut down is often not possible.

A close-up picture of a customized pitot tube is shown at the left side of Figure 12.21 the overall test assembly, including the manometer used to indicate differential pressure is shown at the right.

The testing being done in Figure 12.21 used a multiport pickup. This minimizes errors associated with positioning and disturbed flow profiles.

#### 12.5.2.2. Ultrasonic Flow Meters

Ultrasonic technology is used for permanent flow monitoring, but is probably better known for its application in portable units. There are two basic types of technology that are employed: Doppler and time-of-flight.

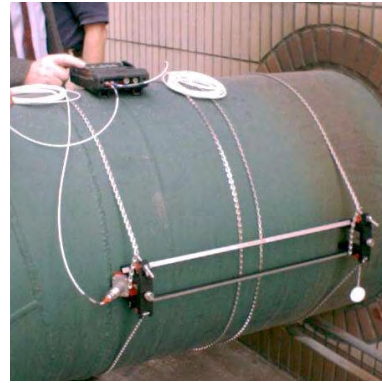
The Doppler technique relies on detection of a shift in the frequency of an ultrasonic signal associated with the fluid velocity. Doppler technology requires that there be some level of impurities (or gas bubbles) in the fluid to work effectively.



**Fig. 12.21.** Flow Reading with a Multi-port Pitot Tube

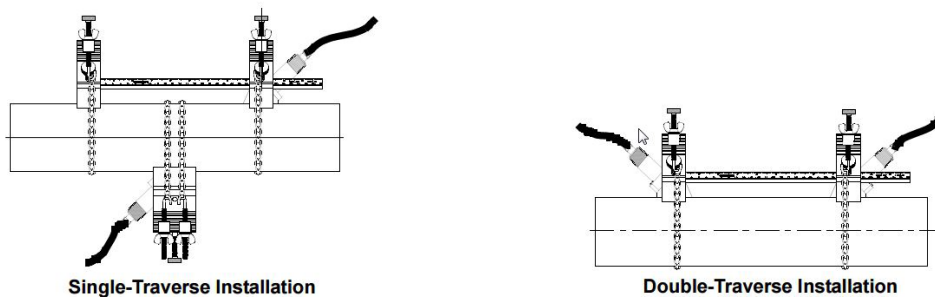


The time of flight technology is, as the name suggests, a time-based technique. A transit time ultrasonic flow meter is shown in Figure 12.22. This type of meter measures the ultrasonic pulses in a fluid to calculate flow velocity.



**Fig. 12.22.** Transit-time ultrasonic flow meter

Depending on the configuration, the signal may be reflected off the pipe walls as shown above with the double traverse method or transmitted across the pipe as shown in the single transverse method in Figure 12.23.



**Fig. 12.23.** Single and Double Traverse Methods  
(courtesy of GE Panametrics)

The equipment manufacturer for the flow meter shown in Figure 12.23 advises users to first attempt the double traverse installation for mounting the transducers. The reasons for this include:

- Accuracy is improved because the signal is in the fluid longer
- The double traverse installation is usually easier to install

Whether the double or single traverse method is used, it is important to install the transducers on the sides of the pipe instead of the top and bottom to avoid potential errors that could be caused by air collected in the top of the pipe and sediment that collected in the bottom. Installation must also be done on a straight length of pipe with 10 diameters of “undisturbed piping” upstream of the transducers and 5 diameters downstream. Undisturbed pipe means avoiding potential sources of turbulence such as flanges, elbows and tees.

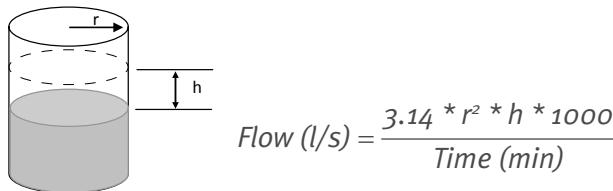


One of the important features of portable meter setup is wall thickness, particularly in smaller diameter piping. The wall thickness and outer diameter are two of the parameters that must be input to the controller (along with material type and fluid properties) before it can designate transducer axial spacing. The meter shown in Figure 12.22 is also equipped with a transducer to determine pipe wall thickness.

It should be noted that this meter has not been successful in every application. Two particular circumstances have prevented it from working – a high level of scale buildup on the inside of the pipe wall, and a high level of aeration in the pumped fluid.

**12.5.2.3. Pump Down Test**

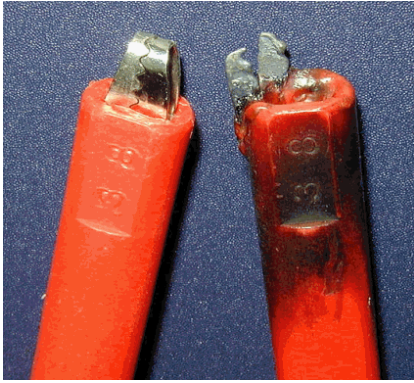
To check existing flow meters or as an alternative to using an ultrasonic flow meter, filling up or pumping water out of a tank can also calculate the pump system flow. Simply isolating the tank, measuring the existing level and activating the pump over a given time frame will determine the gallons pumped out of (or into) the tank. This method is illustrated below with the corresponding equation for a round tank.



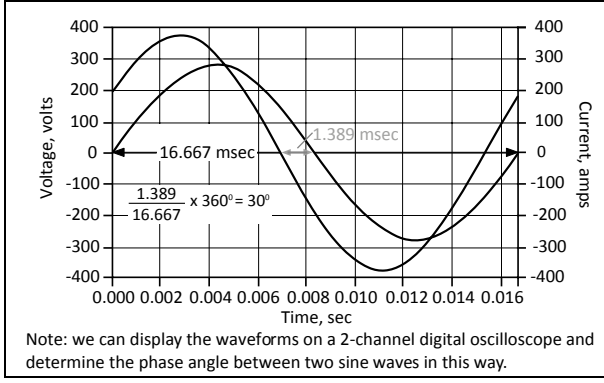
**Fig. 12.24.** Determining Flow From Tank Volume

**12.5.3. Electrical Measurements**

Electrical measurements should only be taken by qualified electricians or trained technical specialists. One thing worth repeating is the importance of proper safety precautions when taking any electrical measurements. The National Electrical Code discusses safety guidelines and qualifications for people working around switchgear. There are also OSHA regulations, which follow the code guidelines. Short circuits can create very high current levels, with the potential to melt or vaporize conductors. The two jaws of a test probe, shown in Figure 12.25, were accidentally put in contact across two phases. Even though the breaker tripped to isolate the short circuit, it did not occur before the lead exploded. The sound from the explosion was similar to that of a shotgun.



**Fig. 12.25.** Normal and Vaporized Test Lead



**Fig. 12.26.** Time Between Zero crossings of the Waveforms

Power can be measured directly or calculated from voltage and ampere measurements. The calculation of power from these measurements cannot be done without estimating the power factor that is the cosine of the phase angle between voltage and current waveforms, as shown below in Figure 12.26.

PSAT has a built in power factor estimator that is very good compared to other estimators on the market.

### 12.5.3.1. Voltage

Of the measured parameters, the voltage will generally have the least impact on the calculated results. This is not because voltage is unimportant, but rather because voltage normally varies by a relatively small amount in comparison with the other parameters. For example, it is very unusual for voltage to depart from nominal by more than 10% during normal, steady state conditions.

Voltage can usually be found displayed on panel meters (analog or digital) at motor control centers, particularly if the motor is powered from a medium voltage bus. In many situations where low voltage (e.g. 230- or 460-volt motors) is applied, there may not be a permanently installed bus voltage indicator.

From a field measurement standpoint, it is advisable to measure the three phase-to-phase voltages, as shown in Figure 12.27. The average of the three readings should then be used.



Fig. 12.27. Voltage Readings

### 12.5.3.2. Amperage

It is important, when possible, to monitor all three phases of current, as shown in Figure 12.29, and average the three. This is particularly important if the voltage is unbalanced because the current can vary significantly from phase to phase as the voltage gets progressively more unbalanced.



Fig. 12.28. Monitoring all Three Phases



Fig. 12.29. Amp Measurements for Each Phase



### **Measuring Current with Capacitor Banks Installed**

In some instances, power factor-correcting capacitors are connected in parallel with the motor. When capacitors are paralleled to the motor, it is important to monitor current to the motor, *not* current to the combined capacitor and motor.

In situations where capacitors are installed, it is important that the current measured for PSAT purposes be the current going to the motor, *not* the incoming current from the line which will be lower than that to the motor because of the capacitor bank. The reason is that the PSAT estimation methodology uses motor performance characteristics to estimate shaft load, and the *motor* power factor is inherent in the data used by PSAT.

Electric power measurement is the preferred method of estimating shaft power. But the measurement of current and voltage alone (i.e. no power meter available) normally provides reasonably accurate results, provided that factors such as capacitor banks be recognized and accounted for.

### **Measuring Current for Adjustable Frequency Drive Applications**

Adjustable frequency drives present another challenge when using current to evaluate pump system energy use. The motor may be operating at quite a different speed than that which it was rated, so measurement of current to the motor is problematic. Adjustable frequency drives employ rectifiers at the front end of the drive, and the drive power factors tend to be very high, with high displacement power factors of around 0.95.

For pump system data collection, the use of drive input power is strongly encouraged as the load estimating method. Some drives output power on a drive digital display and/or as an analog output. If not, a portable power meter can be used.

As a fallback position, where power is not reported by the drive and a power meter is not available, the three-phase average drive input current and phase-to-phase voltages can be measured and then power estimated using an assumed power factor of 0.95 (or other value suggested by the drive manufacturer). The calculation is as follows:

$$\text{Power (kW)} = \text{Average voltage} \times \text{Average current} \times 0.95 \times 1.732 / 1000$$

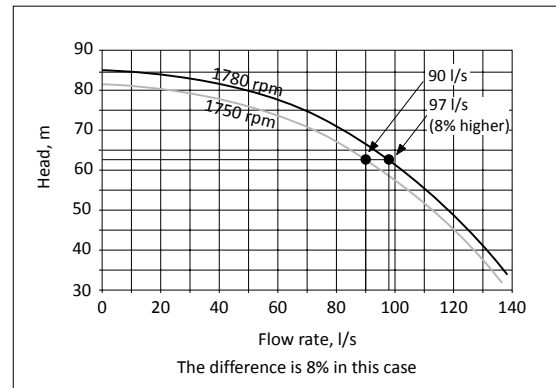
#### **12.5.3.3. Power**

Measuring kW is the preferred method to evaluate pump power consumption. The reason that motor input electric power is preferred is that it is only one step removed from shaft power, namely the motor efficiency.

When motor current is used, there are two variables at play – the efficiency and power factor. As both power factor and efficiency vary with load and motor type, there is increased uncertainty in the shaft power estimate from the motor current.

### **12.5.4. Checking Rotational Speed**

It is important to check rotational speed to determine if any adjustments should be made when comparing the flow and head data to the original pump curve. An example of how RPMs can affect flow is shown on Figure 12.30.



**Fig. 12.30.** Taking RPM Readings

RPMs can be measured easily with a non-contact strobe type tachometer as shown in Figure 12.30. In most cases, there will be nicks or scratches on the shaft that can be seen when the strobe light is aimed at the shaft and no reflective tape is needed. The knobs on the strobe light are adjusted until the shaft marks appear to be motionless, at that point the corresponding RPM reading can be recorded.

It is important for the user to be aware that the initial RPM for the strobe light must first be adjusted close to what the true RPM is. The reason for this is that if you begin taking readings at 3600-RPM for an 1800-RPM pump, it will appear to be adjusted correctly as the value is a multiple of the true reading. This is especially important when working with low RPM pumps that may be equipped with variable speed drives.

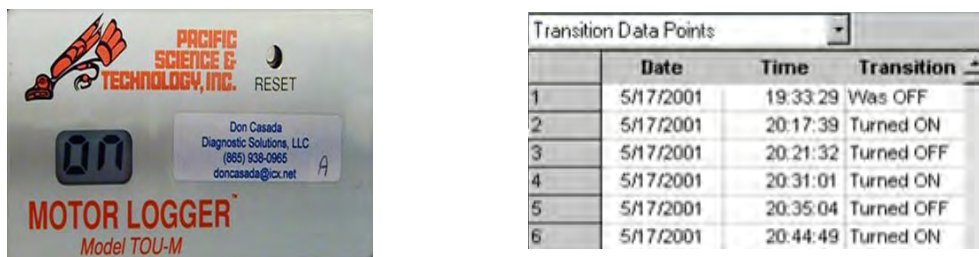
### 12.5.5. Data Logging

#### 12.5.5.1. Motor On/Off loggers

One of the simplest, yet very helpful, loggers is a simple On/Off logger. The logger shown in Figure 12.31 is installed adjacent to a motor circuit breaker (held in place by a Velcro strap). The logger indicates “on” because the motor is running.

This type of logger is sensitive to the ambient magnetic field strength and can be strapped on the motor or power leads as well. Other loggers use clamp-on current transformers for the same purpose.

Examples of the way the data is stored and summary results from a month’s operation are shown in Figure 12.31.



**Fig. 12.31.** On/Off Logger and Data Output





### 12.5.5.2. General-purpose data loggers

General-purpose loggers can be used to log general analog signals. Depending on the particular logger features, the types and ranges of signals that can be logged vary. Common signal types such as 0-5 volts dc, 4-20 milliamps and TTL pulse counts are the most common. With some loggers, the signal scaling can be set up to store both the literal signal amplitude and the individual transducer scaling so that when the data is subsequently retrieved, the values reported are in the properly scaled engineering units.

Signal sample rates for these types of loggers can typically be varied from a couple of hundred per second to once every 12 hours; some include averaging features so that the value reported over long periods is not the instantaneous value at the time of reading, but the average over the preceding period.

Figure 12.32 shows a general-purpose logger with amperage CT that can be clipped on to one leg of a three-phase circuit. This logger has the capability of logging 4 input signals. Typically, the user activates the logger in the field with a laptop computer after selecting the desired logging interval. When the logger is picked later, the unit is plugged back into the logger and the data is downloaded into an Excel file for analysis.



**Fig. 12.32.** General Purpose Data Logger

## 12.6. Key Learning Points

Key learning points for this chapter includes:

- Collecting pump data before taking field measurements
- Equipment and tools needed for field measurements
- Types of instrumentation and recording data:
  - Nameplate data
  - Rotational speed
  - Pressure and determination of total pump head
  - Flow measurements
  - Electrical measurements
- Using data loggers

## 13. WORKING WITH THE DATA

---

### 13.1. Overview

This Chapter reviews what to do with the data after it has been collected. Prior to beginning this process, the pump user should have assembled the following equipment information:

- Copy of pump curve
- Drawings of system with elevations
- Motor and Pump nameplate data
- Equipment data/specifications when available

As part of pump testing data collection effort the following information should also have been collected for various flow intervals:

- Determination of *system* flow and pressure requirements
- Pump pressure measurements
- Flow measurements
- Electric data (amperage, voltage, kW)
- RPMs
- Hours of operation

With this information, the user can begin analyzing the data.

### 13.2. Developing a System Curve

As discussed, the most important first step during a pump system evaluation is to develop the system curve. After the needed data has been collected, this process is relatively easy as shown in the figures 13.1 through 13.4.

The diagram in Figure 13.1 shows a simple pump system with pressure readings taken at  $P_1$ ,  $P_2$ ,  $P_3$  and  $P_4$ . To develop a system curve, the total head must first be calculated by finding the static and friction head (velocity head will be considered negligible for this example). Figure 13.2 illustrates how the static head is determined.



Once the static head has been determined, the frictional head can now be calculated at one flow rate. This is done by simply taking the pressure measurements on the suction and discharge of the pump and converting pressure to meters of head, as shown in Figure 13.3

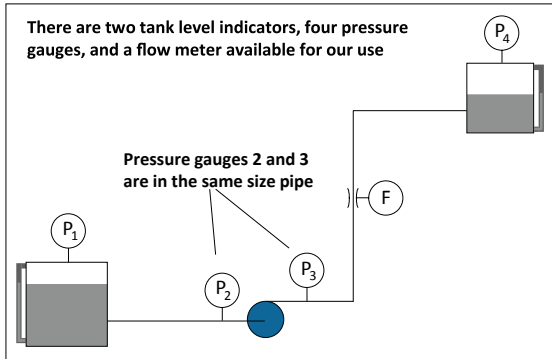


Fig. 13.1. Example System Diagram

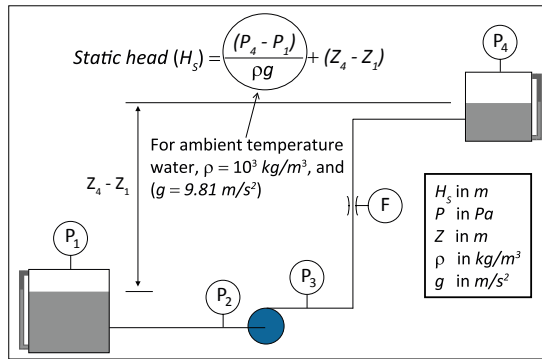


Fig. 13.2. Calculating static head (a)

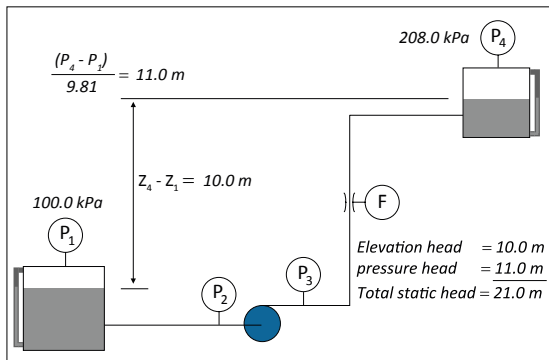


Fig. 13.2. Calculating static head (b)

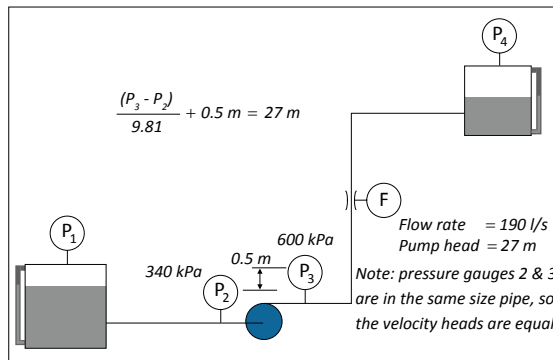


Fig. 13.3. Calculating friction head

Now that we have two points on the system curve (21 m at 0 l/s and 27 m at 190 l/s), a system curve can be developed using the following equations:

$$K = \frac{H_2 - H_1}{Q_2^2 - Q_1^2} \quad \text{and} \quad H_3 = H_1 + K * Q_3^2$$

Eq. 13.1. Calculating system curve points

Where  $H_3$  and  $Q_3$  represent head and flow at any other point on the system curve. When enough points are developed a system curve is constructed, as shown in Figure 13.4.

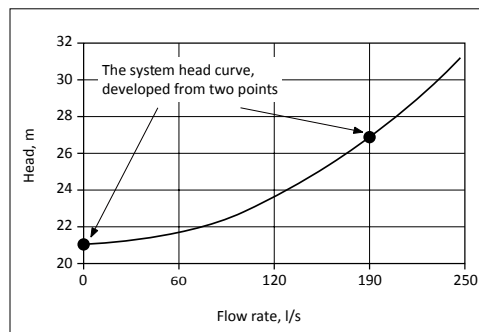
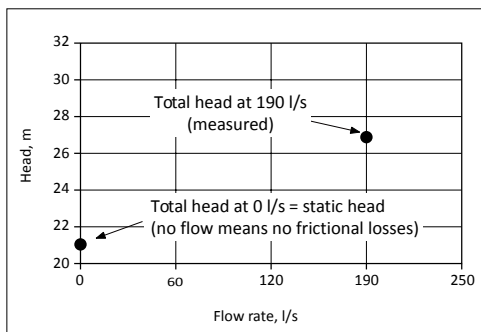


Fig. 13.4. System Curve Development



Now that a system curve has been developed, the system requirements can be reviewed in more detail to evaluate potential areas of improvement. Some of these considerations should include:

- Can the system curve be changed to improve efficiency?
- Is the pump operating point matched to what the system needs?
- Can the pump operate at a lower point on the system curve and still satisfy system needs?

As these issues are considered, the collected pump data should also be reviewed for each flow interval. The data can be organized as shown in Table 13.1.

**Table 13.1.** Data Collection Table

Interval	Pump Flow	Total Head	kW or Amperage	RPMs	Annual Hours	kWhs
1						
2						
3						
4						
5						

At this point, the user can begin the process of comparing how efficiently the pump system is matched to the system requirements.

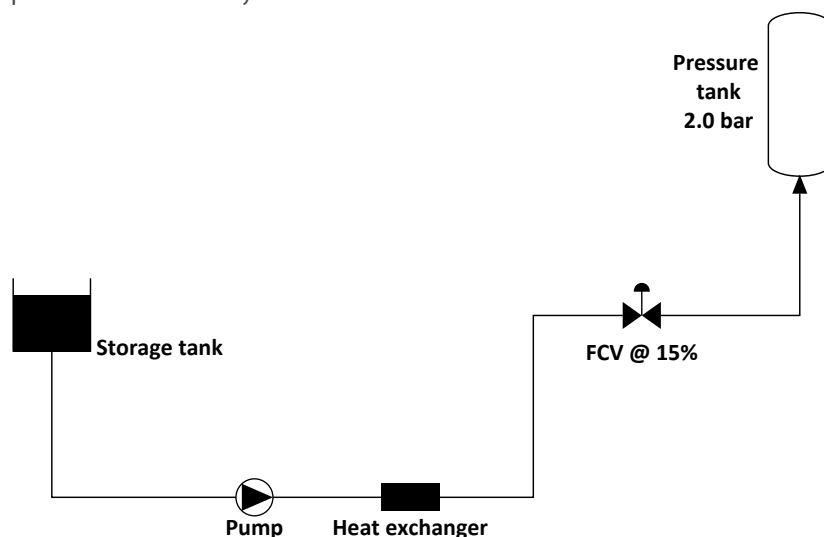
## 14. EXAMPLE PROBLEM

### 14.1. System with a Problem Control Valve

In this example the LCC analysis for the piping system is directed at a control valve. The system is a single pump circuit that transports a process fluid containing some solids from a storage tank to a pressurized tank. A heat exchanger heats the fluid and a control valve regulates the rate of flow into the pressurized tank to 80 m<sup>3</sup>/h (350 USgpm).

The plant engineer experiences problems with a control valve that fails as a result of erosion caused by cavitation. The valve fails every 10 to 12 months at a cost of 4000 Euro or USD per repair. A change to the control valve is being considered to replace the existing valve with one that can resist cavitation.

Before changing out the control valve again, the project engineer wanted to look at other options and perform a LCC analysis on alternative solutions.



**Fig. 14.1.** Sketch of pumping system in which the control valve fails. Storage tank, Pump, Heat exchanger, FCV @ 15%, Pressure tank 2.0 Bar

**How the system operates:**

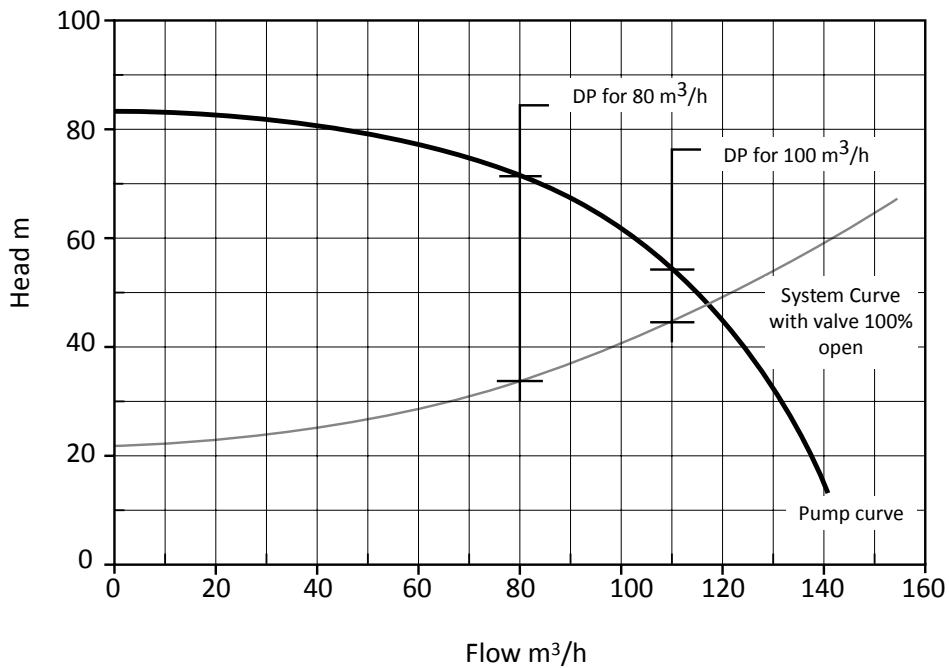
The first step is to determine how the system is operating and to determine why the control valve fails, then to see what can be done to correct the problem.

The control valve currently operates between 15 to 20 percent open and with considerable cavitation noise from the valve. It appears the valve was not sized properly for the application. After reviewing the original design calculations, it was discovered that the pump was sized for 110 m<sup>3</sup>/h (485 USgpm) instead of 80 m<sup>3</sup>/h (350 USgpm) resulting in a larger pressure drop across the control valve than originally intended.

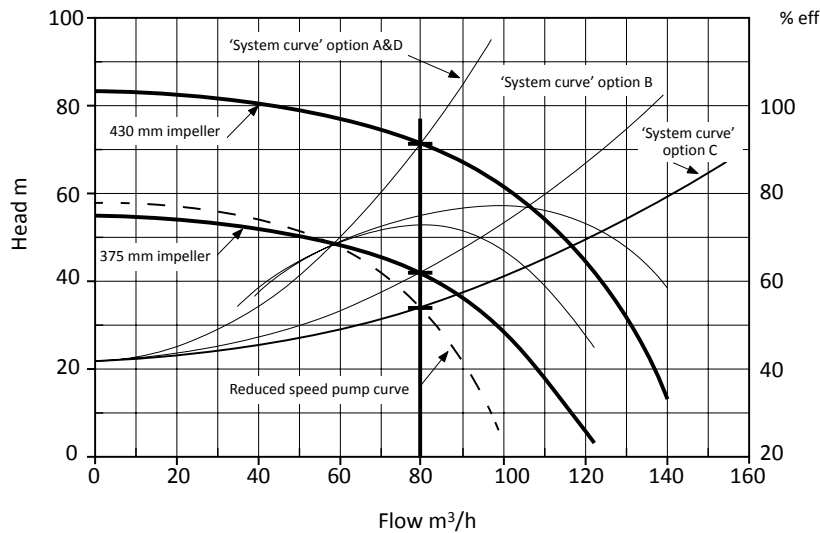
As a result of the large differential pressure at the operating rate of flow, and the fact that the valve is showing cavitation damage with regular intervals, it is determined that the control valve is not suitable for this process. The following four options are suggested:

- A.** A new control valve can be installed to accommodate the high-pressure differential.
- B.** The pump impeller can be trimmed so that the pump does not develop as much head, resulting in a lower pressure drop across the current valve.
- C.** An adjustable speed drive (such as a variable frequency drive [VFD]) can be installed and the flow control valve removed. The VFD can vary the pump speed and thus achieve the desired process flow.
- D.** The system can be left as it is, with a yearly repair of the flow control valve to be expected.

The cost of a new control valve that is properly sized is 5000 Euro or USD. The cost of modifying the pump performance by reduction of the impeller diameter is 2250 Euro or USD. The process operates at 80 m<sup>3</sup>/h for 6000 h/year. The energy cost is 0.08 Euro or USD per kWh and the motor efficiency is 90 percent.



**Fig. 14.2.** Pump and system curves



**Fig. 14.3.** Pump and system curves for impeller trimming, variable speed operation, and different system curves

By trimming the impeller to 375 mm, the pump’s total head is reduced to 42 m (138 ft) at 80 m<sup>3</sup>/h. This drop in pressure reduces the differential pressure across the control valve to less than 10 m (33 ft), which better matches the valve’s original design point. The resulting annual energy cost with the smaller impeller is 6720 Euro or USD. It costs 2250 Euro or USD to trim the impeller. This includes the machining cost as well as the cost to disassemble and reassemble the pump. A 30 kW VFD costs 20 000 Euro or USD, and an additional 1500 Euro or USD to install. The VFD will cost 500 Euro or USD to maintain each year. It is assumed that it will not need any repairs over the project’s 8-year life.

The option to leave the system unchanged will result in a yearly cost of 4000 Euro or USD for repairs to the cavitating flow control valve.

**Table 14.1.** Cost comparison for Options A through D in the system with a failing control valve.

Cost	Change Control Valve (A)	Trim Impeller (B)	VFD (C)	Repair Control Valve (D)
<b>Pump Cost Data</b>				
Impeller diameter	430 mm	375 mm	430 mm	430 mm
Pump head	71.7 m (235 ft)	42.0 m (138 ft)	34.5 m (113 ft)	71.7 m (235 ft)
Pump efficiency	75.1%	72.7%	77%	75.1%
Rate of flow	80 m <sup>3</sup> /h (350 USgpm)	80 m <sup>3</sup> /h (350 USgpm)	80 m <sup>3</sup> /h (350 USgpm)	80 m <sup>3</sup> /h (350 USgpm)
Power consumed	23.1 kW	14.0 kW	11.6 kW	23.1 kW
<b>Energy Cost Per Year</b>	11 088 Euro or USD	6720 Euro or USD	5568 Euro or USD	11 088 Euro or USD
<b>New Valve</b>	5000 Euro or USD	0	0	0
<b>Modify impeller</b>	0	2250 Euro or USD	0	0
<b>VDF</b>	0	0	20 000 Euro or USD	0
<b>Installation of VDF</b>	0	0	1500 Euro or USD	0
<b>Valve repair/year</b>	0	0	0	4000 Euro or USD

**14.1.1. Discuss:**

1. What benefits do you see in the different solutions?

2. Which would you recommend and why?







## 15.2. Appendix B: PSAT Manual

# Pumping System Assessment Tool User's Manual

### 15.2.1. About this manual

The Pumping System Assessment Tool (PSAT) is designed to allow users to evaluate the potential energy saving opportunities of pumping systems based on field-measured data. This user's guide document gives basic information about the data entry items, the calculated results and assorted control button features. It is not intended to provide a tutorial on how to obtain field data or perform pumping system evaluations. The U.S. Department of Energy sponsors both end-user and specialist workshops on those subjects. International affiliates are also undertaking similar efforts. A listing of currently planned training sessions is available on the web at: <http://www1.eere.energy.gov/industry/bestpractices/training.html>

#### Support from the U.S. Department of Energy

The U.S. Department of Energy supports the operation of the EERE Information Center at: [http://www1.eere.energy.gov/industry/bestpractices/info\\_center.html](http://www1.eere.energy.gov/industry/bestpractices/info_center.html)

Users may call (1-877-337-3463) or e-mail ([eeeric@ee.doe.gov](mailto:eeeric@ee.doe.gov)) the EERE Information Center with questions about program operation or technical questions related to pumping systems operating efficiency.

The screenshot displays the PSAT main panel layout, organized into several sections:

- Condition A and Condition B Input Panels:** Each panel includes fields for Pump fluid (End suction ANSI/API), Pump rpm, Drive (Direct drive), Units (gpm, ft, hp for A; L/s, m, kW for B), Kinematic viscosity (cS), Specific gravity, # stages, Fixed specific speed?, Line freq., Rated power HP, Motor rpm, Eff. class, Voltage, Estimate FLA, Full-load amps, Size margin,%, Operating fraction, \$/kwhr, Flow rate, Head, Load estim. method, Motor kW, and Voltage.
- Summary Table:** A table comparing existing and optimal values for various metrics across two conditions. The metrics include Pump efficiency, Motor rated power, Motor shaft power, Motor efficiency, Motor power factor, Motor current, Motor power, Annual energy, and Annual cost. The table also shows Annual savings potential and Optimization rating.
- Log file controls:** Buttons for Create new log, Add to existing log, Retrieve log entry, and Delete log entry.
- Summary file controls:** Buttons for Create new summary file and Existing summary files.
- Documentation section:** Fields for Facility, System, Date, Application, Evaluator, and General comments.
- Condition A Notes and Condition B Notes:** Text areas for user input.
- Navigation and Control:** Buttons for Retrieve defaults, Set defaults, Copy A to B, Copy B to A, Background information, and a prominent STOP button.

	Condition A			Condition B		
	Existing	Optimal	Units	Existing	Optimal	Units
Pump efficiency	72.6	84.8	%	72.5	85.0	%
Motor rated power	200	200	hp	150	132	kW
Motor shaft power	192.4	164.8	hp	143.8	122.7	kW
Pump shaft power	192.4	164.8	hp	143.8	122.7	kW
Motor efficiency	95.7	95.8	%	95.9	95.6	%
Motor power factor	86.7	85.7	%	86.4	86.4	%
Motor current	217.1	188.2	amps	217.9	186.4	amps
Motor power	150.0	128.4	kW	150.0	128.3	kW
Annual energy	1314.0	1125.1	MWh	1314.0	1124.1	MWh
Annual cost	65.7	56.3	\$1000	65.7	56.2	\$1000
Annual savings potential, \$1,000	9.4			9.5		
Optimization rating, %	85.6			85.5		

Fig. 15.1. PSAT main panel layout



### 15.2.2. PSAT main panel general overview

A brief overview of the major sections of the PSAT main panel is provided below. Detailed information is provided in subsequent sections.

Fig. 15.2. PSAT input section

The PSAT main panel, shown in Figure 15.1, is the primary user interface. Calculations are performed simultaneously on two independent conditions, Condition A and Condition B, shown in Figure 15.2.

While most of the inputs involve simply selecting an item from a drop-down menu or typing in the numerical value, and are discussed individually later in this guide, there are three buttons that are important to highlight.

The first is the “Estimate FLA” button (FLA = Full-Load Amps). This version of PSAT requires the user to specify the FLA even if power is used as the method to estimate motor output (shaft) power. If the motor nameplate FLA is not readily available, clicking the “Estimate FLA” button will insert a reasonable estimate for the specified motor speed, size and efficiency class.

The second button that is important to note is the “Head tool” button.

This button takes the user to the supporting head tool calculation panel, from which measured field data are translated into operating head. The head tool calculation panel is discussed in detail later in this guide.

The third button is the “Fixed specific speed?” selector. Generally speaking, it is more conservative to select YES. If, however, the basic pump design can be changed (such as number of stages adjusted) in an effort to improve achievable efficiency, NO may be chosen.

The inputs inside the yellow (Condition A) and grey (Condition B) boxes on the left side of the main panel are used by PSAT to compute the results which are shown in the correspondingly-labeled boxes in the upper right hand side of the panel, as shown in Figure 15.3. The “Existing” column reflects PSAT’s estimates of equipment (and/or system) parameters for the current operation. The “Optimal” column reflects PSAT’s estimate of top of the line, commercially available equipment performance.

The data entered under Condition A can be for the same pump as in Condition B, but measured at a different point in time, at different operating conditions, etc. Alternatively, it can be

Condition A	Condition B
End suction ANSI/API	Specified optimal eff (below)
Pump rpm: 1780	Achievable efficiency: 85.0
Drive: Direct drive	Pump rpm: 1780
Units: gpm, ft, hp	Drive: Direct drive
Kinematic viscosity (cS): 1.00	Units: L/s, m, kW
Specific gravity: 1.000	Kinematic viscosity (cS): 1.00
# stages: 1	Specific gravity: 1.000
Fixed specific speed? YES	# stages: 1
Line freq: 60 Hz	Fixed specific speed? NO
Rated power HP: 200	Line freq: 50 Hz
Motor rpm: 1780	Rated power kW: 150
Eff. class: Energy efficient	Motor rpm: 1480
Voltage: 460	Eff. class: Specified (below)
Estimate FLA	FL efficiency, %: 95.8
Full-load amps: 225.4	Voltage: 460
Size margin, %: 0	Estimate FLA
Operating fraction: 1.000	Full-load amps: 227.0
\$/kwhr: 0.0500	Size margin, %: 0
Flow rate, gpm: 2000	Operating fraction: 1.000
Head tool	\$/kwhr: 0.0500
Head, ft: 276.8	Flow rate, L/s: 126.2
Load estim. method: Power	Head tool
Motor kW: 150.0	Head, m: 84.4
Voltage: 460	Load estim. method: Power
	Motor kW: 150.0
	Voltage: 460



for another pump in the same system, a similar pump in a different facility, or a completely unrelated application. So there is no limitation on the selection of pump and motor combinations or the system of units. In the case of the inputs and results shown in Figures 15.2 and 15.3, different pump types, motors, and systems of units were used.

PSAT analysis may be saved for subsequent retrieval using the “Log file” controls buttons (Fig. 15.4) in the middle section of the display. Logging is somewhat analogous to saving a file, but it provides flexibility and retrieval of information that is not available through the normal Windows interface.

	Condition A			Condition B		
	Existing	Optimal	Units	Existing	Optimal	Units
Pump efficiency	72.6	84.8	%	72.5	85.0	%
Motor rated power	200	200	hp	150	132	kW
Motor shaft power	192.4	164.8	hp	143.8	122.7	kW
Pump shaft power	192.4	164.8	hp	143.8	122.7	kW
Motor efficiency	95.7	95.8	%	95.9	95.6	%
Motor power factor	86.7	85.7	%	86.4	86.4	%
Motor current	217.1	188.2	amps	217.9	186.4	amps
Motor power	150.0	128.4	kW	150.0	128.3	kW
Annual energy	1314.0	1125.1	MWh	1314.0	1124.1	MWh
Annual cost	65.7	56.3	\$1000	65.7	56.2	\$1000
Annual savings potential, \$1,000	9.4			9.5		
Optimization rating, %	85.6			85.5		

Fig. 15.3. PSAT results section

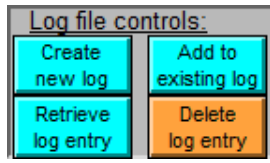


Fig. 15.4. Log file controls section

PSAT analyses can also be exported to a spreadsheet format (tab-delimited file) using the “Summary file controls” section (Fig. 15.5) in the middle right hand side of the main panel display. Existing summary files may also be appended; more detailed discussion is provided in the Log and summary files control section.

The lower right hand section of the main panel provides the user with a means to record the facility, system, application, date, name of the individual(s) performing the evaluation and general comments for each of the two “Conditions.” The Documentation section (Fig. 15.6) is especially important to the overall documentation of the analysis. Furthermore, it is available for the user to read when retrieving previously logged analysis. As in many cases, the user may have multiple sets of analysis for an individual pumping system, the documentation section is a vital portion of any saved work.



Fig. 15.5. Summary file controls section

Fig. 15.6. Documentation section

The “Retrieve defaults” and “Set defaults” buttons (Fig. 15.7) are in the lower left section of the main display, beneath the “Condition A” input section. The “Set default” button is used to define a set of input and documentation values that will automatically be displayed when starting PSAT. The “Retrieve defaults” will reset the main panel to the default values at any time (without stopping and restarting the program).

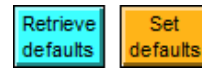


Fig. 15.7. Retrieve, Set default buttons

The “Copy A to B” and “Copy B to A” buttons (Fig. 15.8), located underneath the two Condition input sections, allow the user to quickly copy Condition A inputs to Condition B (or vice-versa). This can be especially helpful when inputting alternative conditions for the same pump, as not only will the basic nameplate type selections be the same, the line size, gauge location, etc. information that was used in calculating pump head for one condition (but is not displayed on the main panel) will automatically be transferred along with the visible main panel inputs.



Fig. 15.8. Copy Condition buttons

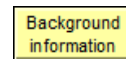


Fig. 15.9. Background info button

The “Background information” button (Fig. 15.9), located near the bottom center of the main panel, brings up a secondary panel from which the user can get more details about recommended methods for prescreening industrial systems and the underlying methods used by PSAT.

Use of the “System curve tool” menu bar (Fig. 15.10), located at the bottom left part of the main panel, can bring up a secondary panel in which the user can develop an estimated system curve for simple systems (e.g. those with a single suction source and receiving target). The system curve panel is discussed in detail later in this guide.

The “STOP” button (Fig. 15.11) allows the user to suspend calculation updating. Under normal conditions, PSAT is continuously updates the results on the main panel as input changes are made, the “STOP” button is visible at the bottom middle of the panel, and a black Run arrow (shown beside the “STOP” button in Figure 15.11) appears just below the Edit menu item.

In some situations, the user may prefer to temporarily halt PSAT without closing the application. Clicking on the “STOP” button will halt PSAT operations and cause the “Calculation updating off” alert box (Fig. 15.12) to appear and the “Run” arrow to change to white (shown beside the Calculation updating box in Figure 15.12). To make PSAT “live” again, simply click on the white Run arrow below the Edit menu. The “STOP” button will once again become visible, the “Calculation updating” alert box will disappear, and the Run arrow will change from white to black.

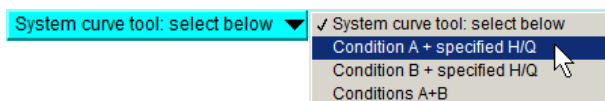


Fig. 15.10. System curve selection menu bar.



Fig. 15.11. STOP button

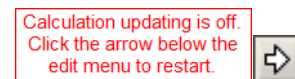


Fig. 15.12. Calculation updating off alert box.

Detailed discussions of each of the input, calculated, and control elements are provided in the balance of this guide and are organized by sections in the main display and supporting panels.



1. [Pump, fluid section](#)
2. [Motor data section](#)
3. [Duty and unit cost](#)
4. [Field data section](#)
5. [Common controls area](#)
6. [Results section](#)
7. [Documentation](#)
8. [Pump head calculation panel](#)
9. [System curve panel](#)

### 15.2.3. Pump, fluid section

<b>Pump, fluid</b>	Specified optimal eff (below) ▼
	Achievable efficiency 85.0
	Pump rpm 1780
	Drive Direct drive ▼
	Units gpm, ft, hp ▼
	Kinematic viscosity (cS) 1.00
	Specific gravity 1.000
	# stages 1
	Fixed specific speed? NO

#### Pump style

The pump style list used here is based on a listing of styles in Hydraulic Institute (HI) standard ANSI/HI 1.3-2000, American National Standard for Centrifugal Pumps for Design and Application (and also in a paper published by HI, Efficiency Prediction Method for Centrifugal Pumps).

The HI standard includes algorithms that estimate achievable pump efficiencies based on pump style and operating conditions.

Beginning with PSAT2007, the user is also provided with the ability to specify an achievable efficiency (completely independent of the HI standard methodology). This may be used, for example, to estimate potential savings associated with use of a specific pump model, or restoration of a pump to like-new conditions. It can also be helpful in assessing opportunities in systems that require special purpose pumps that are not addressed by the HI standard methods, such as recessed impeller pumps.

- End suction ANSI/API ▼
- ✓ End suction slurry
- End suction sewage
- End suction stock
- API double suction
- Multistage boiler feed
- End suction ANSI/API
- Axial flow
- Double suction
- Vertical turbine
- Large end suction
- Specified optimal eff (below)

#### Achievable efficiency

The pump “Achievable efficiency” input is only displayed when the pump style is “Selected optimal eff (below)”.

Achievable efficiency 85.0

The input value would normally be the pump efficiency at the specified operating conditions (under the Field data section), as opposed to the best efficiency point flow rate.

### Pump rpm

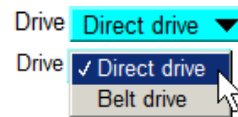
The operating or nameplate speed for the pump is used, along with the measured/required flow rate and head and number of stages, to calculate the pump specific speed. The specific speed is used to determine efficiency penalty associated with the particular pump application.

Pump rpm

(Note that in common use, specific speed for a particular pump applies to its best efficiency point.)

### Drive

This drop-down selection menu allows the user to define whether the fan is direct driven by the motor or belt-driven.



The average losses used are based on curves from Appendix L of AMCA Publication 203-90. Variations ranging from -1% to +2% of the average value for motor loads exceeding 10 hp are indicated by the AMCA curves.

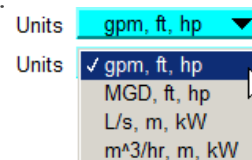
The reason that adjustable speed drives (ASDs) are not included here is twofold:

1. ASD efficiency is variable with speed. The user is referred to the PSAT workshop, which includes example ranges of combined motor and drive efficiencies for different drive types.
2. The current-based load estimation method employed by PSAT only applies to applications where the motor is driven directly across the line. Considerable variations in details associated with the drive and auxiliary component design render this method impractical.

If an adjustable speed drive is used, the user is cautioned to recognize that drive losses will inherently reduce the optimization rate, and artificially inflate the potential savings (assuming that the drive needs to remain in place).

### Units

System of units choices indicate units of flow, head, and shaft power



- gpm, ft, hp....U.S. gallons/minute, feet, horsepower
- MGD,ft,hp....U.S. million gallons/day, feet, horsepower
- L/s, m, kW....Liters/second, meters, kilowatts
- m<sup>3</sup>/hr, m, kW....cubic meters/hour, meters, kilowatts



### Kinematic viscosity (cS)

This is the kinematic viscosity of the fluid being pumped, in centistokes.

Kinematic viscosity (cS)

This is used, in conjunction with algorithms from ANSI/HI 1.3-2000 to estimate reductions in achievable efficiency associated with elevated fluid viscosity.

### Specific gravity

The fluid "specific gravity" is the ratio of the density of the fluid to water at standard conditions. It is used when calculating the fluid power at the specified pump flow rate and head conditions.

Specific gravity

### # stages

The number of pump "stages" is used to calculate pump specific speed.

# stages

### Fixed specific speed?

The pump configuration switch allows you to specify whether the pump speed and/or number of stages can be changed or must remain as currently specified.

Fixed specific speed?  NO  YES

If the configuration must remain constant (i.e. value = "YES"), the pump specific speed will be calculated, and an efficiency penalty will be applied if the calculated specific speed is outside of the optimal range.

If the pump speed or number of stages can be changed, select "NO", and the optimal efficiency value will be used (no specific speed penalty).

More information about specific speed and the efficiency effect (modeled using HI standard estimates) can be accessed using the "Background information" near the bottom of the panel. This is followed in succession by clicking the "Pump efficiency curves" and "See specific speed efficiency penalty plot" selections.

## 15.2.4. Motor section

<b>Motor</b>	Line freq.	<input type="text" value="60 Hz"/>
	HP	<input type="text" value="200"/>
	rpm	<input type="text" value="1780"/>
	Eff. class	<input type="text" value="Specified (below)"/>
	FL efficiency, %	<input type="text" value="95.8"/>
	Voltage	<input type="text" value="460"/>
	<input type="button" value="Estimate FLA"/>	
	Full-load amps	<input type="text" value="225.4"/>
	Size margin, %	<input type="text" value="0"/>

### Line frequency

Line frequency is the mains supply frequency; choices are 50 Hz and 60 Hz. The only use of this input is to determine the number of motor poles, based on the specified motor speed. PSAT uses algorithms based on the number of motor poles, along with efficiency class to establish the characteristic motor curves (efficiency, current, power factor vs. load).

Line freq. **50 Hz**

### Motor rated power (HP or kW)

The rated power is the nameplate (shaft output) power rating for the existing motor. Depending on the Units selected in the "Pump, fluid" section, the motor power rating will be either in horsepower (HP) or kilowatts (kW).

For the HP option, standard NEMA (MG-1) sizes from 5 hp and upwards will be available for selection. For the kW option, the preferred ratings from IEC 60072 are used up to 1000 kW. Above 1000 kW, the numerical values from the NEMA standard are used, simply because they reflect a reasonable span.

HP **200** kW **150**

HP	kW
5	11
7.5	13
10	15
15	18.5
20	22
25	26
30	30
40	37
50	45
60	55
75	75
100	90
125	110
150	132
✓ 200	✓ 150
250	160
300	185
350	200
400	225

### Motor rpm

The motor nameplate speed and the line frequency are used to determine the number of motor poles. This, in turn, is used (along with the motor class and size) to estimate motor efficiency and output shaft power for the measured electrical power or current conditions. These estimates are based on curve-fitting algorithms developed for PSAT using average performance of motors in the specified class from the MotorMaster+ database and (for larger motors) other published manufacturer data.

Motor rpm **1780**

### Motor Efficiency class

There are four basic efficiency classes of motors available in this menu list item: "Standard efficiency", "Energy efficient", "Average", and user "Specified". In all cases, the selection applies to the existing motor ONLY. For the optimal case, PSAT selects an energy-efficient motor (the user has no choice in the selection).

Eff. class **Standard efficiency**

- ✓ Standard efficiency
- Energy efficient
- Average
- Specified (below)

The motor classification is based on how the motor rated efficiency compares with the NEMA MG 1-2003, Table 12-11 standard. If at or above the Table 12-11 Nominal Efficiency, the Energy efficient classification applies; if below, the Standard efficiency classification should





be used. If unknown, the selection of Average results in the average of Standard efficiency and Energy efficient performance being used.

A value can also be specified if nameplate or other data sources are available to better inform the user.

The classification is used in estimating the motor efficiency and output power conditions for a given input power or current. It is also used to estimate full load current using the “Estimate FLA” button.

The performance of both HP- and kW-rated motors uses the same classification scheme, even though different standards apply. In the larger scheme of things for pumping systems, the differences are insignificant.

---

### Full Load (FL) efficiency, %

---

The Full Load efficiency input only appears if the Motor Efficiency class selection is "Specified (below)".

FL efficiency, %

In many respects, this is the preferred method for evaluating the existing operation, in that if the nameplate full load efficiency is available, it should provide a better reflection of the specific motor performance than would the values in the other three Motor Efficiency classifications, which are strictly based on the motor population statistical averages.

---

### Motor rated voltage

---

The nominal motor voltage is the motor design (nameplate) voltage. The Pumping System Assessment Tool develops load and efficiency estimates based on normalized characteristics for 460 volt rating from the MotorMaster+ database, supplemented by additional published data for large and slower speed motors from several motor manufacturers.

Voltage

Since the normalized performance of motors is minimally affected by rated voltage, the 460-volt characteristic motor performance curve shapes are used for all nominal voltages. Efficiency as a percent of load is held constant; average current is adjusted inversely to the ratio of voltage.

---

### Estimate Full Load Amps (FLA)

---

This button can be used to provide an estimate of full load amps (FLA) when nameplate information is not available. This estimate is based on average data for motors of the specified motor hp, class, voltage, and speed; hence those parameters must be selected before clicking this button. Motor data used in the algorithms was



normalized 460 volt; if another voltage is selected when the full load amps initialization button is depressed, the FLA shown will be adjusted in a linear, inverse fashion to the existing voltage. For example, the average FLA for four-pole, 460-volt, premium efficiency, 25 hp motors in the database is 30.0 amps.

If the specified Nominal motor voltage is 230 volts, clicking on the "FLA initialization" button will cause a value of  $(460/230) * 30.0 = 60.0$  amps to be used.

If the Nameplate FLA varies by more than 5% from the average FLA for the motor rated power, speed, voltage, and class, the Estimate button and the Nameplate FLA background color will turn yellow. This is a caution to the user that the FLA value is outside the expected range.

### Full-load amps

The nameplate "Full load amps (FLA) " is used as a normalizing value if "Current" is the selected load estimation method (see discussion in the Measured or required conditions section below).

Full-load amps

If the FLA is unknown, an estimate can be made by using the "Estimate" on the left. Note that the correct Nominal motor voltage, hp, and speed should be entered before the FLA initialization button is depressed.

If the Nameplate FLA varies by more than 5% from the average FLA for the motor rated power, speed, voltage, and class, the "Estimate" button and the Nameplate FLA background color will turn yellow. This is a caution to the user that the FLA value is outside the expected range.

### Size margin, %

This size margin is added to the motor selected for the optimal application. If 90 shaft hp is required for a pump operating optimally at the specified hydraulic conditions, and a 15% margin is specified, PSAT will assume that the motor rating will be the next size larger. As  $90 \times 1.15 = 103.5$ , a 125 hp motor would be selected. If a 10% margin had been specified, a 100 hp motor would have been selected, since  $90 \times 1.10 = 99$ .

Size margin, %

## 15.2.5. Duty, unit cost section

Duty, unit	Operating fraction	<input type="text" value="1.000"/>
cost	\$/kwhr	<input type="text" value="0.0500"/>

### Operating fraction

This is simply the fraction of the calendar hours that the equipment is operating at the specified conditions. It is used to calculate the annual cost results.

Operating fraction



### \$/kwhr (electric energy unit cost rate)

This is the per unit energy cost of electricity.

\$/kwhr

Demand charges, power factor-related penalties, and other issues can have a significant impact on the average per unit energy cost. Factors such as the time and amount of use, existing power factor, etc. would need to be considered in a detailed analysis.

For most purposes, the simplest approach is to divide the monthly (or preferably annual) electric energy cost by the corresponding period's energy consumption, both of which are normally included in electric bills.

### 15.2.6. Field data section

Field data	Flow rate, gpm	<input type="text" value="2000"/>
	Head tool	<input type="text" value="276.8"/>
	Head, ft	<input type="text" value="276.8"/>
	Load estim. method	<input type="text" value="Power"/>
	Motor kW	<input type="text" value="150.0"/>
	Voltage 2	<input type="text" value="460"/>

### Flow rate (gallons per minute, million gallons/day, Liters/second, or cubic meters/hour)

Either the measured or the required flow rate in units that are consistent with the selection in the "Pump, fluid" section above is input here.

Flow rate, gpm

Flow rate, MGD

The flow rate value is used by the software to calculate the fluid power, which in turn is used to estimate existing pump efficiency and the optimal pump operating efficiency.

Flow rate, m<sup>3</sup>/h

Flow rate, L/s

PSAT uses curve fit algorithms that extend beyond the HI curve limits, so efficiency estimates will be made for all entries. If the specified flow rate is outside of the HI standard range limits, the background color will turn orange as a caution to the user.

### Head (ft or m)

Either the measured or the required pump head in feet (or meters) is specified here.

Head, ft

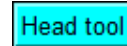
Head, m

Head, flow rate, and specific gravity are used to calculate fluid power for the existing condition. When combined with the estimated shaft power for the existing condition (which is based on the measured electrical data and the specified motor nameplate information), the existing pump efficiency can be determined.

To assist in calculating measured pump head, the "Head tool" button to the left of the head input box can be clicked to bring up a head calculation panel.

### Head tool button

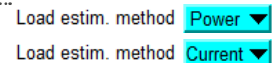
This button is used to access a pump head calculation panel where the user specifies measured pressure, elevation, flow rate, and line size data to calculate the head developed by the pump.



The head calculated in the routine can be returned to the primary panel (for the Condition from which the head calculator was selected), or canceled, leaving the primary panel unaffected.

### Load estimation method

There are two choices of Load estimation methods: "Power" and "Current"; both refer to the values at the motor input.

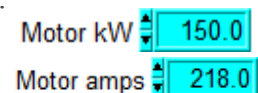


The preferred Load estimation method is power. If input power is accurately measured, the estimate of both pump and motor efficiencies will likely be more accurate than if current is measured alone.

If a power measurement is not practical, current can be used, along with algorithms built into PSAT, to estimate input power. The power estimate from current is made based on curve fits of the average motor current vs. load profile for the specified motor size, class, and speed. Experience has shown that for motors loaded to 50% of their rating or greater, the electrical power estimated by the PSAT current-based estimates will generally agree with actual power to within a few percent. However, for lightly loaded motors (e.g., 25% load), the error can be much greater. Fortunately, the vast majority of pump applications have motors that are loaded to greater than 50% of their rating.

### Motor kW or Motor amps

Either "Motor kW" (power) or "Motor amps" (current) will be displayed, depending on the load estimation method selected. Power is the preferred measurement, but unless a permanently installed power meter is available it is much more intrusive and challenging.



The measured current is needed if power cannot be measured. If possible, the value entered should be the average current among the three phases. Use of current to estimate input power or load is not ideal. As noted above, if current is used as the load estimation method, the measured current is compared to the average current vs. load and efficiency vs. load curves for the specified motor size, speed, and class to estimate the motor's electrical input and mechanical output powers.

The current estimating method should NOT be used if adjustable frequency drives are used. PSAT's algorithms are based on motor



performance for direct, across-the-line applications. Adjustable frequency drive power may be used, but the user should recognize that losses in the drive and increased losses in the motor are not accounted for by PSAT.

Another caution relative to current measurements: If power factor correction capacitors are in use, be sure the measured current is that to the motor, not to the combination of the motor and the capacitor bank (which will be lower than the motor current).

### Voltage

The measured bus Voltage is used, along with measured current, to estimate input motor power if current is the specified load estimation method. If power is the load estimation method, the current is estimated from power and voltage.

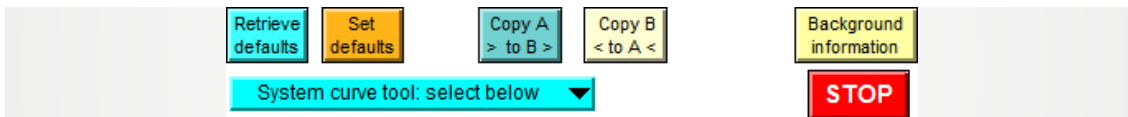


A simple algorithm based on a combination of sources is used to adjust for over/under voltage. The algorithm assumes that at 100% of rated load, current drops 1% for every 1% increase in voltage (or vice-versa at reduced voltage). At the other end of the load scale, no load, the algorithm assumes that current increases 1% for every 1% increase in voltage (and vice-versa at reduced voltage). The relationship is assumed linear with load, so that at 50% load, current is assumed to be unaffected by voltage.

It is recognized that such a simplistic algorithm cannot accurately capture response of all motors. Nevertheless, it is believed to be reasonably representative within the normal range of voltage deviation seen in industrial applications, and has been used with good success on a number of motors in actual field service.

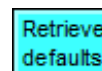
If there is greater than 10% between measured and nominal motor voltage, the measured Voltage box background color will change to yellow as a flag to alert the user to likely input error.

### 15.2.7. Common area controls



#### Retrieve defaults

Clicking this button will set the entire panel back to the default values, which the user can set using the button labeled "Set defaults". This arrangement allows the user to specify standard electrical cost rate data, facility and evaluator names, etc.



Note that another way of establishing multiple default values is to simply create a dedicated log (using the log file controls) and store different setups. This provides more flexibility but also involves additional steps.

---

### Set defaults

---

Clicking this button will make the currently displayed data the default configuration. The default configuration will automatically load each time PSAT is started. It can also be retrieved at any time by clicking the "Retrieve defaults" button to the left.



When the "Set defaults" button is clicked, the user will be prompted to verify that the default values are to be changed.

This arrangement allows the user to specify standard electrical cost rate data, units, facility and evaluator names, etc. that will be automatically loaded.

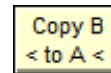
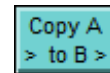
Note that another way of establishing multiple default values is to simply create a dedicated log (using the log file controls) and store different setups. This provides more flexibility, but also involves additional steps.

---

### Copy A to B, Copy B to A

---

These buttons are used to copy all of the data from "Condition A" to the "Condition B" (or vice-versa).



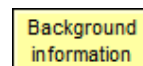
This includes supporting hidden data, including head calculation inputs and system curve data.

---

### Background information

---

This button is used to access background information about the operation of this software, motor, pump, system efficiency considerations and discussions of other points of interest relative to pumping system optimization, including distinguishing between measured and required conditions.



A prescreening section provides suggestions for activities and approaches to consider before spending the time and effort to acquire the data needed by PSAT.

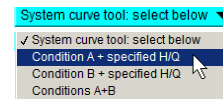
A link to a units-converter tool is also provided.

---



## System curve tool menu bar

For systems that deliver flow to a single location or to multiple locations with essentially identical, parallel paths, a system curve can be estimated from any two measured flow rate/head conditions (provided that the system configuration remains unchanged).



More information about system curve development can be found on the system curve panel, which is triggered by selecting any of the three options listed in the drop-down menu. For the first selection, "Condition A + specified H/Q", the head/flow data from Condition A will be transferred to the system curve panel where the user will need to enter another system head/flow point for the system curve to be drawn.

The same pattern tool applies to "Condition B + specified H/Q."

For the third entry, "Conditions A+B", the flow and head values from both entries will be used to construct the system curve with no additional information required from the user.

Obviously, the units will need to be consistent for proper curve development.

## STOP button

The "STOP" button can be used to temporarily suspend program calculations and updates. This may improve processor speed when the user wants to work in another application without quitting the PSAT application. Clicking on this button will stop the program updating but not quit the application.



Note that the "STOP" button only appears when the program is actively updating and will disappear after clicking, when a box alerting the user that "Calculation updating is off" replaces it.

To resume calculations, click on the arrow just below the Edit menu in the upper left corner of the screen.

The "STOP" button will reappear after clicking the arrow, reminding the user that the program is continuously updating calculated results.

The preferred method for exiting the PSAT programme is to first click the "STOP" button and then close the program by clicking on the standard window close button to the upper right.

### Calculation updating is off alert box

This is simply a status advisory noting that PSAT's calculations have been stopped. When this box is visible changes to inputs can be made, but the results will not be updated until clicking the arrow below the Edit menu restarts updating.

Calculation updating is off.  
Click the arrow below the edit menu to restart.

### Run arrow

PSAT's Run arrow appears just below the Edit menu. When PSAT calculation updating is live, the "STOP" button will be displayed and the run arrow will be black. If the "STOP" button is depressed, PSAT calculation updating will halt, the "Calculation updating is off" alert box will appear, and the Run arrow will change to white. To start PSAT running again, click on the white run arrow.



## 15.2.8. Results section

	Condition A			Condition B		
	Existing	Optimal	Units	Existing	Optimal	Units
Pump efficiency	72.6	84.8	%	72.5	85.0	%
Motor rated power	200	200	hp	150	132	kW
Motor shaft power	192.4	164.8	hp	143.8	122.7	kW
Pump shaft power	192.4	164.8	hp	143.8	122.7	kW
Motor efficiency	95.7	95.8	%	95.9	95.6	%
Motor power factor	86.7	85.7	%	86.4	86.4	%
Motor current	217.1	188.2	amps	217.9	186.4	amps
Motor power	150.0	128.4	kW	150.0	128.3	kW
Annual energy	1314.0	1125.1	MWh	1314.0	1124.1	MWh
Annual cost	65.7	56.3	\$1000	65.7	56.2	\$1000
Annual savings potential, \$1,000		9.4			9.5	
Optimization rating, %		85.6			85.5	

### Pump efficiency

- Existing

Existing pump efficiency is fluid power added by the pump divided by pump input shaft power.

Fluid power added by the pump is calculated from the product of the flow rate, head, and specific gravity. Shaft power is estimated using measured electrical data and PSAT's motor efficiency vs load curves.

- Optimal

Optimal pump efficiency is estimated based on the efficiency estimating algorithms contained in Hydraulic Institute Standard HI 1.3-2000, Centrifugal Pump Design and Application.

	Existing	Optimal	Units
Pump efficiency	72.6	84.8	%



The efficiency value used in PSAT includes the positive deviation from "generally attainable efficiency" shown in HI 1.3 Figures 1.76A and 1.76B.

### Motor rated power

- Existing

Existing motor nameplate power (same as Rated power in the Motor input section)

- Optimal

This is the nameplate motor rated power for an optimally sized pump.

PSAT uses the calculated fluid power and optimal pump efficiency to determine the optimal pump input shaft power. For a direct-driven pump, this is the same as the motor shaft power. If a belt drive is specified, belt losses are accounted for so the required motor shaft power will be greater.

The size margin specified in the Motor input section is added to the required motor shaft power. Using the resultant value, PSAT selects the next largest standard motor size.

	Existing	Optimal	Units
Motor rated power	200	200	hp

### Motor shaft power

- Existing

This is the estimated motor shaft power for the existing motor. The estimate is based on measured electrical data and the PSAT's efficiency estimate for the specified motor size, speed, and class.

- Optimal

This is the motor shaft power requirement for the optimal pump, based on the specified flow rate, head, and specific gravity values, along with the HI 1.3 achievable efficiency algorithms. If a belt drive is specified, associated losses are added to the pump shaft power to determine required motor power. For direct-driven pumps, the pump and motor shaft powers are the same.

	Existing	Optimal	Units
Motor shaft power	192.4	164.8	hp

### Pump shaft power

- Existing

This is the estimated pump shaft power for the existing motor. The estimate is the same as the motor shaft power (above) for direct-driven applications. For belt-driven applications, belt losses are deducted from the motor shaft power to determine pump shaft power.

- Optimal

This is the shaft power requirement for the optimal pump, based on the specified flow rate, head, and specific gravity values, along with the HI 1.3 achievable efficiency algorithms.

	Existing	Optimal	Units
Pump shaft power	192.4	164.8	hp



### Motor efficiency

- Existing

This is the estimated efficiency of the existing motor at the existing load.

	Existing	Optimal	Units
Motor efficiency	95.7	95.8	%

- Optimal

This is the estimated efficiency for an energy- efficient motor of the size indicated in the Optimal Motor rated power entry above when operating at the Optimal Motor shaft power (also indicated above).

### Motor power factor

- Existing

This is the estimated power factor for the existing motor at the existing load. It is based on the measured electrical data and the motor performance characteristic curves for the specified motor.

	Existing	Optimal	Units
Motor power factor	86.7	85.7	%

- Optimal

This is the estimated power factor for an energy-efficient motor of the size indicated in the Optimal Motor rated power entry above when operating at the optimal motor shaft power (also indicated above).

### Motor current

- Existing

This is the estimated or measured current for the existing motor at the existing load.

	Existing	Optimal	Units
Motor current	217.1	188.2	amps

- Optimal

This is the estimated current for an energy-efficient motor of the size indicated in the Optimal Motor rated power entry above when operating at the optimal motor shaft power (also indicated above).

### Motor power

- Existing

This is the estimated or measured electric power for the existing motor at the existing load.

	Existing	Optimal	Units
Motor power	150.0	128.4	kW

- Optimal

This is the estimated electric power for an energy-efficient motor of the size indicated in the Optimal Motor rated power entry above when operating at the optimal motor shaft power (also indicated above).

### Annual energy

- Existing

This is the annual energy consumption at the measured/estimated power level for the existing equipment when operated for the fraction of time indicated in the Operating fraction at left.

	Existing	Optimal	Units
Annual energy	1314.0	1125.1	MWh



• Optimal

This is the annual energy consumption for an optimized pump driven by an energy-efficient motor, based on the estimated Motor power (above) and on the fraction of time the pump is operated (see Operating fraction at left).

**Annual cost**

• Existing

This is the existing annual energy cost based on the product of the Existing annual energy consumption (above) and the unit operating cost (cents/kwhr) input.

	Existing	Optimal	Units
Annual cost	65.7	56.3	\$1000

• Optimal

This is the existing annual energy cost based on the product of the Optimal annual energy consumption (above) and the unit operating cost (cents/kwhr) input.

**Annual savings potential, \$1,000**

This is the potential annual savings, in thousands of dollars if the existing equipment was replaced with equipment that performed consistently with that indicated for the Optimal case above.

Annual savings potential, \$1,000	9.4
-----------------------------------	-----

It is the difference in the Annual cost for the Existing and Optimal cases.

**Optimization rating, %**

This is a measure of the overall rating of the existing pumping system efficiency relative to the optimal motor, optimal pump configuration, expressed as a percentage. A value of 100 means the existing system is equal to the optimal, while a value of 50 means the existing system is half as efficient as the optimal system.

Optimization rating, %	85.6
------------------------	------

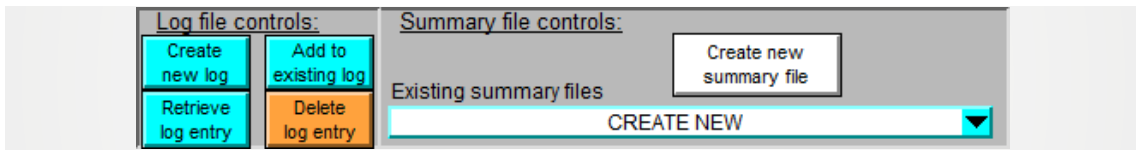
Mathematically, it is simply the Optimal Motor power divided by the Existing Motor power, expressed as a percentage.

It is possible for values of greater than 100% to exist, since the pump efficiencies used in the program reflect "generally attainable efficiency levels." There can be significant deviation in efficiency, particularly with smaller pumps (see Figure 1.63 of H1.3-2000).

The background color for the Optimization rating varies with the rating:

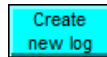
- >100: Dark Blue
- 90-100: Green
- 80-90: Olive
- 70-80: Yellow
- 60-70: Orange
- <60: Red

### 15.2.9. Log and summary files controls section



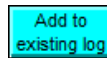
#### Create new log button

Click on this button to create a new data log with the existing information. The data will then be available for subsequent retrieval using the "Retrieve Log" button.



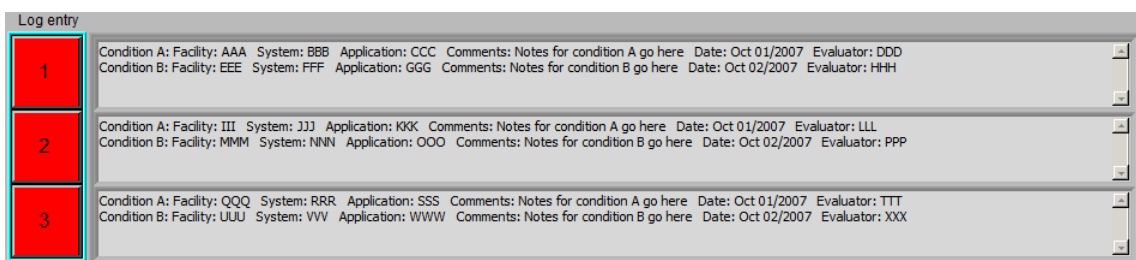
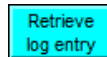
#### Add to existing log button

Click on this button to add the currently displayed data to an existing log file. You will be prompted to identify the log file to which the data will be added. Note: the file is not overwritten – it is supplemented with the currently displayed information. The data will then be available for subsequent retrieval using the "Retrieve Log" button.



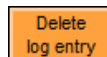
#### Retrieve log entry

Click on this button to retrieve previously logged data. You will be prompted to locate the file that the data is stored in. If there is more than one logged data set in the file, you will then see a listing of available logs from which to select, such as shown below. Click the numbered red button to the left of the text section, which includes information entered into the Documentation section. Adequate annotation of an analysis is important to the retrieval process.



#### Delete log entry

Click on this button to be prompted to select the log file from which a log entry will be deleted; once the file is selected, you will be shown all existing logs from which you can select one for deletion.

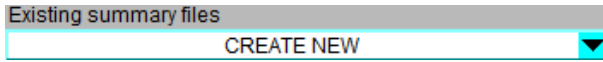
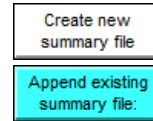


After deleting the log (or canceling log deletion), you'll be returned to this window and you can then repeat the sequence to delete a different entry.

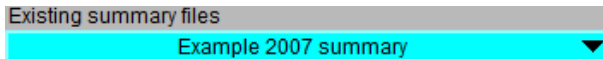


## Write summary file

The "Write summary file" button and "Existing summary files" drop down menu list are related chameleons, in that both have two different labels and colors. The label and color are dependent on the item selected in "Existing summary files".



If the Existing summary files menu selection is "CREATE NEW", the button will be labeled "Create new summary file", and the background color for both will be white. If any existing summary file is selected (such as "Example 2007 summary"), the button will be labeled "Append existing summary file", and the background color for both will be light blue.



If creating a new summary file, the user will be prompted to locate and name the file. The default location for summary files is in the "Summary files" folder, located in the PSAT main folder. Only summary files saved to this location will be displayed in the Existing summary files listing. Summary files can be saved elsewhere, but will not be available for appending.

A summary file is in a tab-delimited spreadsheet format. It can be opened with Excel or other spreadsheet program and it can also be opened with any text-editing or word processing program.

### 15.2.10. Documentation section

The documentation section includes several text boxes with relatively straightforward titles. The purpose of this section is, as the name implies, to simply record information that is useful in identifying the pumping system being evaluated, when the data was acquired, assumptions made, who did the analysis, etc. There is no requirement to complete any of the boxes, but if the analysis is to be logged for subsequent retrieval it is an excellent idea to complete this section.

Note that the General comments entry includes a scroll bar. This allows the user to provide as much information as is desired concerning assumptions, methods, circumstances, etc. as desired.

### 15.2.11. Pump head calculation panel: with suction and discharge pressure gauges

The pump head calculation panel provides two types of configurations to help the user calculate operating pump head. The configuration below is for situations where both suction and discharge pressure measurements can be made.

Type of measurement configuration  
Suction and discharge line pressures

$K_s$  represents all suction losses from gauge  $P_s$  to the pump  
 $K_d$  represents all discharge losses from the pump to gauge  $P_d$

Click to access units converter tool

Suction pipe diameter (ID) <input style="width: 80%;" type="text" value="12.000"/> inches	Discharge pipe diameter (ID) <input style="width: 80%;" type="text" value="10.000"/> inches
Suction gauge pressure ( $P_s$ ) <input style="width: 80%;" type="text" value="5.00"/> psig	Discharge gauge pressure ( $P_d$ ) <input style="width: 80%;" type="text" value="124.00"/> psig
Suction gauge elevation ( $Z_s$ ) <input style="width: 80%;" type="text" value="5.00"/> ft	Discharge gauge elevation ( $Z_d$ ) <input style="width: 80%;" type="text" value="5.00"/> ft
Suction line loss coefficients, $K_s$ <input style="width: 80%;" type="text" value="0.50"/>	Discharge line loss coefficients, $K_d$ <input style="width: 80%;" type="text" value="1.00"/>

Fluid specific gravity

Flow rate  gpm

Differential elevation head	0.00 ft
Differential pressure head	274.99 ft
Differential velocity head	0.54 ft
Estimated suction friction head	0.25 ft
Estimated discharge friction head	1.04 ft
<b>Pump head</b>	<b>276.81 ft</b>

Don't update

Click to leave the main panel head unchanged

Accept and update

Click to Accept and return the calculated head

System of units: gpm, ft, hp

**Important note about loss coefficients**

The loss coefficients used here apply to the velocity head in the line size represented by the suction and discharge pipe diameters at the points of pressure measurement.

If the loss elements are in different size lines than the points of pressure measurement, they need to be appropriately scaled. It is generally suggested that the losses be scaled in proportion to the 4th power of the diameter ratio. For example, if the discharge pressure is measured in a 12-inch header, and there is a 6-inch check valve with a nominal loss coefficient of 2 (applied to the 6-inch valve size), the K factor to use for the valve would be  $2 \times (12/6)$  to the 4th power, or 32. The reason for this 4th power scaling is that the velocity varies with the square of the pipe diameter, and the velocity head (to which the loss coefficients apply) is proportional to the velocity squared.





### 15.2.12. Pump head calculation panel: with suction tank elevation and discharge pressure

The configuration below is for situations where the suction pressure is not available, but suction tank (or well) level is.

Type of measurement configuration  
 Suction tank elevation, gas space pressure, and discharge line pressure

$K_s$  represents all suction losses from the tank to the pump  
 $K_d$  represents all discharge losses from the pump to gauge  $P_d$

Suction pipe diameter (ID)	12.000 inches	Discharge pipe diameter (ID)	10.000 inches
Suction tank gas overpressure ( $P_g$ )	0.00 psig	Discharge gauge pressure ( $P_d$ )	124.00 psig
Suction tank fluid surface elevation ( $Z_s$ )	10.00 ft	Discharge gauge elevation ( $Z_d$ )	5.00 ft
Suction line loss coefficients, $K_s$	0.50	Discharge line loss coefficients, $K_d$	1.00
Fluid specific gravity	1.000	Flow rate	2000.00 gpm

Differential elevation head	-5.00 ft
Differential pressure head	286.54 ft
Differential velocity head	1.04 ft
Estimated suction friction head	0.25 ft
Estimated discharge friction head	1.04 ft
Pump head	283.86 ft

System of units: gpm, ft, hp

**Important note about loss coefficients**  
 The loss coefficients used here apply to the velocity head in the line size represented by the suction and discharge pipe diameters at the points of pressure measurement.

If the loss elements are in different size lines than the points of pressure measurement, they need to be appropriately scaled. It is generally suggested that the losses be scaled in proportion to the 4th power of the diameter ratio. For example, if the discharge pressure is measured in a 12-inch header, and there is a 6-inch check valve with a nominal loss coefficient of 2 (applied to the 6-inch valve size), the K factor to use for the valve would be  $2 \times (12/6)$  to the 4th power, or 32. The reason for this 4th power scaling is that the velocity varies with the square of the pipe diameter, and the velocity head (to which the loss coefficients apply) is proportional to the velocity squared.

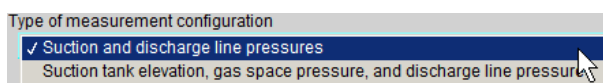
Descriptions of the individual controls and indicators on the head panel follow.

### 15.2.13. Pump head panel input data section

#### Type of measurement configuration

The popup menu near the top of the panel can make the selection of “measurement configuration”. The graphic underneath the menu changes to provide a graphical indication of the selected configuration, as illustrated below. Shown immediately below the graphic is the list of suction side inputs that correspond to the selected configuration.

If an input only appears under one of the two types of measurement configurations, it will be so noted in italics to the right of the heading in the **Input data section** descriptions that follow.



Type of measurement configuration  
Suction and discharge line pressures

$K_s$  represents all suction losses from gauge  $P_s$  to the pump  
 $K_d$  represents all discharge losses from the pump to gauge  $P_d$

Type of measurement configuration  
Suction tank elevation, gas space pressure, and discharge line pressure

$K_s$  represents all suction losses from the tank to the pump  
 $K_d$  represents all discharge losses from the pump to gauge  $P_d$

Suction pipe diameter (ID)	12.000	inches	
Suction gauge pressure ( $P_s$ )	5.000	psig	
Suction gauge elevation ( $Z_s$ )	5.000	ft	
Suction line loss coefficients, $K_s$	0.50		

Suction pipe diameter (ID)	12.000	inches	
Suction tank gas overpressure ( $P_g$ )	0.00	psig	
Suction tank fluid surface elevation ( $Z_s$ )	10.00	ft	
Suction line loss coefficients, $K_s$	0.50		

**Suction pipe diameter (ID)**

Suction pipe inside diameter in inches or mm. This is used to calculate the fluid velocity in the suction pipe, which in turn is used to determine the suction velocity head.

Suction pipe diameter (ID)  inches

**Suction gauge pressure ( $P_s$ )** – Suction and discharge line pressure configuration

Suction gauge pressure in psig or kPa

Suction gauge pressure ( $P_s$ )  psig

**Suction tank gas overpressure ( $P_g$ )** – Suction tank elevation, gas space pressure, and discharge line pressure configuration

This is the gas overpressure in the suction tank in psig or kPa. If the tank (or well, lake, etc.) is open to atmosphere, the gauge pressure should be set to 0.

Suction tank gas overpressure ( $P_g$ )  psig

**Suction gauge elevation ( $Z_s$ )** – Suction and discharge line pressure configuration

Suction gauge elevation in feet or meters, relative to a common reference point elevation.

This reference can be absolute (e.g. sea level), or relative (e.g. floor level). However, the same reference elevation must be used to define the discharge gauge elevation.

Suction gauge elevation ( $Z_s$ )  ft



**Suction tank fluid surface elevation (Zs)** – Suction tank elevation, gas space pressure, and discharge line pressure configuration

Suction tank fluid surface elevation (Zs) 10.00 ft

This is the elevation of the tank (or well, lake, etc.) relative to a common reference point elevation in either feet or meters.

This reference can be absolute (e.g. sea level), or relative (e.g. floor level). However, the same reference elevation must be used to define the discharge pressure gauge elevation.

**Suction line loss coefficients, Ks**

Suction line loss coefficients, Ks 0.50

The suction line loss coefficients are used to estimate the frictional head losses between the suction reference point (tank level or suction line pressure gauge) and the pump suction flange. Note that these coefficients apply to the Darcy-Weisbach style calculation ( $loss = K \times velocity\ head$ ).

These losses might come from elbows, tees, suction isolation valve, etc. and in the situation where the suction tank level is used as a reference, the entrance loss from the tank to the pipe.

IMPORTANT: All losses must be normalized to the specified suction pipe diameter, and loss coefficient adjustments are made to the 4th order of the pipe diameter ratio. For example, if there is a 12-inch isolation valve with a loss coefficient ( $K$ ) of 0.4, but the suction pipe diameter at the point where pressure is measured is 16-inches - such as in a suction header - the loss coefficient for the valve would be  $0.4 \times (16/12)^4$ , or 1.26.

Note: the fact that the word “coefficients” is plural is intentional – it is intended to account for the sum of all suction line loss elements.

**Discharge pipe diameter (ID)**

Discharge pipe diameter (ID) 10.000 inches

Discharge pipe inside diameter in inches or mm. This is used to calculate the fluid velocity in the discharge pipe, which in turn is used to determine the discharge velocity head.

**Discharge gauge pressure (Pd)**

Discharge gauge pressure (Pd) 124.00 psig

Discharge gauge pressure in psig or kPa





### Discharge gauge elevation (Zd)

Discharge gauge elevation in feet or meters, relative to a common reference point elevation.

Discharge gauge elevation (Zd)  ft

This reference can be absolute (e.g. sea level), or relative (e.g. floor level). However, the same reference elevation must be used in defining the suction gauge elevation.

### Discharge line loss coefficients, Kd

The discharge line loss coefficients value is used to estimate the frictional head losses between the pump discharge flange and the discharge pressure gauge. Note that these coefficients apply to the Darcy-Weisbach style calculation ( $loss = K \times velocity\ head$ ).

Discharge line loss coefficients, Kd

These losses might come from elbows, tees, discharge isolation valve, check valve, etc.

**IMPORTANT:** All losses must be normalized to the specified discharge pipe diameter, and loss coefficient adjustments are made to the 4th order of the pipe diameter ratio. For example, if there is an 8-inch swing check valve with a loss coefficient ( $K$ ) of 2, but the discharge pipe diameter at the point where pressure is measured is 16-inches - such as in a discharge header - the loss coefficient for the valve would be  $2 \times (16/8)^4$ , or 32.

Note: the fact that the word “coefficients” is plural is intentional – it is intended to account for the sum of all discharge line loss elements.

### Fluid specific gravity

Specific gravity of the fluid

Fluid specific gravity

Note: this value is brought over from the main PSAT panel. It can be changed here in the head calculator panel. If it is changed, the modified value will be returned along with the calculated head (if the “Click to Accept and return the calculated head” button is clicked).

### Flow rate

Pump flow rate in the indicated units (which are based on those selected on the main PSAT panel).

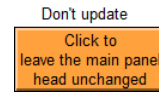
Flow rate  gpm

Note: this value is brought over from the main PSAT panel. It can be changed here in the head calculator panel. If it is changed, the modified value will be returned along with the calculated head (if the “Click to Accept and return the calculated head” button is clicked).



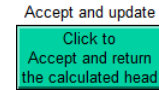
### Don't update button

Click this button to return to the main panel without updating the main panel flow rate, head, and specific gravity values.



### Accept and update button

Click this button to return the above specified flow rate and specific gravity values and the calculated head (right). The main panel will be updated to reflect these values. If the main panel is subsequently logged, all of the information on the head calculator panel (line sizes, gauge elevations, etc.) will be retained with the logged analysis.



### Differential elevation head

This is the difference in elevation between the suction and discharge reference points.

Differential elevation head  ft

In the case where a tank level is used, the elevation difference will be the elevation of the discharge pressure gauge minus the tank fluid surface elevation.

In the case where both suction and discharge gauges are used, the elevation difference will be the elevation of the discharge gauge minus the elevation of the suction gauge.

### Differential pressure head

The differential pressure head is the difference between the suction and discharge pressures, converted to units of feet or meters for the specified specific gravity.

Differential pressure head  ft

### Differential velocity head

The differential velocity head is the discharge velocity head minus the suction velocity head.

Differential velocity head  ft

$$\text{Velocity head} = V^2/2g$$

In the case where the suction tank level is used as a reference point, the differential velocity head will be identical to the discharge velocity head, as it is assumed that the tank is sufficiently large that the fluid velocity will be essentially zero.

If the suction and discharge line sizes are identical, the differential velocity head will be zero, as the velocity head in the two lines will be identical.

### Estimated suction friction head

This is an estimate of the friction losses in the suction line (from the suction reference point to the pump), based upon the calculated velocity head and the specified loss coefficients. The friction loss in feet or meters is:

Estimated suction friction head  ft

$$H_{fs} = K_s \times V^2 / 2g$$

### Estimated discharge friction head

This is an estimate of the friction losses in the discharge line (from the pump to the discharge gauge), based upon the calculated velocity head and the specified loss coefficients. The friction loss in feet or meters is:

Estimated discharge friction head  ft

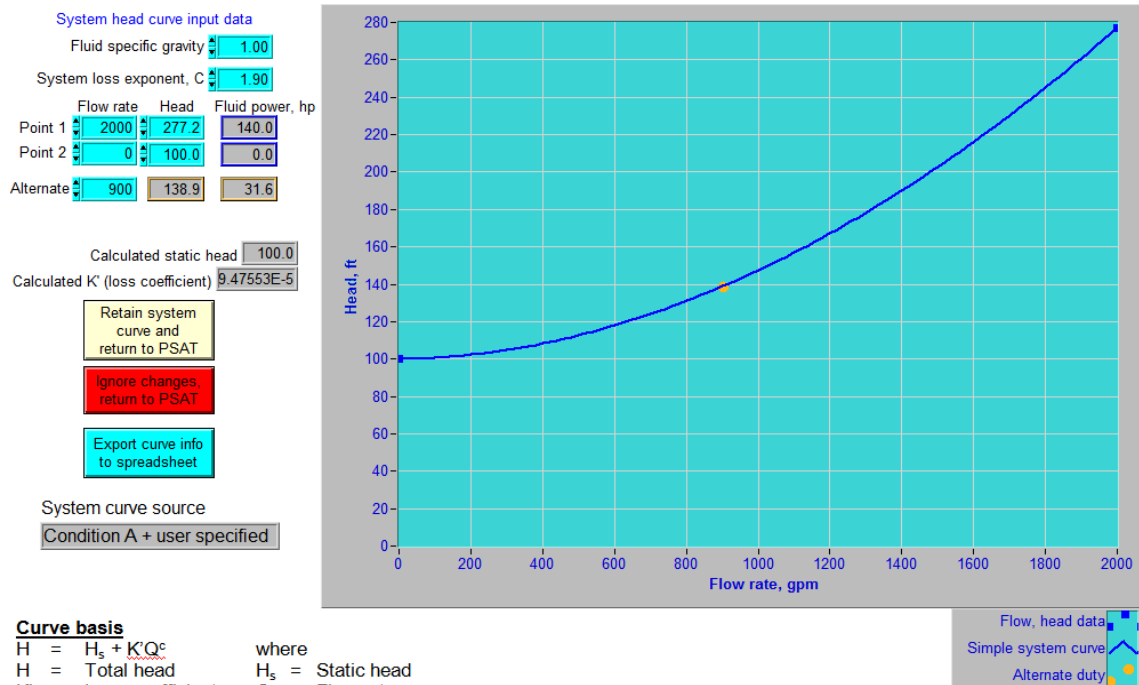
$$H_{fd} = K_d \times V^2 / 2g$$

### Pump head

This is the total pump head, including elevation, pressure, velocity components plus the estimated suction and discharge friction losses.

Pump head  ft

## 15.2.14. System curve panel





### 15.2.15. System curve element descriptions

#### Specific gravity

The "Fluid specific gravity" is initially set to the value specified on the main PSAT panel, but can be changed here.

Fluid specific gravity

The specific gravity does not affect the system head curve, but does affect the fluid power, which is directly proportional to the specific gravity.

#### System loss exponent, C

The system friction loss exponent is the exponent to which the flow rate is raised in developing friction loss estimates. While the Darcy-Weisbach equation, as applied to both pipe and fittings, indicates an exponent of 2 proportionality, the fact that the friction factor declines slightly with increasing Reynolds number causes the net effect to be slightly less than an exponent of 2.

System loss exponent, C

The difference is generally not significant. You might want to experiment with exponents ranging from 1.8 to 2.0 to see how the system head curve changes.

#### Point 1 conditions

The Point 1 flow rate and head values are initially specified based on data passed from the main PT panel. Depending upon which system curve source is used, the initial values will be:

	Flow rate	Head	Fluid power
Point 1	<input type="text" value="2000"/>	<input type="text" value="276.8"/>	<input type="text" value="139.8"/>

- Condition A + user specified: Condition A flow, Condition A head
- Condition B + user specified: Condition B flow, Condition B head
- Condition A + Condition B: Condition A flow, Condition A head

The fluid power for point 1 is calculated from the product of the flow rate, head, and specific gravity and is reported in either hp or kW, depending on the system of units from the main PSAT panel.

#### Point 2 conditions

If the Condition A + Condition B selection was made on the main PSAT panel, the flow rate shown here will be the value from Condition B. Otherwise, the user can specify another flow and head data pair to develop the system curve. In many cases this will be the system static head with the flow rate = 0.

	Flow rate	Head	Fluid power, hp
Point 2	<input type="text" value="0"/>	<input type="text" value="100.0"/>	<input type="text" value="0.0"/>



### Alternate duty point

To see the head for any flow rate on the system curve, type the flow rate value in the Alternate entry. The head for that point will be calculated from the system curve, displayed along side of it and marked on the curve (orange circle). The associated fluid power will also be displayed.

	Flow rate	Head	Fluid power, hp
Alternate:	900	138.9	31.6

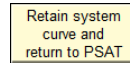
### System static head and K' loss coefficient

Both the system static head and the  $K'$  loss coefficient are determined from the combination of supplied Point 1 and Point 2 flow and head values, the loss exponent  $C$ , and the general curve characteristic  $H(Q) = H_s + K'Q^C$

Calculated static head	100.0
Calculated K' (loss coefficient)	9.47553E-5

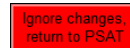
### Retain system curve button

Clicking this button will return the user to the main PSAT panel. It will also result in the curve data being retained in PSAT. If the main panel is subsequently logged, the system curve information will be stored within the log.



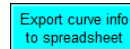
### Ignore changes button

Clicking this button will return the user to the main PSAT panel, but without modifying the system curve information.



### Export to spreadsheet button

This button is used to export the parameters needed to construct the curve (static head, the  $K'$  loss coefficient, and the System loss exponent  $C$ ) to a tab-delimited text file. This will allow the user to construct a system curve in a spreadsheet or other numerical processing program.



### System curve source indicator

This is an indicator that reports the selection made by the user on the main PSAT panel that led to this system curve panel.

System curve source	Condition A + user specified
---------------------	------------------------------





## Inconsistent flow units warning

---

### Mismatched units from main PSAT panel

**WARNING!** This panel will close in 5 seconds.

You elected to send the head and flow rate values from Condition and Condition B to this system curve panel, but the system of units for the two conditions were different. The systems of units for both conditions must be the same in order for the system curve to be meaningful.

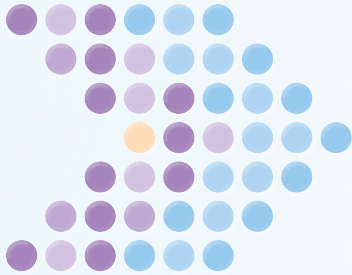
This warning appears when the user has called up the system curve panel with the Condition A + Condition B selection, but the systems of units used in the two conditions are different. A system curve is only valid if the pair of specified flow/head units are consistent. The entire system curve panel will automatically close, as noted, in 5 seconds after it is opened, taking the user back at the main PSAT panel.

---









UNIDO helps raise the business potential of industry by introducing and enhancing energy management practices and accounting methods. The present Manual for Industrial Pump Systems Assessment and Optimization seeks to provide direction and support to companies seeking to optimize their existing pump systems and serves as an additional knowledge resource for industrial energy efficiency service providers.



**TOGETHER**  
*for a sustainable future*

Vienna International Centre · P.O. Box 300 · 1400 Vienna · Austria  
Tel.: (+43-1) 26026-0 · [unido@unido.org](mailto:unido@unido.org)  
[www.unido.org](http://www.unido.org)