



**TOGETHER**  
*for a sustainable future*

## OCCASION

This publication has been made available to the public on the occasion of the 50<sup>th</sup> anniversary of the United Nations Industrial Development Organisation.



**TOGETHER**  
*for a sustainable future*

## DISCLAIMER

This document has been produced without formal United Nations editing. The designations employed and the presentation of the material in this document do not imply the expression of any opinion whatsoever on the part of the Secretariat of the United Nations Industrial Development Organization (UNIDO) concerning the legal status of any country, territory, city or area or of its authorities, or concerning the delimitation of its frontiers or boundaries, or its economic system or degree of development. Designations such as “developed”, “industrialized” and “developing” are intended for statistical convenience and do not necessarily express a judgment about the stage reached by a particular country or area in the development process. Mention of firm names or commercial products does not constitute an endorsement by UNIDO.

## FAIR USE POLICY

Any part of this publication may be quoted and referenced for educational and research purposes without additional permission from UNIDO. However, those who make use of quoting and referencing this publication are requested to follow the Fair Use Policy of giving due credit to UNIDO.

## CONTACT

Please contact [publications@unido.org](mailto:publications@unido.org) for further information concerning UNIDO publications.

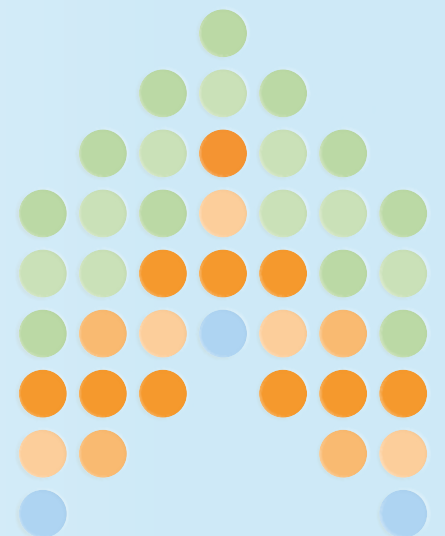
For more information about UNIDO, please visit us at [www.unido.org](http://www.unido.org)



**TOGETHER**  
*for a sustainable future*

1966 - 2016

# MANUAL FOR INDUSTRIAL STEAM SYSTEMS ASSESSMENT AND OPTIMIZATION



Copyright © United Nations Industrial Development Organization, 2016

This publication and any part thereof may be freely quoted and reprinted in any form for educational or non-profit purposes without special permission from the copyright holder, but acknowledgement of the source is requested. UNIDO would appreciate receiving a copy of any publication containing quotation or reprint.

No use of this publication may be made for resale or for any other commercial purpose whatsoever without prior permission in writing from the United Nations Industrial Development Organization.

Although great care has been taken to maintain the accuracy of information within this *Manual*, neither UNIDO nor the authors or contributors assume any legal liability or responsibility for consequences which may arise from the use of the *Manual*.

Reference herein to any specific commercial product, process, or service by trade name, trademark, manufacturer, or otherwise, does not necessarily constitute or imply its endorsement or recommendation by UNIDO. The views and opinions of authors expressed herein do not necessarily state or reflect those of UNIDO.



## FOREWORD

---

Energy is a fundamental prerequisite for development and economic activity. It is evident, however, that current energy supply and consumption patterns are environmentally unsustainable and must be improved. UNIDO's mandate to promote Inclusive and Sustainable Industrial Development (ISID) aims, inter alia, at decoupling industrial development from unsustainable resource usage and negative environmental impacts. Through ISID, UNIDO is also aligned with the Sustainable Development Goals (SDGs) – including SDG 9 (“Build resilient infrastructure, promote inclusive and sustainable industrialization, and foster innovation”) and SDG 7 (“Ensure access to affordable, reliable, sustainable and modern energy for all”).



As the developing world gradually embarks on industrial growth and participation in global trade, rising energy costs and the foreseen sizeable increase in energy demand make energy efficiency a definite priority. On the one hand, energy efficiency makes good business sense, as it entails cost savings and improvements by optimizing the use of resources and reducing waste. On the other hand, energy efficiency contributes to mitigating the negative impact of energy use and consumption on the environment, both at local and global level; a more resource-conscious approach allows more to be done with less. Among further benefits, energy efficiency leads to improved energy performance, increased operational reliability, strengthened security of supply, and reduced energy price volatility.

Industry is responsible for about a third of global CO<sub>2</sub> emissions. If the world is to meet the climate change mitigation goals set by the international community, industry needs to substantially increase its energy efficiency, and progressively switch to low-carbon and low-emission technologies, including renewable sources of energy.

UNIDO provides a variety of tools to address the immediate challenge of implementing the best available policies, technologies and practices for industrial energy efficiency through knowledge sharing, capacity building, demonstrations, investments and partnerships. UNIDO helps raise the business potential of industry by introducing and enhancing energy management practices and accounting methods. The present Manual for Industrial Steam Systems Assessment and Optimization is intended to provide guidance on energy systems assessment and optimization. Specifically, it seeks to provide direction and support to companies seeking to assess and optimize their existing steam systems, and an additional knowledge resource for industrial energy efficiency service providers.

**LI Yong**  
**Director General**

## ACKNOWLEDGMENTS

---

This publication was prepared by the UNIDO Industrial Energy Efficiency Division with the financial contribution of the State Secretariat for Economic Affairs of the Swiss Confederation (SECO), the Department for International Development (DFID) of the Government of the United Kingdom, the Department of Energy and the Department of Trade and Industry of the Republic of South Africa and the Global Environment Facility (GEF).

Marco Matteini was the project lead and had the overall responsibility for the design and development of this publication. Pradeep Monga, Director of UNIDO Energy Department, provided essential leadership and inspiration during the whole project.

This Manual for Industrial Steam Systems Assessment and Optimization was authored by Riyaz Papar, Hudson Technologies Company; Greg Harrell, Energy Management Services; and Ven Venkatesan, VGA Engineering Consultants Inc. Several individuals, industrial plants, government agencies and programs contributed significantly and committed valuable resources, time and effort to the development of this Manual. UNIDO and the authors express their sincere gratitude to all of them and give special mention to: the Industrial Technologies Program - Steam Best Practices of the US Department of Energy; Senthil Kumar, Hudson Technologies Company; Chrysler Corporation; Del Monte Foods – Modesto Plant; Jim Munch Process Systems and Energy Concepts Company.

The Manual has been peer reviewed by Rainer Stifter, Energon GmbH; Helmut Berger, ALLPLAN GmbH; and Giorgio Bocci, D'Appolonia Spa.

Special thanks go to Khac Tiep Nguyen, James New, Bettina Schreck, Sanjaya Shrestha and Rana Ghoneim from the UNIDO Industrial Energy Efficiency Division for their valuable inputs and support during the entire development process. The authors and project lead would also like to thank Oksana Pavliska and Egbert Mentzingen for editing the manuscript and providing constant support with regards to its preparation.



## ABOUT UNIDO

---

The United Nations Industrial Development Organization (UNIDO) is a specialized agency of the United Nations. Its mandate is to promote and accelerate sustainable industrial development in developing countries and economies in transition, and work towards improving living conditions in the world's poorest countries by drawing on its combined global resources and expertise. Since the 2013 Lima Declaration, UNIDO has embarked on a new vision towards Inclusive and Sustainable Industrial Development (ISID) with the purpose of creating shared prosperity for all as well as safeguarding the environment. Furthermore, through ISID, UNIDO addresses all three dimensions of sustainable development: social equality, economic growth and environmental protection. As a result, UNIDO has assumed an enhanced role in the global development agenda by focusing its activities on poverty reduction, inclusive globalization and environmental sustainability.

UNIDO services are based on two core functions: as a global forum, it generates and disseminates industry-related knowledge; as a technical co-operation agency, it provides technical support and implements projects.

UNIDO focuses on three main programmatic areas in which it seeks to achieve long-term impact:

- Advancing economic competitiveness
- Creating shared prosperity
- Safeguarding the environment

### About UNIDO Industrial Energy Efficiency

The UNIDO Industrial Energy Efficiency (IEE) Programme builds on more than three decades of experience and unique expertise in the field of industrial development and technology transfer. It represents a pillar of the Green Industry model that UNIDO promotes. Combining the provision of policy and normative development support services and capacity building for all market players, UNIDO aims at removing the key barriers to energy efficiency improvement in industries and ultimately transforming the market for industrial energy efficiency.

The UNIDO IEE Programme is structured around the following thematic areas:

- Policies and standards – strengthening policy and regulatory frameworks for more sustainable and efficient energy performance in industry;
- Energy management and efficient operation – integrating energy efficiency in day-to-day operations to save energy and reduce GHG emissions;
- Energy efficiency design and manufacturing – accelerating the adoption of new technologies and best practices.

## About the UNIDO Steam Systems Optimization (SSO) Programme

The UNIDO Steam Systems Optimization (SSO) Capacity Building and Implementation Programme consists of three elements: EXPERT Training, USER Training and a VENDOR Workshop.

The **SSO USER Training** is targeted at facility engineers, operators and maintenance staff of enterprises, equipment vendors and service providers and it is designed to instruct in how to assess industrial steam systems, identify opportunities for performance improvements and achieve energy/cost savings through proper operation and controls, system maintenance, and appropriate uses of steam.

The **SSO EXPERT Training** is intensive training delivered by leading international Steam Systems Optimization experts to national energy efficiency experts, service providers, equipment vendors and industry engineers. This training provides more in-depth technical information on assessing performance, troubleshooting and making improvements to industrial steam systems. This training also introduces basic principles for energy efficient design of steam systems and how to successfully sell steam systems improvement projects to management. National EE experts are trained in the classroom, on-the-job and through coaching by international SSO experts and are equipped with the expertise, skills and tools (including measuring equipment) required for providing the following services:

- Technical assistance to enterprises on steam systems energy assessment and identification, development and implementation of optimization projects
- Conducting SSO USER training and coaching facility personnel for steam systems energy assessment and optimization

The **SSO VENDOR Workshop** is targeted at local steam equipment vendors, suppliers and manufacturers. The workshop is designed to introduce these key market players to SSO techniques and service offerings. The objectives are to:

- Prepare manufacturers, vendors and suppliers to participate in reinforcing the system optimization message of the UNIDO project with their industrial customers;
- Assist manufacturers, vendors and suppliers in identifying what will be required to reshape their market offerings to include or reflect a system services approach.

The articulated process built and managed by UNIDO within its SSO Capacity Building and Implementation Programme is the joint effort and partnership of international leading specialists, national energy efficiency service providers and forward-looking industrial enterprises coming together to deliver tangible energy, environmental and economic results while creating business and market opportunities for sustainable steam systems optimization in industry and climate change mitigation. Fig A shows below the structure and standard schedule of the UNIDO SSO EXPERT training programme.

The present Manual is one of the knowledge and training resources used during the UNIDO SSO Programme and is made available to participants of the USER and EXPERT trainings.

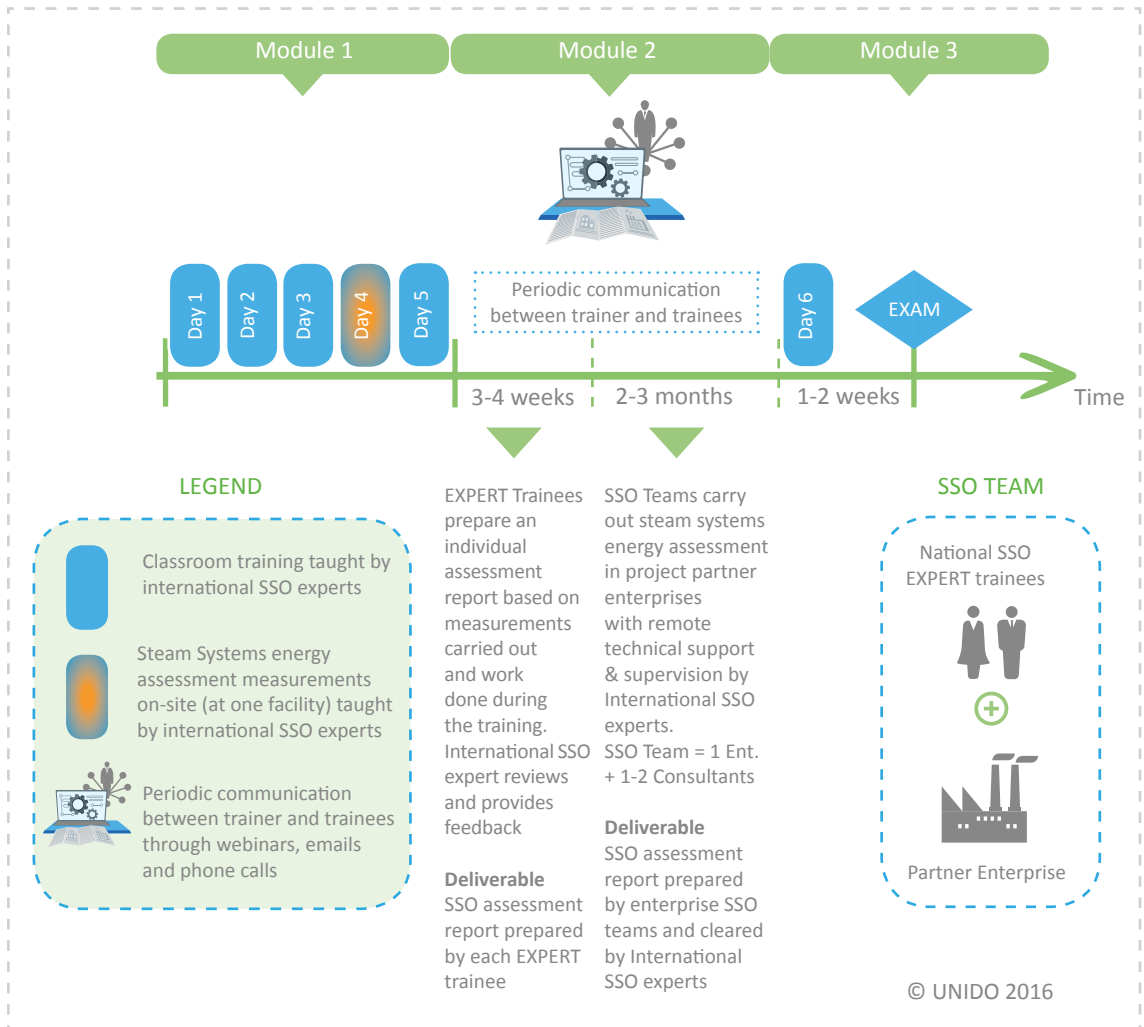


Fig. A. Structure of the UNIDO Steam Systems Optimization EXPERT training programme



# TABLE OF CONTENTS

---

<b>FOREWORD</b> .....	<b>3</b>
<b>ACKNOWLEDGMENTS</b> .....	<b>4</b>
<b>ABOUT UNIDO</b> .....	<b>5</b>
About UNIDO Industrial Energy Efficiency .....	5
About the UNIDO Steam Systems Optimization (SSO) Programme.....	6
<b>TABLE OF CONTENTS</b> .....	<b>8</b>
List of Figures.....	10
List of Tables .....	11
<b>ABOUT THE MANUAL</b> .....	<b>13</b>
<b>NOMENCLATURE</b> .....	<b>14</b>
<b>1. INTRODUCTION</b> .....	<b>16</b>
1.1. Industrial Steam Users.....	16
1.2. Advantages of Using Steam .....	17
1.3. The Systems Approach .....	17
<b>2. FUNDAMENTALS OF STEAM SYSTEMS</b> .....	<b>18</b>
2.1. Generic Steam Systems and Components .....	18
2.2. Steam System Line Diagrams .....	20
2.3. Steam Thermodynamics .....	22
2.4. Fundamental Laws & Principles .....	24
<b>3. SCOPING THE INDUSTRIAL STEAM SYSTEM</b> .....	<b>25</b>
3.1. US DOE’s Steam System Scoping Tool (SSST) .....	25
<b>4. MODELING THE INDUSTRIAL STEAM SYSTEM</b> .....	<b>27</b>
4.1. US DOE’s Steam System Assessment Tool (SSAT) .....	28
4.2. Steam Systems Optimization Projects in SSAT .....	30
<b>5. STEAM GENERATION OPTIMIZATION OPPORTUNITIES</b> .....	<b>32</b>
5.1. Fuel Properties.....	32
5.2. Steam Generation Cost.....	33
5.3. Boiler Efficiency Calculation (Direct Method).....	34
5.4. Boiler Efficiency Calculation (Indirect Method).....	35
5.5. Steam Generation Optimization Opportunities & BestPractices .....	44
<b>6. STEAM DISTRIBUTION OPTIMIZATION OPPORTUNITIES</b> .....	<b>57</b>
6.1. Overview .....	57
6.2. Steam Distribution Optimization Opportunities & BestPractices .....	58
<b>7. STEAM END-USE OPTIMIZATION OPPORTUNITIES</b> .....	<b>68</b>
7.1. Steam Balance Overview .....	68
7.2. Steam End-Use Optimization Opportunities & BestPractices .....	72
<b>8. STEAM CONDENSATE RECOVERY OPTIMIZATION OPPORTUNITIES</b> .....	<b>74</b>
8.1. Overview .....	74
8.2. Steam Traps .....	75
8.3. Condensate Recovery Optimization Opportunities & BestPractices .....	79
<b>9. COMBINED HEAT &amp; POWER (CHP) OPTIMIZATION OPPORTUNITIES</b> .....	<b>86</b>
9.1. Overview .....	86
9.2. Steam Turbines .....	87



9.3. Steam Turbine Efficiency.....	89
9.4. Steam Rate .....	91
9.5. CHP Optimization Opportunities & BestPractices .....	91
<b>10. STEAM SYSTEM ASSESSMENT PROTOCOL .....</b>	<b>97</b>
10.1. Industrial Energy Assessments.....	97
10.2. Steam System Industrial Energy Assessment Standard .....	98
10.3. Typical Project Areas in a Steam System Energy Assessment .....	99
10.4. Energy Savings Opportunities .....	100
<b>11. PORTABLE INSTRUMENTS FOR AN INDUSTRIAL STEAM SYSTEM ASSESSMENT.....</b>	<b>101</b>
11.1. Data Collection for Industrial Steam System Assessments.....	101
11.2. Portable Instrumentation .....	102
<b>12. STEAM SYSTEM ASSESSMENT REPORT.....</b>	<b>110</b>
12.1. Steam System Assessment Wrap-Up Meeting .....	110
12.2. Steam System Assessment Final Report .....	111
<b>13. CASE STUDIES .....</b>	<b>123</b>
13.1. Case Study #1 – DOW Chemical Company.....	124
13.2. Case Study #2 – Chrysler Corporation .....	126
13.3. Case Study #3 – Terra Nitrogen Company, L.P.....	129
13.4. Case Study #4 – Del Monte Foods Company .....	132
13.5. Case Study #5 – Recover Condensate from Evaporator Paste Sterilizers .....	133
13.6. Case Study #6 – Steam/Electric Drive Optimization in a Refinery.....	135
13.7. Case Study #7 – Better utilization of Steam’s superheat .....	138
13.8. Case Study #8 – Waste Heat Utilization and Heat Integration .....	139
<b>14. CONCLUSIONS &amp; NEXT STEPS .....</b>	<b>142</b>
14.1. Steam Systems Optimization Opportunities & BestPractices.....	142
14.2. Steam System Assessment Standard .....	144
14.3. Data Collection & Portable Instrumentation.....	144
14.4. Steam System Assessment Report .....	145
14.5. Next Steps .....	145
<b>15. REFERENCES .....</b>	<b>146</b>
<b>APPENDIX A: STEAM TABLES (FROM REFPROP) .....</b>	<b>147</b>
A.1 Saturated Liquid and Vapor Properties (by Pressure) .....	147
A.2 Saturated Liquid and Vapor Properties (by Temperature).....	152
A.3 Superheated Vapor Properties (by Pressure) .....	153
A.4 Subcooled Liquid Properties (by Pressure).....	155
<b>APPENDIX B: STACK LOSS TABLES .....</b>	<b>156</b>
B.1 Fuel Composition.....	156
B.2 Stack Loss for Natural Gas .....	157
B.3 Stack Loss for #2 Fuel Oil .....	157
B.4 Stack Loss for #6 Fuel Oil.....	158
B.5 Stack Loss for Bituminous Coal (Water – 4%; Ash – 7%).....	158
B.6 Stack Loss for Bituminous Coal (Water – 5%; Ash – 35%).....	159
B.7 Stack Loss for Bituminous Coal (Water – 10%; Ash – 15%) .....	159
B.8 Stack Loss for Green Wood .....	160

## List of Figures

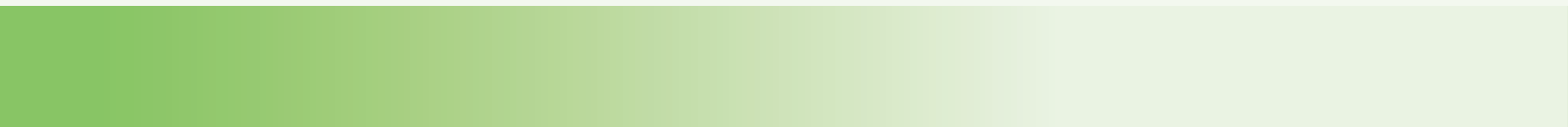
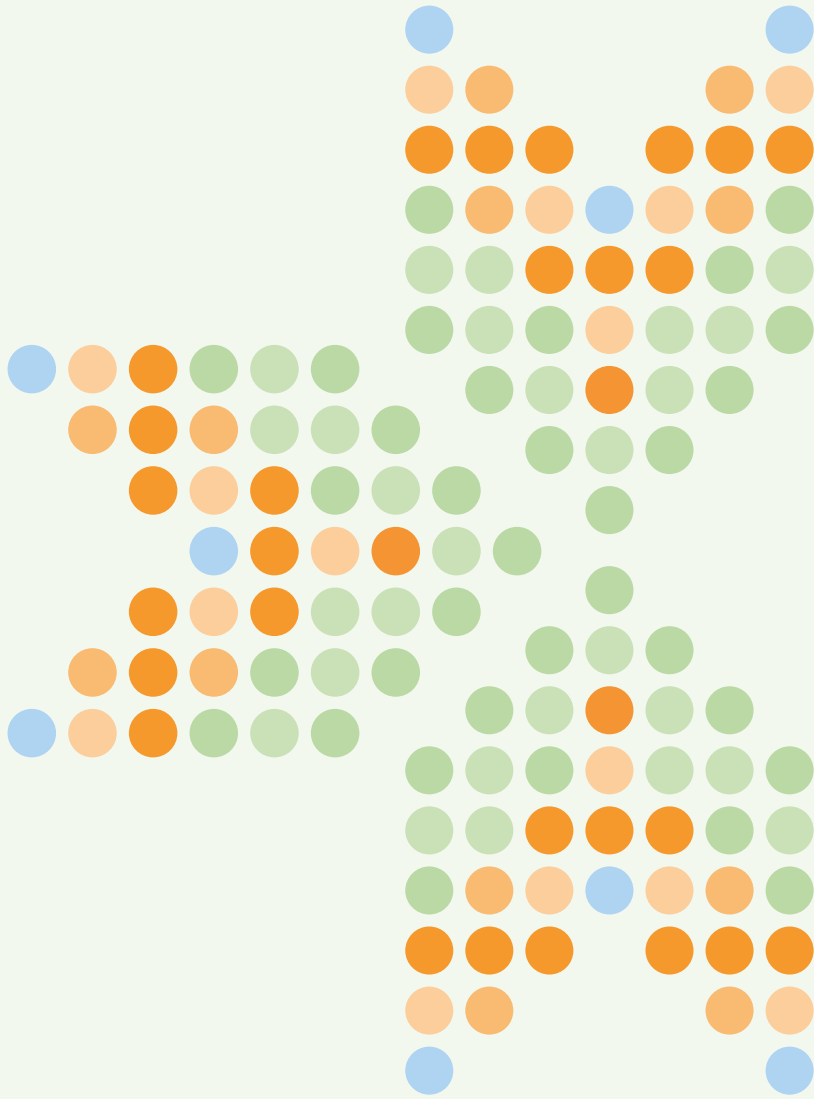
Figure 1: Generic Steam System.....	18
Figure 2a: A 1-Pressure Header Steam System Line Diagram .....	20
Figure 2b: A 2-Pressure Header Steam System Line Diagram.....	21
Figure 2c: A 3-Pressure Header Steam System Line Diagram .....	21
Figure 2d: A 3-Pressure Header w/Condensing Turbine Steam System Line Diagram .....	22
Figure 3: Saturation Temperature – Pressure Relationship for Steam.....	23
Figure 4: Mollier Diagram (Steam) .....	24
Figure 5a: SSAT “1-Header” Steam System Model .....	28
Figure 5b: SSAT “2-Header” Steam System Model.....	29
Figure 5c: SSAT “3-Header” Steam System Model .....	29
Figure 6: SSAT “3-Header” Steam System Model “Results” Page.....	31
Figure 7: Typical Natural Gas Fired Boiler Efficiency Curve .....	34
Figure 8: Operating Boiler Losses.....	35
Figure 9: Boiler Blowdown Thermal Energy Content .....	40
Figure 10: Stack Loss Calculator in US DOE SSAT Software .....	42
Figure 11: Example Boiler – Stack Loss .....	43
Figure 12: Positioning Control System.....	45
Figure 13: Automatic Oxygen Trim Control System .....	46
Figure 14: Example Boiler – Stack Loss Calculation with Feedwater Economizer .....	50
Figure 15: Automatic Boiler Blowdown Controller.....	52
Figure 16: Blowdown Energy Recovery .....	53
Figure 17: Steam Leakage Rate through an Orifice.....	59
Figure 18: 3EPlus® Input Screen.....	63
Figure 19: 3EPlus® Results Screen.....	63
Figure 20: A Typical Steam End Use Pie Chart for a Food and Beverage Industry.....	69
Figure 21: Steam / Water Indirect Heat Exchange .....	70
Figure 22: Steam / Water Direct Heat Exchange .....	71
Figure 23: Steam Coil Air Heater (Current Operation).....	72
Figure 24: Functioning of Thermostatic Steam Trap .....	76
Figure 25: Functioning of F&T Mechanical Steam Trap .....	77
Figure 26: Functioning of Inverted Bucket Mechanical Steam Trap .....	77
Figure 27: Functioning of Disk-type Thermodynamic Steam Trap .....	78
Figure 28: Functioning of Orifice type Steam Traps.....	79
Figure 29: Condensate Return System .....	82
Figure 30: Flashing High Pressure Condensate to make Low Pressure Steam.....	85
Figure 31: BackPressure Steam Turbines.....	88
Figure 32: BackPressure Extraction Steam Turbine.....	88
Figure 33: Condensing Turbine .....	89
Figure 34: Steam Rate and Steam Turbine Efficiency.....	91
Figure 35: Current Operation at Industrial Plant using PRV .....	92
Figure 36: CHP Configuration at Industrial Plant using Steam Turbine .....	93
Figure 37: Using Thermal Imaging Camera in a Steam System Assessment.....	104



Figure 38: Thermal Images captured during a Steam System Assessment ..... 104  
Figure 39: Pitot Tubes (and Digital Manometer) used in a Steam System Assessment ..... 105  
Figure 40: Use of Stack Gas Analyzers in a Steam System Assessment..... 107  
Figure 41: Portable Power meter for use in a Steam System Assessment ..... 107  
Figure 42: Example – Steam Turbine Operating Efficiency Curve .....115  
Figure 43: Example – Steam System Model .....115  
Figure 44: Steam Turbine Driven Screw Chiller ..... 133  
Figure 45: Evaporator Paste Sterilizer ..... 134  
Figure 46: Process Flow Schematic of Original Evaporator Paste Sterilizer System ..... 134  
Figure 47: Process Flow Schematic of Improved Evaporator Paste Sterilizer System ..... 135  
Figure 48: Steam System Balance Diagram at the Refinery..... 136  
Figure 49: Operating Cost Impact & Optimization for ERC at the Refinery ..... 137  
Figure 50: Observed Turbine Operation at the Plant ..... 138  
Figure 51: Turbine Operation modified without Desuperheater ..... 139  
Figure 52: Heat Rejection at Cooling Tower and Heat addition at Deaerator ..... 140  
Figure 53: Heat Integration by recovering the rejected heat at the Cooling Tower ..... 140

**List of Tables**

Table 1: SSST “Summary of Results” for an Average Industrial Steam System .....26  
Table 2: Higher Heating Values of Common Fuels ..... 33  
Table 3: First Order Shell Loss Guide.....36  
Table 4: Stack Loss Table for Natural Gas .....42  
Table 5: Flue Gas Control Parameters.....46  
Table 6: Parametric Analysis for a BackPressure Steam Turbine CHP Optimization Opportunity ....94  
Table 7: Parametric Analysis for a Condensing Turbine CHP Optimization Opportunity..... 95  
Table 8: Categories of Energy Savings Opportunities ..... 100  
Table 9: Introduction Information in a Steam System Assessment Report .....112  
Table 10: Example – Summary Table of Energy Optimization Opportunities..... 113  
Table 11: Example – List of Qualitative Recommendation..... 113  
Table 12: Example – Energy Optimization Opportunity Write-up .....119  
Table 13: Example – Energy Optimization Opportunity Write-up ..... 120  
Table 14: Example – Energy Optimization Opportunity Write-up .....121  
Table 15: Examples of Qualitative Recommendations Write-up..... 122  
Table 16: Steam Turbine Drives on Rotating Equipment in UK Refinery ..... 137





## ABOUT THE MANUAL

---

This Manual for Industrial Steam Systems Assessment and Optimization (hereinafter simply referred to as Manual) is an integral part of the knowledge resources and tools of the UNIDO Capacity Building and Implementation Program on Industrial Steam Systems Optimization and it is meant to complement and reinforce classrooms and on-site plant training. The Manual DOES NOT replace the classroom and onsite instructor-led training.

The Manual is used to teach end-users and energy consultants how to assess and optimize steam systems. Its primary purpose is to help identify, quantify and achieve energy and cost savings through proper operation and controls, system maintenance, appropriate process uses of steam and application of state-of-the-art technologies in an industrial steam system.

The Manual covers the operation of typical industrial steam systems that include steam generation; steam distribution; steam end-uses; condensate recovery and combined heat and power (CHP). It then describes each of the areas in detail and identifies critical and important parameters, measurements, etc. that are required to undertake a “System Approach” based steam system energy assessment at a plant. It identifies performance improvement opportunities in each of the above-mentioned areas that lead to the optimization of the overall steam system.

The Manual also provides information on how to conduct a steam system energy assessment following a standard protocol and a template for reporting assessment findings and recommendations. The Manual includes information on the portable instrumentation that is typically required and used during a steam energy system assessment. Lastly, a few case studies on successful projects implemented in the industry are also presented to help the expert understand the assessment methodology and successful implementation.

All steam system level analysis should obey the fundamental laws of physics and thermodynamics (heat and mass balance). Typically, it is not easy to conduct detailed analysis manually and the expert needs to model these applications using software based tools. The use of software tools is becoming very prevalent with industry having “real-time” Data Acquisition Systems and dashboards in their control rooms for steam system models and analysis. Any methodology used for steam system analysis should realize the “System Approach” and be based on sound engineering principles. The Manual and UNIDO’s Industrial SSO Programme make reference to and use of the Steam Systems Best Practices software tools suite developed by the US Department of Energy, which allows for modeling of industrial steam systems. Moreover, it allows for the quantifying of both energy and cost savings from projects and provides an excellent platform for the steam system user. The Manual introduces these software tools and provides information on where to get them online.

Overall, this Manual provides an easy to understand methodology for steam system users and experts, guiding them through a meticulous/detailed “System Approach” with the goal of optimizing industrial steam systems performance. In addition, this manual provides the steam system users and experts with simple examples and sample problems to test their knowledge as they progress through the different sections in an industrial steam system.

## NOMENCLATURE

---

$A_{orifice}$	area of orifice
$C_p$	specific heat
$d_{orifice}$	diameter of orifice
$h_{blowdown}$	enthalpy of blowdown stream
$h_{condensate}$	enthalpy of condensate returned
$h_{exit}$	enthalpy at turbine exit
$h_{feedwater}$	enthalpy of feedwater
$H_{HVfuel}$	Higher Heating Value of fuel
$h_{inlet}$	enthalpy at turbine inlet
$h_{makeup}$	enthalpy of make up water
$h_{PRV}$	enthalpy at PRV exit
$h_{steam}$	enthalpy of steam
$h_{water\_in}$	enthalpy of water into a vessel
$h_{water\_out}$	enthalpy of water out of a vessel
$K_{bd\_savings}$	blowdown reduction fuel energy cost savings
$K_{bd\_system}$	fuel cost energy related to system blowdown loss
$K_{boiler}$	boiler fuel operating cost
$k_{electric}$	cost of electrical energy
$k_{fuel}$	unit cost of fuel
$k_{fuel\_1}$	cost of fuel 1
$k_{fuel\_2}$	cost of fuel 2
$K_{shell}$	fuel cost energy related to shell loss
$k_{steam}$	unit cost of steam or steam cost indicator
$kW$	electric power generated by the steam turbine
$m_{blowdown}$	mass flow rate of blowdown from the boiler
$m_{blowdown\_current}$	current mass flow rate of blowdown from the boiler
$m_{blowdown\_new}$	new mass flow rate of blowdown from the boiler
$m_{condensate}$	mass flow rate of condensate returned
$m_{fuel}$	fuel flow rate
$m_{PRV}$	mass flow rate of steam through PRV
$m_{steam}$	mass flow rate of steam from the boiler
$m_{steam\_saved}$	mass flow rate of steam saved
$m_{turbine}$	mass flow rate of steam through turbine
$m_{water\_in}$	mass flow of water into a vessel
$m_{water\_out}$	mass flow of water out of a vessel
$P_{steam}$	steam pressure
$Q_{air\_1}$	heat transferred to the air in current operation
$Q_{air\_2}$	heat transferred to the air in the new operation
$Q_{bd\_boiler}$	blowdown thermal energy content loss for the boiler
$Q_{bd\_savings}$	blowdown reduction thermal energy savings



$Q_{bd\_system}$	system blowdown thermal energy content loss
$Q_{condensate}$	amount of thermal energy in condensate compared to makeup water
$Q_{enduse}$	heat transferred to the enduses
$Q_{saved\_insulation}$	energy savings associated with insulating surfaces
$Q_{steam}$	heat transferred by steam
$Q_{water}$	heat transferred to water in a heat exchanger
$T$	operating hours
$T_{in}$	inlet temperature
$T_{out}$	outlet temperature
$V_{air}$	volume flow rate of air
$V_{condensate}$	volume flow rate of condensate returned
$W_{actual}$	shaft work done by the actual turbine
$W_{ideal}$	shaft work done by the ideal (or perfect) turbine

## Greek Symbols

$\beta$	boiler blowdown ratio as a percent of feedwater
$\eta_{boiler}$	boiler efficiency
$\eta_{boiler\_1}$	boiler efficiency with fuel 1
$\eta_{boiler\_2}$	boiler efficiency with fuel 2
$\eta_{current}$	current boiler efficiency
$\eta_{new}$	new boiler efficiency
$\eta_{turbine}$	turbine isentropic efficiency
$\lambda_{bd\_system}$	system blowdown loss
$\lambda_{blowdown}$	boiler blowdown loss
$\lambda_{miscellaneous}$	boiler miscellaneous losses
$\lambda_{shell}$	boiler shell loss
$\lambda_{stack}$	boiler stack loss
$\rho_{air}$	density of air
$\rho_{condensate}$	density of condensate
$\sigma$	fuel cost savings
$\sigma_{CHP}$	net economic benefit associated with running a steam turbine
$\sigma_{condensate}$	fuel cost savings associated with returning condensate
$\sigma_{electric}$	electrical energy cost savings associated with running a steam turbine
$\sigma_{ExcessAir}$	fuel cost savings associated with implementing excess air control
$\sigma_{fuel}$	fuel energy cost increase associated with running a steam turbine
$\sigma_{FuelSwitch\_savings}$	fuel cost savings associated with implementing excess air control
$\sigma_{insulation}$	fuel cost savings associated with insulating surfaces
$\sigma_{steam}$	fuel cost savings associated with saving steam
$\sigma_{steamleak}$	fuel cost savings associated with eliminating a steam leak



# 1. INTRODUCTION

---

This Manual for Industrial Steam Systems Assessment and Optimization is intended for steam system operators and maintenance staff, energy managers, facility and consulting engineers. This Manual will discuss methods of system efficiency improvements, methodologies for quantifying energy and cost savings from these improvements, aspects of implementation and continuous improvement programs.

## 1.1. Industrial Steam Users

Steam usage is very widespread in the industry. Industry data shows that average steam energy usage in industry could be as much as 35-40% of the onsite energy usage. Hence, it is very important to optimize these systems and minimize their operating costs. Nevertheless, no two systems or processes are alike and it is very difficult to generalize between steam systems. Industrial steam systems can be classified into three categories based on their pressure levels, amount of steam usage and a multitude of processes that use steam as a heating, stripping, drying and power generating source:

- Heavy Steam Users
  - Petrochemicals
  - Refining
  - Forest Products
  - Food & Beverage
  - Plastics
  - Rubber
  - Textiles
  - Pharmaceuticals
  - Manufacturing Assembly
- Medium Steam Users
  - Large commercial heating
  - Breweries
  - Laundries
  - Bakeries
  - Metal Fabrication
  - Large chiller plants
- Small Steam Users
  - Electronics
  - Paint booths
  - Humidification systems



## 1.2. Advantages of Using Steam

Steam is an extremely efficient heating source which maintains a constant temperature and has high heat transfer coefficients. Steam has the highest amount of transferrable energy (in the form of latent heat) per unit mass and hence becomes an extremely cost-effective medium of heat transfer. Steam flows through the system unaided by external energy sources such as pumps and can be controlled very accurately. When saturated steam is used, the temperature and pressure of the steam are correlated by thermodynamics and hence system temperature can be controlled very accurately by controlling the steam pressure to the end-use. Steam, by nature, is a very flexible energy transfer medium that can be used for process heating as well as power generation.

## 1.3. The Systems Approach

For understanding and evaluating any industrial utility system, the key to cost-effectiveness is to take a “Systems Approach”. For a Systems Approach, the user needs to consider the whole steam system rather than investigate just a single component. The general approach for a steam systems optimization starts with the establishment of current system conditions and operating parameters followed by an understanding of both the supply and demand sides of the system. The potential areas (projects) for steam systems optimization are then identified, analyzed and implemented to meet both the plant operational and financial constraints. As a final step, the overall system performance is continuously monitored and trended to ensure that as the process needs changing the system remains in its optimal configuration.



## 2. FUNDAMENTALS OF STEAM SYSTEMS

### 2.1. Generic Steam Systems and Components

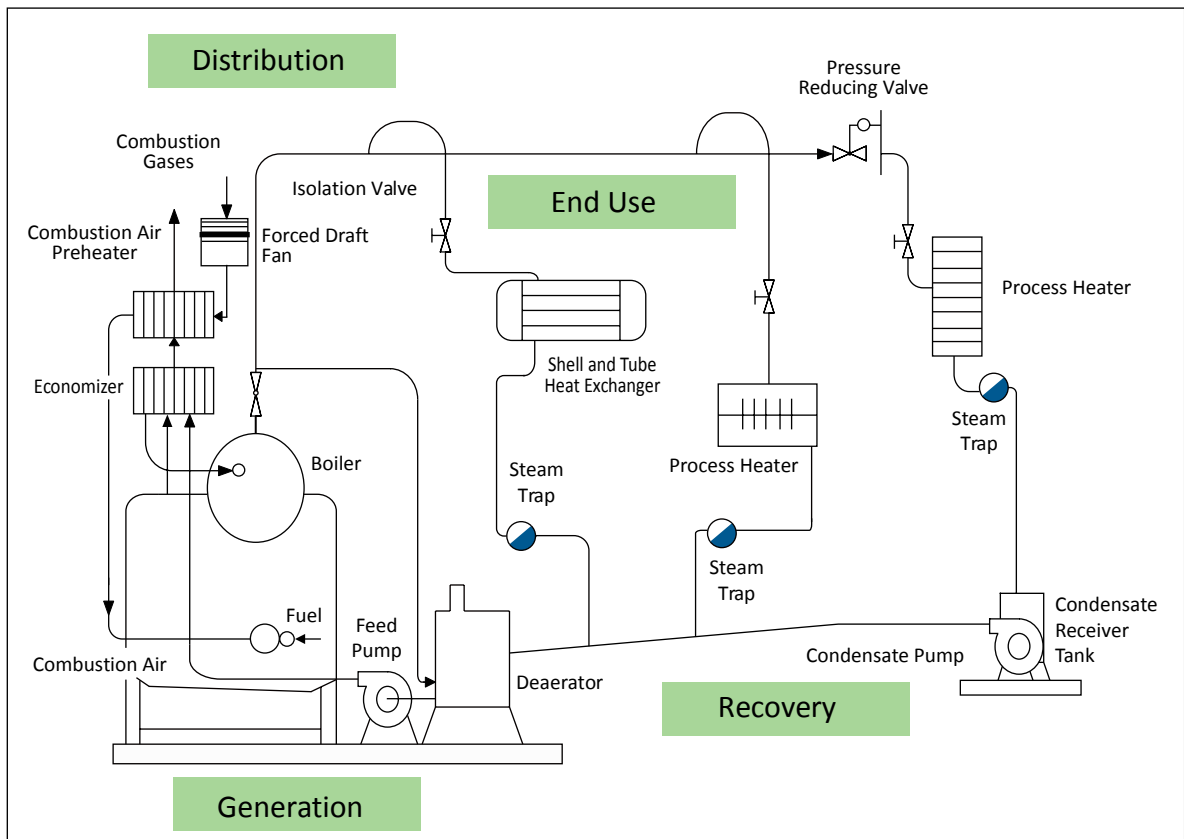


Figure 1: Generic Steam System

(Courtesy: US DOE Steam BestPractices Program – Steam System Sourcebook)



Any generic steam system (industrial, commercial, institutional) will have four major areas:

- Generation
- Distribution
- End-Use and/or Cogeneration
- Condensate Recovery

Upon detailed investigation, it may be found that industrial steam systems will most surely have all the above four areas distinctly separated but smaller systems and institutional plants may or may not have a large distribution system. Combined Heat and Power (CHP) - also termed as Cogeneration - is frequently found in industrial systems which are large steam users. It may or may not exist in medium or small steam users. Additionally, each of these four areas have several components. There may be multiple components performing the same function in an area or there may be certain components that do not exist in a specific system. Nevertheless, it is very important to construct a simple line diagram of the overall system, identifying the major steam system equipment that exists and will need to be investigated using a Systems Approach when evaluating and optimizing industrial steam systems.

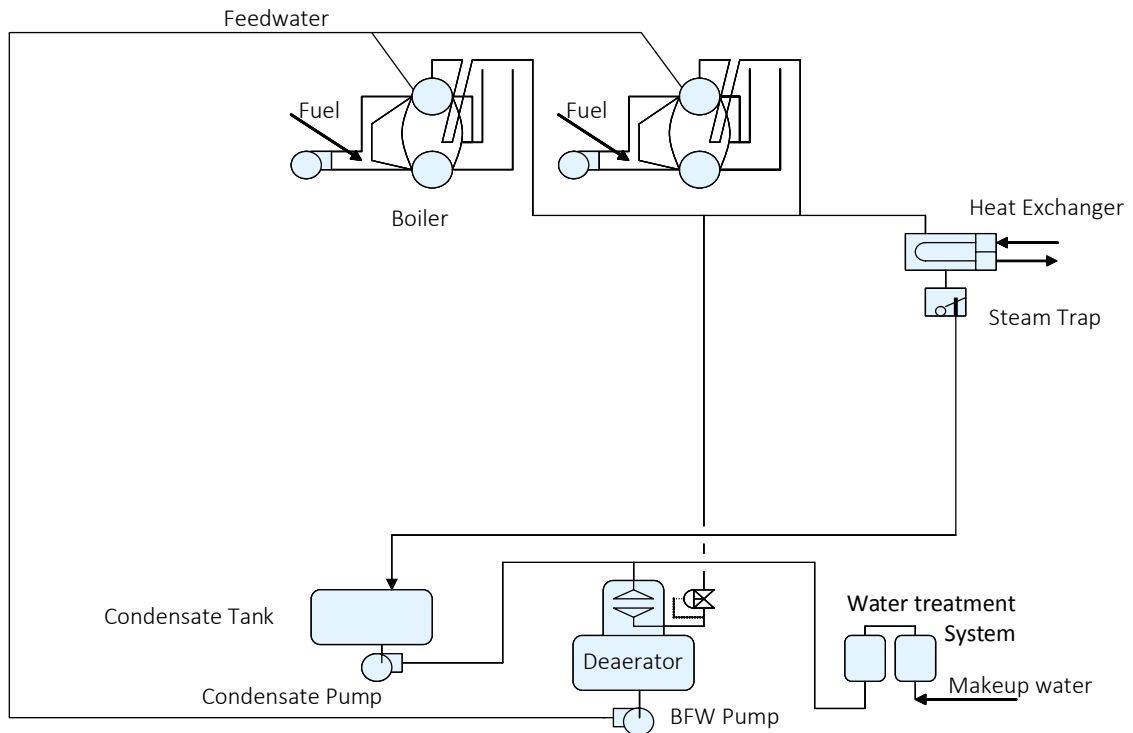
The major components of an industrial steam system (broken down by area) are:

- Generation
  - Boilers
  - Boiler Auxiliaries (Force-Draft, Induced-Draft fans, controls, etc.)
  - Economizers
  - Air Preheaters
  - Water Treatment equipment
  - Deaerator
  - Feedwater Pumps
  - Fuel Storage and Handling equipment
- End-Use and/or Cogeneration
  - Heat Exchangers
  - Stripping columns
  - Evaporators
  - Cookers
  - Dryers
  - Live Steam Injection Process Heating equipment
  - Steam Turbines
- Distribution
  - Steam Piping
  - Pressure Reducing Stations (Valves)
  - Drip legs
  - Steam Accumulators
  - Desuperheaters
- Condensate Recovery
  - Steam Traps
  - Condensate Collection Tanks
  - Condensate Pumps
  - Condensate Piping

As mentioned earlier, it should be noted that a steam system may or may not have all the above mentioned components (equipment) or may have multiples of these components. This is NOT an exhaustive list but it provides information about the components found in the most generic steam systems. For a proper steam systems optimization analysis, an engineer will need to understand the functions and operations of each of the components in the steam system. Additionally, it is very important to understand how each of these components interact with the whole steam system and their impact on the operations and reliability of the steam system.

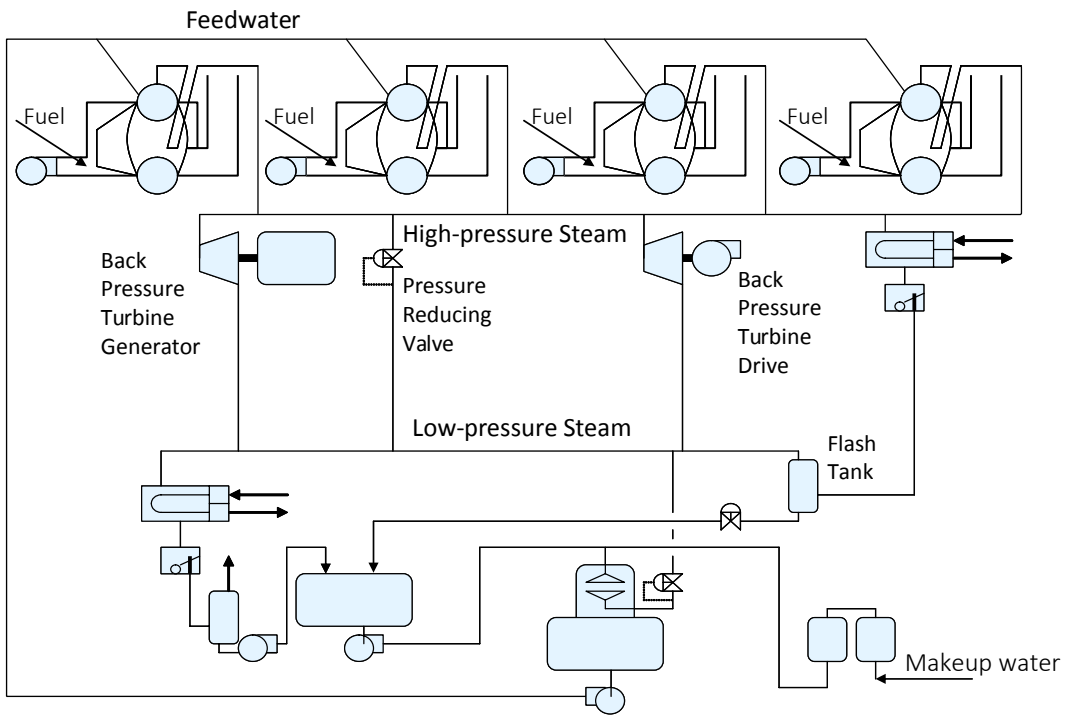
## 2.2. Steam System Line Diagrams

A Steam System Line Diagram is a very simple tool that puts down on a single sheet of paper the overall steam system. The main purpose of the line diagram is to understand at a very high level the steam system operations at a plant (or facility) without getting into technical details and specific operating conditions. This line diagram should list all the major components as well as those that will possibly become impact components. Figures 2a, 2b, 2c and 2d represent examples of basic steam system line diagrams with an increasing order of complexity.

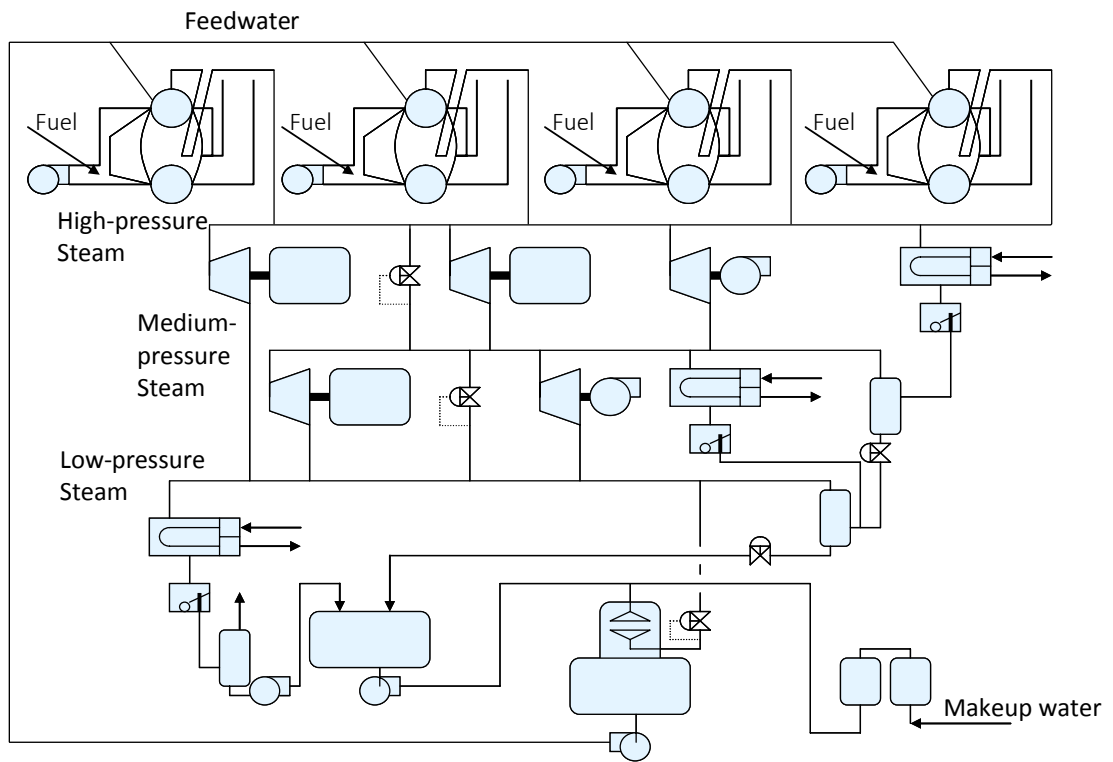


**Figure 2a: A 1-Pressure Header Steam System Line Diagram**  
(Courtesy: US DOE Steam BestPractices End User Training Program)

It has to be noted that even in the simplest of steam systems (as shown in Figure 2a), a line diagram provides all the necessary high level information that one would need to have for doing a detailed steam systems optimization. All the components are marked here and though these specific component symbols do not follow any international standards, their main purpose is to identify and schematically show their location in the overall steam system and depict their operations. The subsequent figures 2b, 2c and 2d will use these same symbols for the components but will not call them out individually unless a “new” component is introduced in the figure. Users of this Training Manual are once again reminded that each steam system in industry is unique but the general components and their operations are very similar. Hence, a user will have to develop a line diagram for each and every steam system that needs a steam system optimization assessment.



**Figure 2b: A 2-Pressure Header Steam System Line Diagram**  
(Courtesy: US DOE Steam BestPractices End User Training Program)



**Figure 2c: A 3-Pressure Header Steam System Line Diagram**  
(Courtesy: US DOE Steam BestPractices End User Training Program)

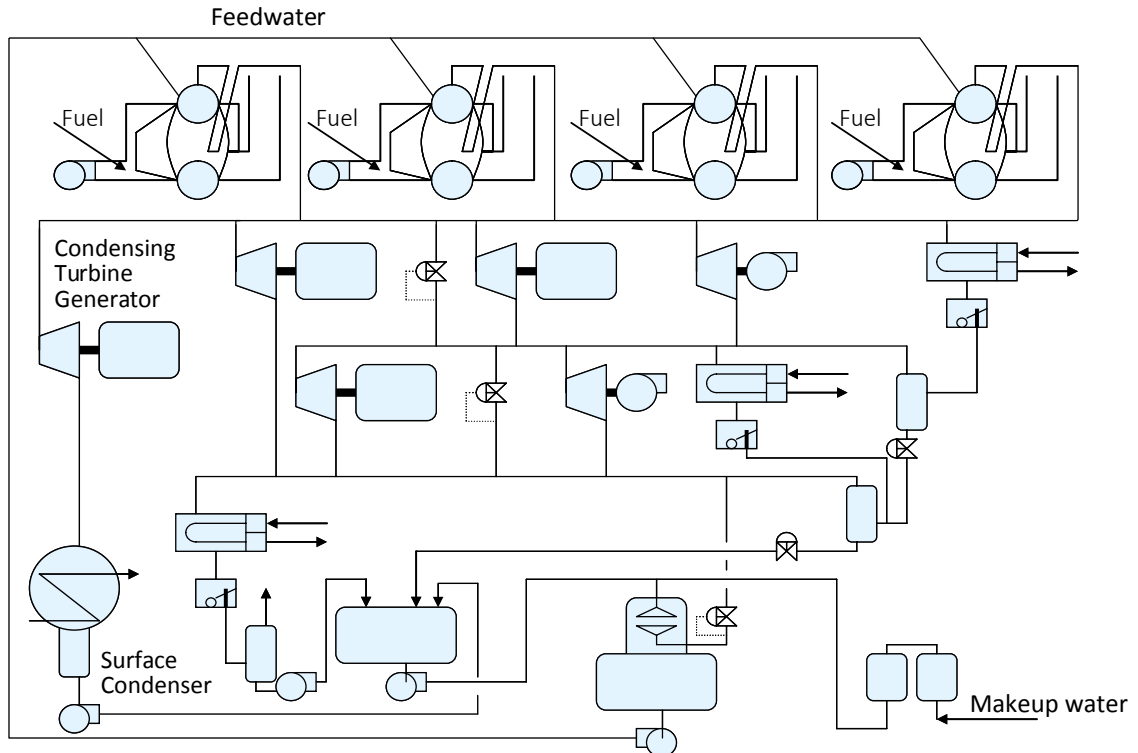


Figure 2d: A 3-Pressure Header w/Condensing Turbine Steam System Line Diagram  
(Courtesy: US DOE Steam BestPractices End User Training Program)

### 2.3. Steam Thermodynamics

The three basic thermodynamic states of water (in an industrial steam system) are subcooled, saturated, and superheated. Each is defined as follows:

**Subcooled:** Water is in the form of liquid and its temperature is lower than the saturation temperature (at the existing pressure). The energy content of subcooled water is directly proportional to its temperature.

**Saturated:** As sub-cooled water is heated it reaches its saturation temperature. This state is called saturated liquid (water). Adding more heat leads to a change in its state from liquid to vapor without a change in temperature. This change of phase continues until it all becomes vapor. This state is now called saturated vapor (steam). The energy content of the saturated state is a function of temperature (or pressure) and quality (amount of vapor in the 2-phase mixture).

**Superheated:** A further increase in heat input to the saturated vapor state leads to an increase in the steam temperature beyond the saturation point. This is the superheated state of steam. The energy content of the superheated steam is proportional to both temperature and pressure.

Based on the state of steam dictated by the pressure and temperature, thermodynamic properties such as the following can be obtained from Steam Tables:



- Pressure (*bars, atmospheres, kPa, MPa*)
- Temperature ( $^{\circ}\text{C}$ )
  - Absolute Temperature ( $\text{K}$ )
- Quality
- Density ( $\text{kg}/\text{m}^3$ )
- Volume ( $\text{m}^3/\text{kg}$ )
- Enthalpy ( $\text{kJ}, \text{kcal}$ )
  - Specific Enthalpy – ( $\text{kJ}/\text{kg}, \text{kcal}/\text{kg}$ )
- Entropy ( $\text{kJ}/\text{K}, \text{kcal}/\text{K}$ )
  - Specific Entropy ( $\text{kJ}/\text{kg-K}, \text{kcal}/\text{kg-K}$ )

Steam Tables are available in several different forms including the Mollier Diagram, the  $P$ - $h$  diagram, tabulated data in handbooks and standards, Equation-of-State, etc. Appendix A provides easy to reference Steam Tables from the REFPROP software developed by the National Institute of Standards & Testing (NIST), USA. It is important to note that Steam Tables from different sources may vary for enthalpy and entropy values because their reference point (Enthalpy = 0) may not be the same. Hence, it is critical that throughout the steam system analysis the **SAME** source of steam tables be used.

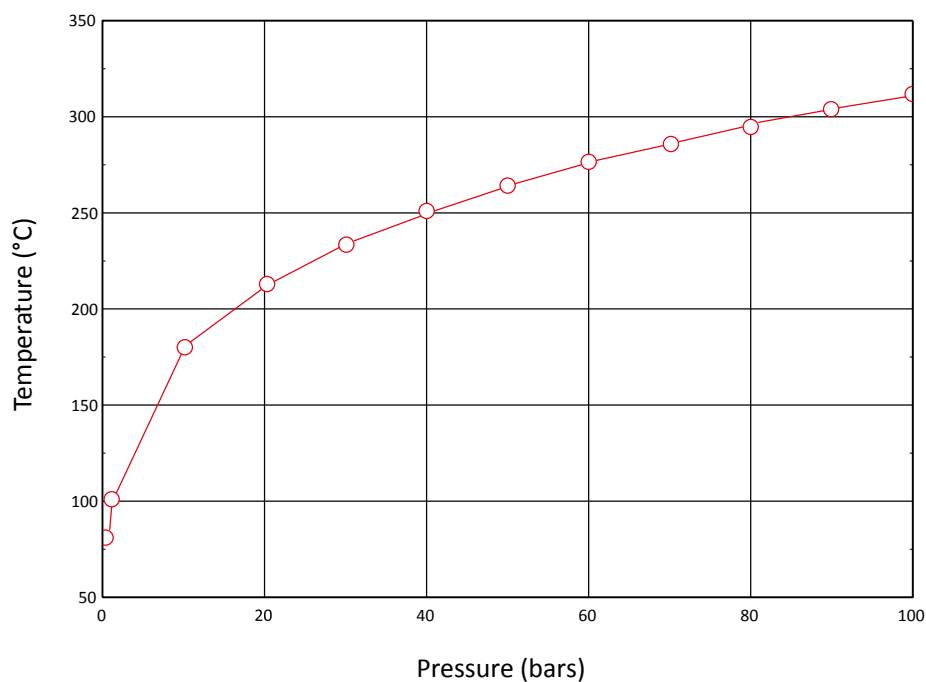


Figure 3: Saturation Temperature – Pressure Relationship for Steam

Figure 3 presents the saturation temperature - pressure relationship for steam. As can be observed, saturation temperature and pressure exhibit a non-linear relationship. Figure 4 provides the steam properties in a graphical manner, commonly known as the Mollier Diagram. It provides a relationship between pressure, temperature, enthalpy, entropy, quality and specific volume. The bold “red” line represents the saturation curve of steam. To the left of the saturation curve is the “subcooled liquid (water)” region and on the right side of the graph above the saturation curve is the “superheated vapor (steam)” region. Within the saturation curve, the lines indicate the quality of the two-phase and there lies the “saturated” region.



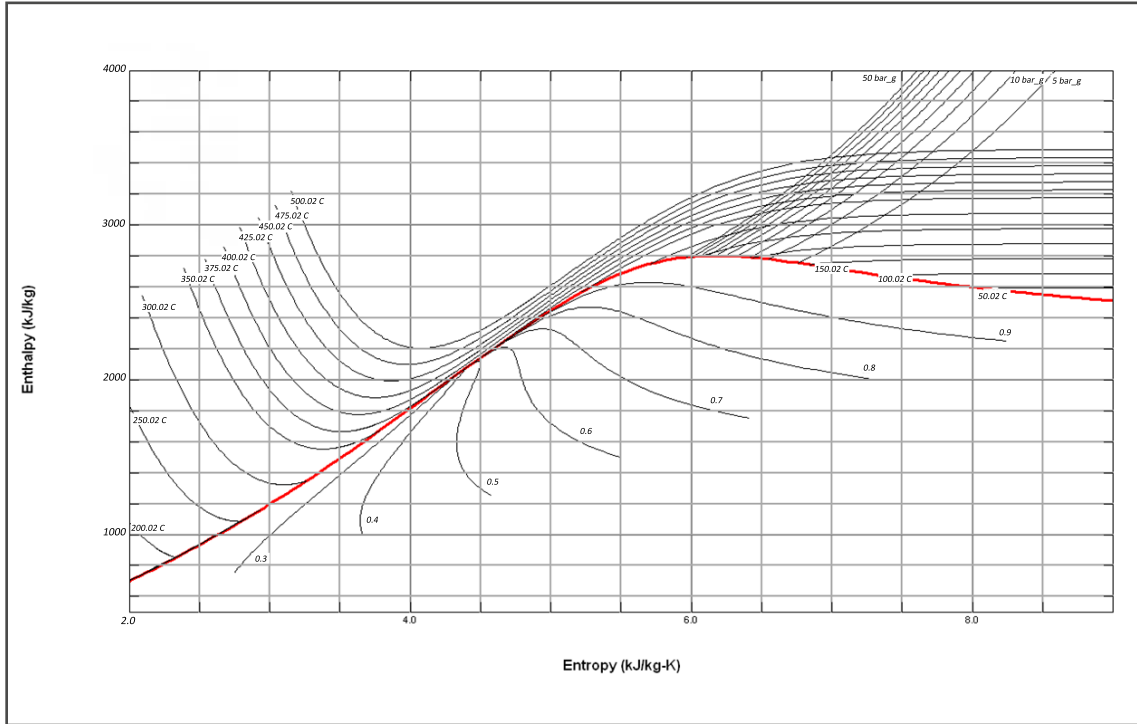


Figure 4: Mollier Diagram (Steam)

## 2.4. Fundamental Laws & Principles

### **Conservation of Mass**

The conservation of mass states that *Mass can neither be created nor destroyed in a control volume. It can only change its state.*

### **Conservation of Energy (1<sup>st</sup> Law of Thermodynamics)**

The conservation of energy states that *Energy can neither be created nor destroyed in a control volume. It can only be changed from one form to another.*

### **Principle of Steady State Steady Flow (SSSF)**

SSSF means that the rate of change of mass and energy in a control volume are each equal to zero. This implies that there is no storage of mass or energy in the control volume that is being analyzed. Additionally, steady state implies that the individual operating parameters (temperature, pressure, flows) DO NOT vary over the time period in which the analysis is being conducted.

The Conservation of Mass and Energy laws and the SSSF principle are the cornerstone of any industrial steam system optimization efforts. Dynamic analysis, start-up, shut-down and upset conditions are typically neglected while conducting steam systems optimization. Energy experts and end-users will need to have a very good understanding of the steam system dynamics in order to be able to determine whether the system does conform to SSSF conditions.



# 3

## 3. SCOPING THE INDUSTRIAL STEAM SYSTEM

---

Understanding the current operations and management of the industrial steam system to be optimized is the first step in beginning the process of Steam Systems Optimization (SSO). Secondly, realizing the final objective(s) of the SSO and identifying the goals and targets are key in the implementation of SSO at a plant. Most of the time the objectives of SSO are:

- Minimize steam use
- Reduce system-wide energy losses
- Reduce GHG emissions
- **Reduce steam system operating costs**

Before beginning any detailed analysis, there is a strong need to be able to understand the steam system in a systematic manner. The next step would be to identify potential areas that need to be investigated and further due-diligence done on those areas to quantify the system level energy and economic impacts.

This activity can be done in several different forms:

- Face-to-face Q&A session
- Phone interviews
- Questionnaire – to be filled in and returned by plant personnel

One such tool that can be used to scope a system is the US Department of Energy's Steam System Scoping Tool (SSST).

### 3.1. US DOE's Steam System Scoping Tool (SSST)

The SSST is a software-based (MS-Excel) questionnaire that is designed to enhance awareness of the different areas of steam system management. It is divided into typical steam system focus areas and it provides the user with a score that is indicative of management intensity.

The SSST is used to identify potential improvement areas in an industrial steam system. It does this by comparing the steam system being investigated to a state-of-the-art Best Practices industrial steam system. Opportunity gaps are identified and these become the prime targets of investigation in optimizing the steam system. It should be noted that the intention of the SSST is NOT to quantify the energy savings opportunities but rather to identify them.

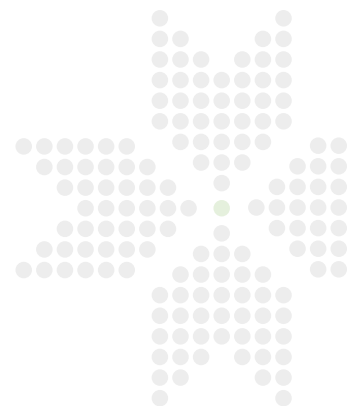
SSST can be used by plant managers, utility engineers and managers, plant process engineers and energy experts who are working on the optimization of steam system operations. There are a total of 26 qualitative questions. These questions are divided into the following sections:

- System profiling
- Overall system operating practices
- Boiler plant operating practices
- Distribution, end-use and recovery operating practices

After completing the questionnaire in SSST, the “Results” page provides the user with a score that is indicative of management intensity and serves as a guide to identifying potential steam system optimization opportunities. Table 1 provides the SSST summary of results for an average industrial steam system.

**Table 1: SSST “Summary of Results” for an Average Industrial Steam System**

Summary of Results Scoping Tool Areas	Possible score	Typical score
Steam system profiling	90	63%
Steam system operating practices	140	69%
Boiler plant operating practices	80	63%
Distribution, end use, recovery op. practices	30	58%
<b>Total scoping tool questionnaire score</b>	<b>340</b>	<b>222.0</b>
<b>Total scoping tool questionnaire score</b>	<b>100%</b>	<b>65%</b>



## 4. MODELING THE INDUSTRIAL STEAM SYSTEM

---

After having gained a good understanding of the potential improvement opportunities from the Scoping section, the next step in the overall steam systems optimization is to develop a “Steam System Model” that accurately reflects the overall steam system balance, models all the impact components and can realistically model the true energy and economic benefits of steam systems optimization projects.

There are several high-fidelity and commercially available software tools that can develop an accurate and robust industrial steam system model for the plant. These models can be customized and can provide extremely detailed performance and operating information, as required for a high level of due-diligence. But these may also be expensive and training will be required to build steam system models that reflect the industrial plant’s steam system. Additionally, there may be several proprietary softwares, applets and engines available from the internet (both free and at a charge) that can be used for modeling steam systems.

The intent of this section is NOT to emphasize a particular steam system modeling tool or software but to make users aware of all the characteristics and requirements needed for undertaking a steam system optimization activity. The main goal of modeling the steam system is to provide the user with the ability to understand the energy and economic impacts of steam system optimization projects. It is of paramount importance that any modeling or software tools be based on:

- Fundamental laws of conservation of mass and energy
- Economic balance
- Preserving steam balance on headers
- Impact cost and component (equipment) modeling analysis
- Using a systems approach

One such industrial steam system modeling software is the US DOE’s Steam System Assessment Tool (SSAT). It is MS-Excel based and has the ability to model common steam system optimization projects and do a “what-if” analysis.

## 4.1. US DOE's Steam System Assessment Tool (SSAT)

The SSAT is set-up with 3 pre-defined steam system templates: 1-header, 2-header and 3-header. Figures 5a, 5b and 5c show the different header configurations and represent the pre-built system templates. Each SSAT template has the following worksheets:

- Input – to provide system level information
- Model – line diagram of the system showing headers, steam balance, heat duties, etc.
- Projects Input – to turn “ON” projects and modify system operations
- Projects Model – line diagram of the system with the included projects
- Results – tabulated information of the energy and economic impacts
- Stack Loss Chart – determines stack loss for certain fuels
- User Calculations – for performing any data analysis and calculations outside the model

Figure 5a: SSAT “1-Header” Steam System Model

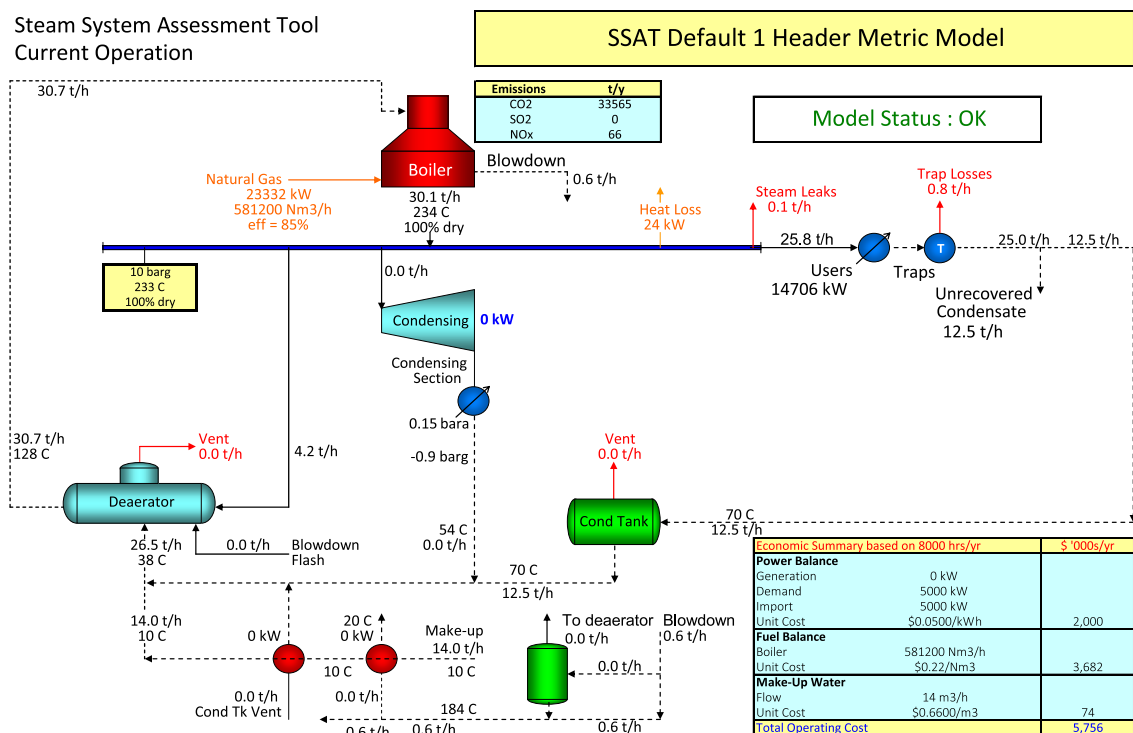




Figure 5b: SSAT “2-Header” Steam System Model

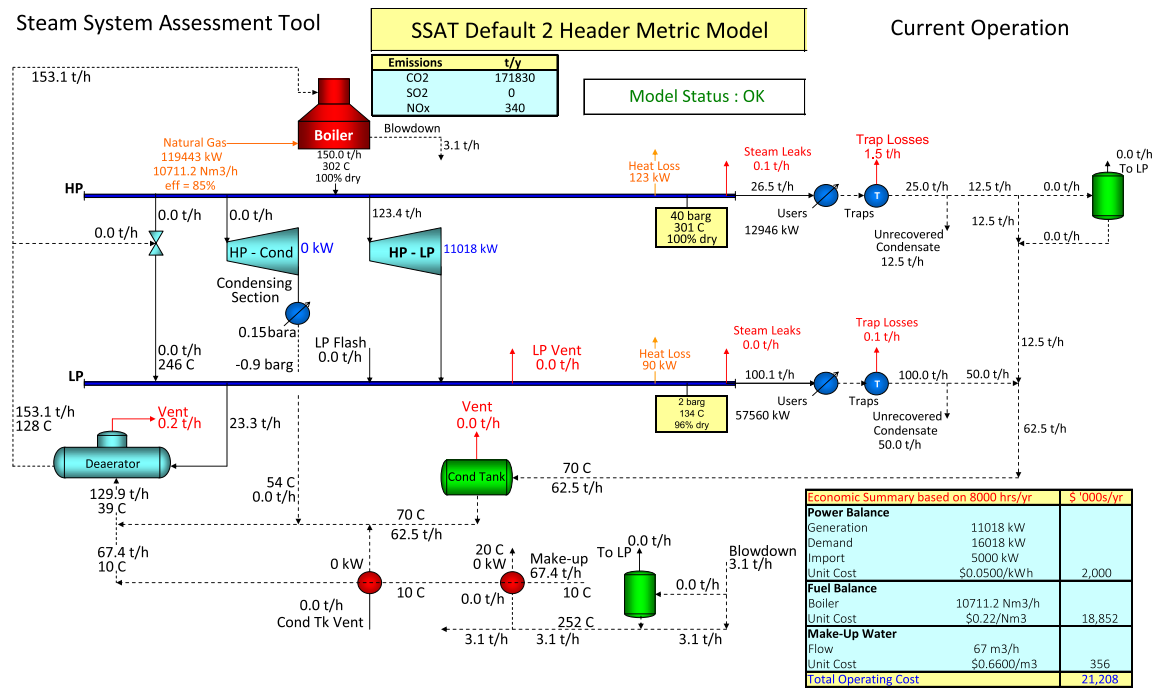
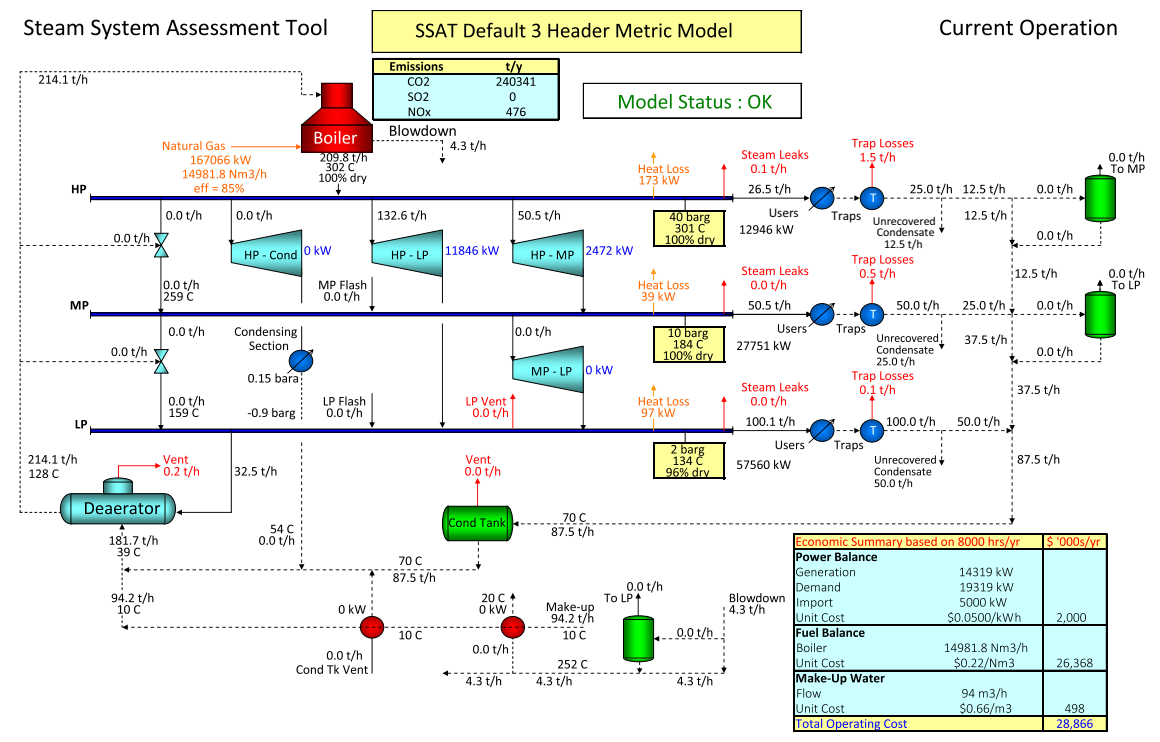


Figure 5c: SSAT “3-Header” Steam System Model



## 4.2. Steam Systems Optimization Projects in SSAT

The 3-header SSAT steam system model is the superset of the 1-header and 2-header models and is the most comprehensive steam system model available in SSAT. The “Input” page will require significant site detail information to accurately model the system being evaluated. The input information required is always pre-populated with defaults; the user can therefore run the steam system model right away. As more site information becomes available, it can be added to the “Input” page to make the steam system model a representative of the actual steam system.

There are 18 steam system optimization projects built into the “Projects Input” page that can be turned ON to modify the existing steam system. This allows the user to do a “what-if” analysis on the steam system being optimized. Additionally, SSAT provides a cumulative analysis of multiple projects that can be done for optimizing the steam system. The SSAT model takes a true “Systems Approach” and has the following 18 steam system optimization projects that can be evaluated for any steam system:

- Steam Demand Savings
- Use an alternative fuel (fuel switching)
- Change boiler efficiency
- Change boiler blowdown rate
- Implement blowdown flash tank to generate low pressure steam
- Change steam generation conditions
- Install and/or modify high pressure to low pressure / backpressure steam turbine
- Install and/or modify high pressure to medium pressure / backpressure steam turbine
- Install and/or modify medium pressure to low pressure / backpressure steam turbine
- Install and/or modify condensing steam turbine
- Install make-up water heat recovery exchanger on condensate tank vent
- Install make-up water heat recovery exchanger on boiler blowdown
- Improve condensate recovery
- Flash high pressure condensate to create medium pressure steam
- Flash medium pressure condensate to create low pressure steam
- Implement a steam trap management program
- Implement a steam leaks management program
- Improve insulation on steam and condensate lines and equipment

Figure 6 shows a snapshot of the “Results” page which provides tabulated information on the energy and economic impacts of steam systems optimization.

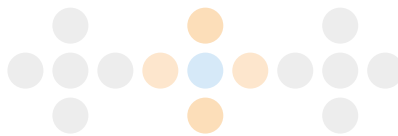




Figure 6: SSAT “3-Header” Steam System Model “Results” Page

**Steam System Assessment Tool**

**3 Header Model**

**Results Summary**

SSAT Default 3 Header Model

Model Status: OK

Cost Summary (\$ '000s/yr)	Current Operation	After Projects	Reduction	
Power Cost	2,000	2,000	0	0.0%
Fuel Cost	24,178	24,178	0	0.0%
Make-up Water Cost	453	453	0	0.0%
Total Cost (in \$ '000s/yr)	26,631	26,631	0	0.0%

On-site Emissions	Current Operation	After Projects	Reduction	
CO2 Emissions	486135 klb/yr	486135 klb/yr	0 klb/yr	0.0%
SOx Emissions	0 klb/yr	0 klb/yr	0 klb/yr	N/A
NOx Emissions	962 klb/yr	962 klb/yr	0 klb/yr	0.0%

Power Station Emissions	Reduction After Projects	Total Reduction	
CO2 Emissions	0 klb/yr	0 klb/yr	-
SOx Emissions	0 klb/yr	0 klb/yr	-
NOx Emissions	0 klb/yr	0 klb/yr	-

Note - Calculates the impact of the change in site power import on emissions from an external power station. Total reduction values are for site + power station

Utility Balance	Current Operation	After projects	Reduction	
Power Generation	13883 kW	13883 kW	-	-
Power Import	5000 kW	5000 kW	0 kW	0.0%
Total Site Electrical Demand	18883 kW	18883 kW	-	-
Boiler Duty	523.0 MMBtu/h	523.0 MMBtu/h	0.0 MMBtu/h	0.0%
Fuel Type	Natural Gas	Natural Gas	-	-
Fuel Consumption	522874.9 s cu.ft/h	522874.9 s cu.ft/h	0 s cu.ft/h	0.0%
Boiler Steam Flow	416.5 klb/h	416.5 klb/h	0 klb/h	0.0%
Flow Cost (in \$/MMBtu)	5.78	5.78	-	-
Power Cost (in \$/MMBtu)	14.65	14.65	-	-
Make-Up Water Flow	22660 gal/h	22660 gal/h	0 gal/h	0.0%

Turbine Performance	Current Operation	After Projects	Marginal Steam Costs	
HP to LP steam rate	44 kWh/klb	44 kWh/klb	(based on current operation)	
HP to MP steam rate	23 kWh/klb	23 kWh/klb	HP (\$/klb)	8.28
MP to LP steam rate	Not in use	Not in use	MP (\$/klb)	7.16
HP to Condensing steam rate	Not in use	Not in use	LP (\$/klb)	6.06



## 5. STEAM GENERATION OPTIMIZATION OPPORTUNITIES

---

The steam generation area is the focus of attention in any steam systems optimization study. This is justified because the generation area is where fuel energy is supplied to produce steam. Fuel is typically purchased at a cost and releases a certain amount of energy in the combustion process that is then captured by the boiler to produce steam.

### 5.1. Fuel Properties

There are several different kinds of fuels used to produce steam in industrial plants. Some of the common fuels include:

- Solid – Coal, Wood, Biomass, Tire-Derived Fuel, etc.
- Liquid – Heavy fuel oil, Light fuel oil, Paraffin, Waste liquids for incineration, etc.
- Gas – Natural gas, Methane gas, Refinery off gas, etc.

Individual boiler design is based on the fuel used. In the industry, there are several situations where dual-fuel fired boilers are in operation; this allows for fuel flexibility and enhances the reliability of steam generation in the event of any fuel supply disruptions.

Every fuel has a “Heating Value” which is defined as the energy content of the fuel given either on a mass or volume basis. Most solid and liquid fuels have heating values defined on a mass basis (GJ/ton, KJ/kg or Kcal/kg). Most gaseous fuels have their heating values defined on a volume basis (KJ/m<sup>3</sup> or Kcal/m<sup>3</sup>). Conversion between mass-based and volume-based heating values can be carried out if the fuel density is known.

#### **Higher Heating Value (HHV)**

This is also known as the Gross Heating Value. It is the total energy provided by the fuel that is obtained after water vapor in the flue gas stream is condensed back to its natural state (liquid water). Hence, it contains the latent heat of water which is recovered when the water vapor condenses back to liquid water.



### Lower Heating Value (LHV)

This is also known as the Net Heating Value. It is the total energy provided by the fuel that is obtained without the condensation of the water vapor in the flue gas stream.

Heating values can be obtained from several different sources including: fuel supplier, chemical and mechanical engineering handbooks, laboratory analysis of fuel samples, etc. All throughout this Training Manual, the fuel's HHV will be used in all the calculations. Using HHV in steam systems optimization analysis is a more accurate methodology and results in a complete energy balance of the system. Nevertheless, LHV can also be used for same analysis and will produce identical results. It is important that users be CONSISTENT while doing the steam systems optimization analysis and ensure that project analyses are completed with either HHV or LHV. Switching between the two will produce erroneous results. Table 2 provides the HHV for some of the commonly used boiler fuels.

**Table 2: Higher Heating Values of Common Fuels**

Fuel	Sales Unit	Typical Cost [\$/sales unit]	HHV [kJ/kg]	Unit Price [\$/GJ]
Natural Gas	Nm <sup>3</sup>	1.00	54,220	26.35
Number 2 Fuel Oil	tonne	1,500	45,125	33.24
Number 6 Oil (LS)	tonne	785	43,595	18.01
Number 6 Oil (HS)	tonne	797	43,764	18.21
Bituminous Coal	tonne	171	31,890	5.36
SubBituminous Coal	tonne	129	23,465	5.50
Green Wood	tonne	22	12,215	1.80

## 5.2. Steam Generation Cost

Along with the HHV, Table 2 also presents the typical cost of the fuel in two configurations – cost per sales unit and cost per unit of energy (GJ). The fuel cost is the most important parameter for calculating the steam generation cost and the steam cost indicator.

$$K_{boiler} = m_{fuel} \times k_{fuel}$$

where  $K_{boiler}$  is the total fuel operating cost of the boiler and  $m_{fuel}$  and  $k_{fuel}$  are the fuel flow rate and the fuel cost, respectively.

$$k_{steam} = \frac{m_{fuel} \times k_{fuel}}{m_{steam}}$$

where  $k_{steam}$  is the steam cost indicator (or unit cost of steam production) from the boiler and  $m_{steam}$  is the steam flow rate.

### Example

Calculate the hourly natural gas boiler fuel cost that generates steam at 20 Tph (steady – all year). The measured natural gas flow rate is 1,693 m<sup>3</sup>/hr (28 m<sup>3</sup>/min) and the cost of natural gas is (\$1.0/m<sup>3</sup>).

$$K_{boiler} = 1,693 \times 1.0 = \$1,693/hr$$

$$K_{boiler} = 1,693 \times 1.0 \times 8,760 = \$14,830,680/yr$$

$$k_{steam} = \frac{1,693}{20} = \$84.60/tonne$$

The hourly cost for generating 20 Tph steam from this natural gas boiler is \$1,693 and the marginal fuel-related steam cost (Steam Cost Indicator) is \$84.60 per tonne of steam generated.

### 5.3. Boiler Efficiency Calculation (Direct Method)

Boiler efficiency (or steam generation efficiency) is defined as the ratio of the heat absorbed by feedwater to generate steam and the fuel input energy.

$$\eta_{boiler} = \frac{m_{steam} (h_{steam} - h_{feedwater})}{m_{fuel} \times HHV_{fuel}} \times 100$$

where  $h_{steam}$  and  $h_{feedwater}$  are the enthalpies of steam and feedwater, respectively.

This equation can be applied to a specific boiler or a complete boiler plant. It can be applied for an instantaneous snapshot or any defined time-period (daily, month, annual, etc.). This is known as the “Direct Method” for calculating boiler efficiency. Boiler efficiency varies significantly based on the fuel used, installed equipment and controls, boiler design, operating load, etc. Typically, boiler efficiency is expected to be ~70-75% (for wood); 80-85% (for natural gas); and 85-90% (for oil and coal). Figure 7 presents a typical boiler efficiency curve based on actual data collected from a natural gas boiler.

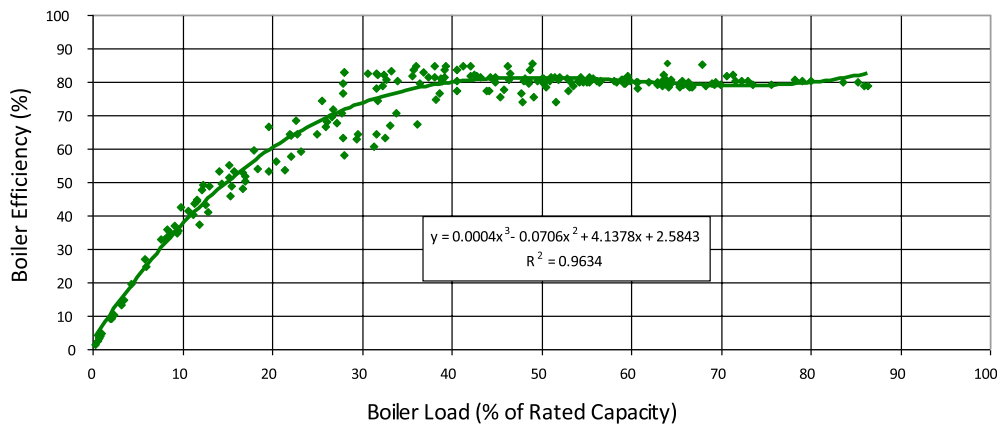


Figure 7: Typical Natural Gas Fired Boiler Efficiency Curve

#### Example

Calculate the natural gas boiler efficiency that generates steam at 20 Tph (steady – all year). The measured natural gas flow rate is 1,693 m<sup>3</sup>/hr (28 m<sup>3</sup>/min) and the cost of natural gas is (\$1.0/m<sup>3</sup>). The HHV of the natural gas is 54,220 kJ/kg (40,144 kJ/m<sup>3</sup>). Superheated steam is generated at 25 bars, 375°C and boiler feedwater from the deaerator is at 30 bars, 110°C.



From the information provided,

- $m_{steam} = 20,000 \text{ kg/hr}$
- $h_{steam} = 3,181 \text{ kJ/kg}$  (from Steam Tables based on 25 bars, 375°C)
- $h_{feedwater} = 463.5 \text{ kJ/kg}$  (from Steam Tables based on 30 bars, 110°C)
- $m_{fuel} = 1,693 \text{ m}^3/\text{hr}$
- $HHV_{fuel} = 40,144 \text{ kJ/m}^3$

Boiler efficiency can be calculated as follows:

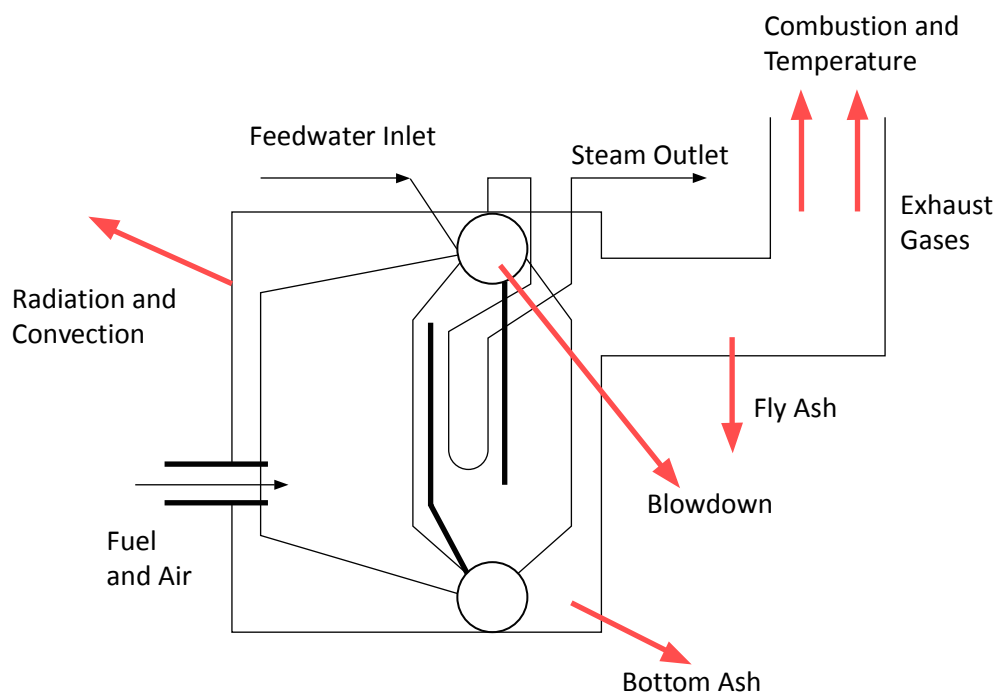
$$\eta_{boiler} = \frac{m_{steam} (h_{steam} - h_{feedwater})}{m_{fuel} \times HHV_{fuel}} \times 100$$
$$\eta_{boiler} = \frac{20,000 (3,181 - 463.5)}{1,693 \times 40,144} \times 100$$
$$\eta_{boiler} = 80.0\%$$

## 5.4. Boiler Efficiency Calculation (Indirect Method)

Boiler efficiency can also be determined in an indirect manner by determining the magnitude of the individual energy losses. Figure 8 schematically provides information about the major energy losses that occur in an operating boiler.

Figure 8: Operating Boiler Losses

(Courtesy: US DOE Steam BestPractices End User Training Program)



There are different kinds of losses in an operating boiler: Shell loss, Blowdown loss, Stack (Combustion and Temperature) loss, Fly and Bottom ash loss, Loss on Ignition (LOI), etc. Using an energy balance on the boiler, the boiler efficiency can be calculated as:

$$\eta_{boiler} = 100 - \lambda_{shell} - \lambda_{blowdown} - \lambda_{stack} - \lambda_{miscellaneous}$$

where  $\lambda_{shell}$  represents the Shell loss (%);  $\lambda_{blowdown}$  represents the Blowdown loss (%);  $\lambda_{stack}$  represents the Stack loss (%); and  $\lambda_{miscellaneous}$  represents the other losses (%).

This is known as the “Indirect Method” of calculating boiler efficiency. It requires significantly more information from the operating boiler compared to the “Direct Method” of boiler efficiency calculation and is more time consuming than the “Direct Method”. Nevertheless, the “Indirect Method” has significant advantages over the “Direct Method” including:

- Less uncertainty (higher accuracy)
- Ability to pinpoint and quantify the areas of energy losses

From a steam systems optimization analysis, both methods should be used independently to calculate boiler efficiency. The calculated values can then be compared; this will help to build confidence levels in the plant instrumentation and data gathering devices.

### 5.4.1. Shell Loss

Shell loss is the amount of fuel energy that leaves the boiler from its outer surface. The surface of the boiler is above ambient temperature and hence, there is always a certain amount of heat lost to the surroundings. This heat loss occurs due to radiation and convection from the boiler surfaces. It is difficult to accurately measure the shell loss from a boiler. It is generally estimated from some limited field measurements. The American Society of Mechanical Engineers Performance Test Code 4 (ASME-PTC-4) provides a detailed methodology for calculating this loss from the boiler surfaces.

A first order of magnitude shell loss is provided in Table 3 below as a guide. The shell loss estimation methodology utilizes the characteristic temperature of a boiler surface, surface area and an estimated ambient surface airflow velocity. These estimates are used to complete a heat transfer analysis for all of the surfaces of the boiler and yield an estimate for the overall boiler shell loss. This technique is simple; however, the results must be considered a general estimate.

**Table 3: First Order Shell Loss Guide**

Shell Loss Gross Estimate Field Evaluations				
Boiler Type	Steam Production Rating		Boiler Full-Load Shell Loss Estimate	
	Minimum [Tph]	Maximum [Tph]	Maximum [%]	Minimum [%]
Water-tube	5	50	2.0	0.3
Water-tube	50	500	0.6	0.1
Water-tube	500	5,000	0.2	0.1
Fire-tube	0.5	20	1.0	0.1



It should be noted that the boiler shell loss magnitude is constant and is independent of the boiler load. Shell loss is expressed as a percent of fuel input energy. Hence, shell loss (%) increases as the boiler load reduces. For most well-maintained boilers, the full load shell loss is expected to be  $\sim 0.1\%$  to  $2\%$  of total fuel input energy.

### Example

An ASME type investigation of the shell loss for the 20 Tph natural gas boiler indicates that the shell loss is  $\sim 0.5\%$ . The measured natural gas flow rate is  $1,693 \text{ m}^3/\text{hr}$  ( $28 \text{ m}^3/\text{min}$ ) and the cost of natural gas is ( $\$1.0/\text{m}^3$ ). Estimate the fuel input energy cost associated with the shell loss.

From the information provided,

- $m_{\text{fuel}} = 1,693 \text{ m}^3/\text{hr}$
- $k_{\text{fuel}} = 1.0 \text{ \$/m}^3$
- $\lambda_{\text{shell}} = 0.5\%$

$$K_{\text{shell}} = m_{\text{fuel}} \times k_{\text{fuel}} \times \lambda_{\text{shell}}$$

$$K_{\text{shell}} = 1,693 \times 1.0 \times 0.005 = \$8.47/\text{hr}$$

$$K_{\text{shell}} = 8.47 \times 8,760 \approx \$74,200/\text{yr}$$

### 5.4.2. Blowdown Loss

Boiler feedwater is treated make-up water and condensate. However, there are still dissolved chemicals in boiler feedwater which do not exit the boiler with the steam because they are not soluble in steam. As a result, the concentration of these chemicals increases in the boiler. Elevated concentration of chemicals in boilers can result in serious operational problems and boiler integrity can be damaged. These problems could include but are not limited to: foaming resulting in liquid carryover, scaling on the water-side of the tubes resulting in tube leaks and failures, loose sludge in the boiler water, etc.

Blowdown is the primary mechanism that controls the water chemistry of the boiler water. Blowdown controls the concentration of dissolved and precipitated chemicals in the boiler and ensures that the boiler functions reliably and is not subject to an unplanned shutdown or failure.

Generally, blowdown is controlled based on boiler water conductivity. Conductivity is a direct measurement that can continuously provide an indication of boiler water quality. However, conductivity must be correlated to individual chemical contaminants through periodic water analysis. Conductivity and the results of specific boiler water testing aid in adjusting the blowdown rate.

It should be noted that blowdown is saturated liquid at boiler pressure. Hence, there is a significant amount of thermal energy associated with blowdown. As blowdown is discharged from the boiler, this thermal energy (which was provided by the fuel) is lost. The ratio of this energy lost to the total fuel input energy is the blowdown loss -  $\lambda_{\text{blowdown}}$ .

Utilizing conventional flow meters for measuring blowdown flow is difficult because blowdown is saturated water which will flash at the slightest pressure drop. Most flow meter devices will impose a sufficient pressure drop that results in a two-phase flow that is impossible to measure. Hence, in order to measure blowdown, a particular chemical composition in the feedwater and in the boiler water is measured. The chemical component measured in the analysis must be of sufficient concentration to allow an accurate measurement. The ratio of that chemical's concentration in the feedwater to its concentration in the boiler water is used to establish the blowdown rate. Blowdown flow ( $\beta$ ) as a percent of feedwater flow is therefore as follows:

$$\beta = \frac{\text{Blowdown Flow}}{\text{Feedwater Flow}} \approx \frac{\text{Feedwater Conductivity}}{\text{Blowdown Conductivity}}$$

$$m_{\text{blowdown}} = \left( \frac{\beta}{1 - \beta} \right) m_{\text{steam}}$$

where  $m_{\text{blowdown}}$  is the blowdown flow rate. Boiler blowdown thermal energy content loss ( $Q_{\text{bd\_boiler}}$ ) and blowdown loss ( $\lambda_{\text{blowdown}}$ ) are calculated as follows:

$$Q_{\text{bd\_boiler}} = m_{\text{blowdown}} (h_{\text{blowdown}} - h_{\text{feedwater}})$$

$$\lambda_{\text{blowdown}} = \left( \frac{Q_{\text{bd\_boiler}}}{m_{\text{fuel}} \times \text{HHV}_{\text{fuel}}} \right) \times 100$$

where  $h_{\text{blowdown}}$  and  $h_{\text{feedwater}}$  are the enthalpies of the blowdown and feedwater streams, respectively.

### Example

Calculate the amount of blowdown and blowdown loss for the 20 Tph natural gas fired boiler operating at 25 bars. Boiler feedwater is supplied at 30 bars, 110°C. Additional information about the fuel flow rate and water chemistry is provided below.

- HHV of natural gas = 54,220 kJ/kg (40,144 kJ/m<sup>3</sup>)
- Fuel supply = 1,693 m<sup>3</sup>/hr (28 m<sup>3</sup>/min)
- Fuel cost = \$1.0/m<sup>3</sup>
- Conductivity for blowdown = 2,000 μmhos/cm
- Conductivity for feedwater = 100 μmhos/cm
- Makeup water temperature: 20°C

Blowdown mass flow rate is calculated from the information provided as follows:

$$\beta \approx \frac{\text{Feedwater Conductivity}}{\text{Blowdown Conductivity}} = \frac{100}{2,000} = 0.05$$

$$m_{\text{blowdown}} = \left( \frac{0.05}{1 - 0.05} \right) 20,000 = 1,052 \frac{\text{kg}}{\text{hr}} = 0.29 \frac{\text{kg}}{\text{s}}$$



Boiler blowdown thermal energy content and blowdown loss are calculated as follows:

$$Q_{bd\_boiler} = m_{blowdown} (h_{blowdown} - h_{feedwater}) = 0.29 \times (971.8 - 463.5) = 148 \text{ kW}$$
$$\lambda_{blowdown} = \left( \frac{Q_{bd\_boiler}}{m_{fuel} \times HHV_{fuel}} \right) \times 100 = \left( \frac{148}{1,693/3,600 \times 40,144} \right) \times 100 = 0.79\%$$

It should be noted that the control volume for the boiler blowdown loss calculation was the boiler itself. Nevertheless, in an actual industrial steam system, feedwater is first heated in a deaerator or feedwater heater and then sent to the boiler. Hence, from a system perspective, blowdown is actually replaced by make-up water which is at ambient conditions (and not at feedwater conditions). The total system loss for blowdown is calculated as follows:

$$Q_{bd\_system} = m_{blowdown} (h_{blowdown} - h_{makeup})$$
$$\lambda_{bd\_system} = \left( \frac{Q_{bd\_system}}{m_{fuel} \times HHV_{fuel}} \right) \times 100$$

### Example

For the previous boiler blowdown system analysis, calculate the overall system-based blowdown energy loss and the equivalent fuel energy cost associated with boiler blowdown. Assume that makeup water to the steam system is at 20°C.

System based boiler blowdown thermal energy content and blowdown loss are calculated as follows:

$$Q_{bd\_system} = m_{blowdown} (h_{blowdown} - h_{makeup}) = 0.29 \times (971.8 - 83.9) = 259 \text{ kW}$$
$$\lambda_{bd\_system} = \left( \frac{Q_{bd\_system}}{m_{fuel} \times HHV_{fuel}} \right) \times 100 = \left( \frac{259}{1,693/3,600 \times 40,144} \right) \times 100 = 1.37\%$$

The equivalent fuel energy cost for the system impact for blowdown can be calculated as follows:

$$K_{bd\_system} = m_{fuel} \times k_{fuel} \times \lambda_{bd\_system}$$
$$K_{bd\_system} = 1,693 \times 1.0 \times 0.0137 = \$23.2/hr$$
$$K_{bd\_system} = 23.2 \times 8,760 \approx \$203,180/yr$$

Figure 9 presents a graphical chart that provides quantitative information on the boiler blowdown thermal energy content for boilers operating at different pressures and different blowdown rates. A generic steam production rate of 100 Tph is used in this graph. The user can refer to Figure 9 for a quick estimation of the boiler blowdown energy content or can refer to the more detailed calculations as shown above.



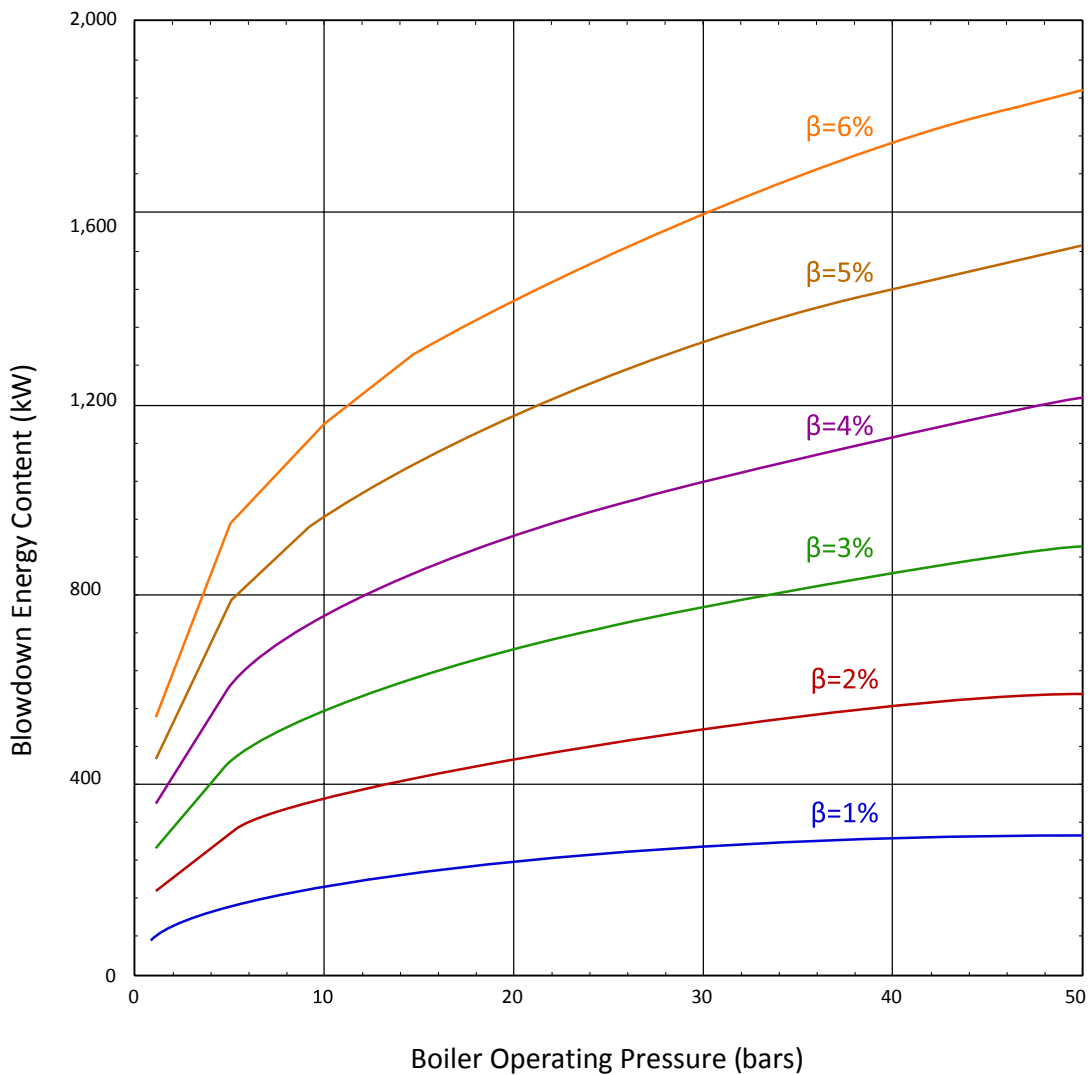


Figure 9: Boiler Blowdown Thermal Energy Content  
(100 Tph steam generation and feedwater at 20°C)

### 5.4.3. Stack Loss

While blowdown and shell losses are relatively small, stack loss almost always accounts for the largest proportion of boiler efficiency loss. Stack loss has two components — temperature and combustion (or excess air). Managing the stack loss is a critical factor in optimizing boiler operations and increasing boiler efficiency. Both components of stack loss are discussed in detail below.

#### 5.4.3.1. Flue Gas Temperature Component

A significant amount of fuel energy resides in the boiler flue gases. The temperature of the flue gas exhaust represents the amount of energy in the stack gas. The difference between the flue gas temperature and the combustion chamber inlet temperature (typically, ambient air temperature) is known as “Net Stack Temperature” and represents the amount of fuel energy that is lost in the stack. Assuming that the inlet air temperature is constant for a



boiler, a higher flue gas temperature implies a higher stack loss. This leads to lower boiler efficiency. Hence, boiler flue gas temperature is a critical parameter and should be carefully monitored and trended. There are several factors which affect the flue gas exhaust temperature. These include:

- Boiler design
- Heat recovery equipment
- Boiler load
- Fire side fouling
- Water side fouling

It is important to take these factors into account while evaluating optimizing boiler operations.

#### 5.4.3.2. Combustion Component

The combustion component of the stack loss depends on the unburned components of the fuel and amount of excess air (or flue gas oxygen).

The first principle of combustion management is to ensure that there is enough oxygen in the combustion process to ensure that all the fuel is combusted and there are no (minimal) combustibles in the stack.

The second principle of combustion management aims to restrain the amount of oxygen (air) in the combustion process. All the combustion air is heated up by fuel. The extra air (oxygen) added to the combustion zone enters the boiler at ambient temperature and exits the boiler at flue gas temperature. Ambient air contains ~4 parts nitrogen for every 1 part of oxygen. As a result, a large amount of nitrogen enters the combustion zone with excess air (oxygen) and a significant amount of fuel energy is spent on heating this excess air.

There are different methodologies available to calculate stack losses but every method is based on some form of the combustion model. For example, the ASME Power Test Code 4 clearly defines all the parameters, equations, measurements and instruments required to accurately calculate stack loss. That methodology is very detailed; instead of users having to use a detailed combustion model, this training manual provides two sources of calculating stack losses based on a combustion model developed by Dr. Greg Harrell for the US Department of Energy. They are:

- Stack loss tables (Table 4)
- Stack Loss calculator in the US DOE SSAT software (Figure 10)

The stack loss model assumes minimal (or no) combustibles in the stack and no condensate. The data required is: fuel type, flue gas temperature, flue gas oxygen content and inlet air temperature.



**Table 4: Stack Loss Table for Natural Gas**

(Reference: Combustion model developed by Greg Harrell, Ph.D., P.E.)

Stack Loss Table for Typical Natural Gas														
Flue Gas Oxygen Content Wet Basis [%]	Flue Gas Oxygen Content Dry Basis [%]	Comb Conc [ppm]	Stack Loss [% of fuel Higher Heating Value input]											
			Net Stack Temperature [ $\Delta^{\circ}\text{C}$ ]											
			{Difference between flue gas exhaust temperature and ambient temperature}											
			100	128	156	183	211	239	267	294	322	350	378	406
1.0	1.2	0	13.6	14.7	15.8	16.9	18.0	19.1	20.2	21.3	22.4	23.6	24.7	25.9
2.0	2.4	0	13.8	14.9	16.1	17.2	18.4	19.5	20.7	21.9	23.1	24.2	25.4	26.6
3.0	3.6	0	14.0	15.2	16.4	17.6	18.8	20.0	21.3	22.5	23.7	25.0	26.3	27.5
4.0	4.7	0	14.2	15.5	16.7	18.0	19.3	20.6	21.9	23.2	24.5	25.8	27.2	28.5
5.0	5.8	0	14.5	15.8	17.2	18.5	19.9	21.2	22.6	24.0	25.4	26.8	28.2	29.6
6.0	6.9	0	14.8	16.2	17.6	19.1	20.5	22.0	23.4	24.9	26.4	27.8	29.3	30.8
7.0	8.0	0	15.1	16.6	18.1	19.7	21.2	22.8	24.3	25.9	27.5	29.1	30.7	32.3
8.0	9.1	0	15.5	17.1	18.8	20.4	22.1	23.7	25.4	27.1	28.8	30.5	32.2	33.9
9.0	10.1	0	16.0	17.7	19.5	21.2	23.0	24.8	26.6	28.5	30.3	32.1	34.0	35.8
10.0	11.1	0	16.5	18.4	20.3	22.2	24.2	26.1	28.1	30.1	32.1	34.1	36.1	38.1
Actual Exhaust T [ $^{\circ}\text{C}$ ]			121	149	177	204	232	260	288	316	343	371	399	427
Ambient T [ $^{\circ}\text{C}$ ]			21	21	21	21	21	21	21	21	21	21	21	21

**Figure 10: Stack Loss Calculator in US DOE SSAT Software**

(Reference: Combustion model developed by Greg Harrell, Ph.D., P.E.)

**Steam System Assessment Tool  
Stack Loss Calculator**

Based on user inputs of Stack Temperature, Ambient Temperature and Stack Oxygen Content, an estimate will be provided of the heat loss from the boiler stack. Losses are expressed as a percentage of the heat fired.

Stack losses are related to SSAT Boiler Efficiency as follows:

$$\text{SSAT Boiler Efficiency} = 100\% - \text{Stack Loss (\%)} - \text{Shell Loss (\%)}$$

Shell Loss refers to the radiant heat loss from the boiler. Typically < 1% at full load, 1-2% at reduced load.

**Input Data**

Stack Gas Temperature ( $^{\circ}\text{F}$ )	200 $^{\circ}\text{C}$	Stack Temperature - Ambient Temperature = 180 $^{\circ}\text{C}$
Ambient Temperature ( $^{\circ}\text{F}$ )	20 $^{\circ}\text{C}$	

Stack Gas Oxygen Content (%)	5 %
------------------------------	-----

Note: Stack gas oxygen content is expressed on a molar or volumetric basis

**Results**

Estimated Stack Losses for each of the default fuels are as follows:

Natural Gas	18.3%
Number 2 Fuel Oil	14.0%
Number 6 Fuel Oil (Low Sulfur)	13.5%
Number 6 Fuel Oil (High Sulfur)	13.7%
Typical Eastern Coal (Bituminous)	12.0%
Typical Western Coal (Subbituminous)	13.6%
Typical Green Wood	24.7%



### Example

Estimate the stack loss on a 20 Tph operating boiler that has the following conditions:

- HHV of natural gas = 54,220 kJ/kg (40,144 kJ/m<sup>3</sup>)
- Fuel supply = 1,693 m<sup>3</sup>/hr (28 m<sup>3</sup>/min)
- Fuel cost = \$1.0/m<sup>3</sup>
- Stack temperature: 200°C
- Flue gas oxygen: 5%
- Negligible combustibles were found in stack gas analysis
- Ambient air temperature: 20°C

Input Data		
Stack Gas Temperature (°F)	200°C	Stack Temperature - Ambient Temperature = 180°C
Ambient Temperature (°F)	20°C	
Stack Gas Oxygen Content (%)	5 %	

Note: Stack gas oxygen content is expressed on a molar or volumetric basis

Results		
Estimated Stack Losses for each of the default fuels are as follows:		
Natural Gas	18.3%	$\lambda_{stack}$
Number 2 Fuel Oil	14.0%	
Number 6 Fuel Oil (Low Sulfur)	13.5%	
Number 6 Fuel Oil (High Sulfur)	13.7%	
Typical Eastern Coal (Bituminous)	12.0%	
Typical Western Coal (Subbituminous)	13.6%	
Typical Green Wood	24.7%	

Figure 11: Example Boiler – Stack Loss

### Example

Estimate the boiler efficiency (Indirect Efficiency Calculation) based on the different losses calculated in the previous sections on the 20 Tph natural gas operating boiler.

$$\eta_{boiler} = 100 - \lambda_{shell} - \lambda_{blowdown} - \lambda_{stack} - \lambda_{miscellaneous}$$

$$\eta_{boiler} = 100 - 0.50 - 0.79 - 18.3 - 0.0$$

$$\eta_{boiler} = 80.4\%$$

Note that the results from the indirect method of calculating boiler efficiency (80.4%) compare well with the direct method of calculating efficiency (80%). These values are within the uncertainty limits given the accuracy levels of the measurements.



## 5.5. Steam Generation Optimization Opportunities & BestPractices

There are several optimization opportunities in terms of steam generation, including:

- Minimize excess air
- Install heat recovery equipment
- Clean boiler heat transfer surfaces
- Improve water treatment
- Install an automatic boiler blowdown controller
- Recover energy from boiler blowdown
- Add/restore boiler refractory
- Minimize the number of operating boilers
- Investigate fuel switching
- Optimize deaerator operations

### 5.5.1. Minimize Excess Air

Proper combustion management requires adding enough oxygen to the combustion zone to burn all of the fuel but not adding too much air in order to ensure that the thermal energy loss is minimized. Combustion management evaluates the controlling methodology of the combustion process and begins with the measurements.

In boilers, fuel flow is typically controlled by steam header pressure. If steam pressure decreases the fuel flow controller will increase fuel flow in order for the boiler to generate more steam — restoring the steam pressure to the set point. Conversely, if steam pressure increases, fuel flow will be decreased to reduce steam production.

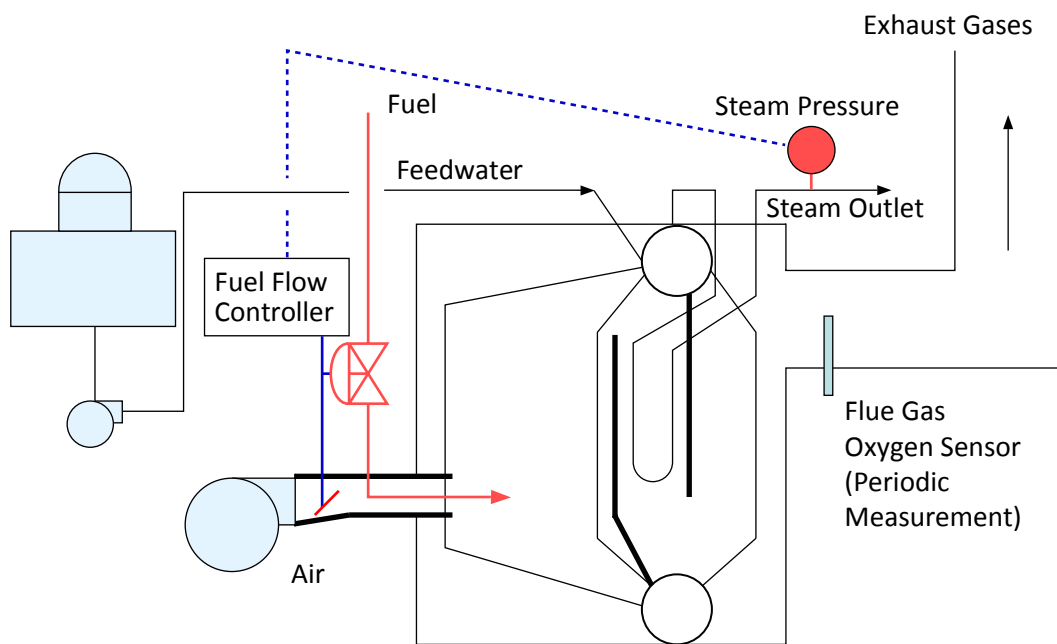
As the fuel flow into the boiler changes combustion, air flow must correspondingly change to maintain proper combustion. There are two primary forms of combustion control:

- Positioning control
- Automatic oxygen trim control

#### 5.5.1.1. Positioning Control

Combustion air flow control is accomplished by mechanically linking the air-flow control device (damper) to the fuel-flow control device. This is commonly called *positioning control* because the air-flow control device will have a position that is based solely on the position of the fuel-flow control device. Figure 12 provides a schematic of the *positioning control* mechanism. It should be noted that this control does not incorporate any active oxygen or combustibles measurements. Oxygen and combustibles measurements are only taken periodically to establish the position relationship between the fuel controller and the air controller.

“*Tuning the boiler*” is a BestPractice which should be carried out on a periodic basis in order to reestablish the positional relationship between the air and the fuel. This will ensure that combustion air will be minimized within the limits of *positioning control*.



**Figure 12: Positioning Control System**  
(Courtesy: US DOE Steam BestPractices End User Training Program)

#### 5.5.1.2. Automatic Oxygen Trim Control

With an *automatic oxygen trim control* methodology, combustion airflow is controlled by a combination of the fuel flow control valve and the flue gas oxygen monitor in the stack. Based on a burner manufacturers' combustion curve, a main air-flow control device (damper) is provided with a signal based on the fuel-flow control valve, as is the case with the *positioning control* methodology. In addition, the flue gas oxygen is measured continuously, thereby establishing a much tighter relationship in order to minimize the amount of excess air. This additional control reduces the amount of combustion air and thereby minimizes the amount of excess air. The *automatic oxygen trim control* method is more effective and efficient than the *positioning control* method. Figure 13 provides a schematic of the *automatic oxygen trim control* mechanism. In several installations, an *automatic oxygen trim control* is coupled with a variable speed driven (VSD) forced combustion fan which leads to additional electrical energy savings compared to a damper control, as is the case in the *positioning control* method.

Based on the best commercially available control technology, Table 5 provides flue gas oxygen (and excess air) operating levels for boilers operating with different fuels for the two types of control methodologies. Generally, higher flue gas oxygen content values correspond with low burner loads and low flue gas oxygen contents correspond with high burner loads. Excess air is noted in the table for reference purposes. Flue gas oxygen content is the measured value. Excess air is calculated from the fuel composition and the measured oxygen value.



Figure 13: Automatic Oxygen Trim Control System

(Courtesy: US DOE Steam BestPractices End User Training Program)

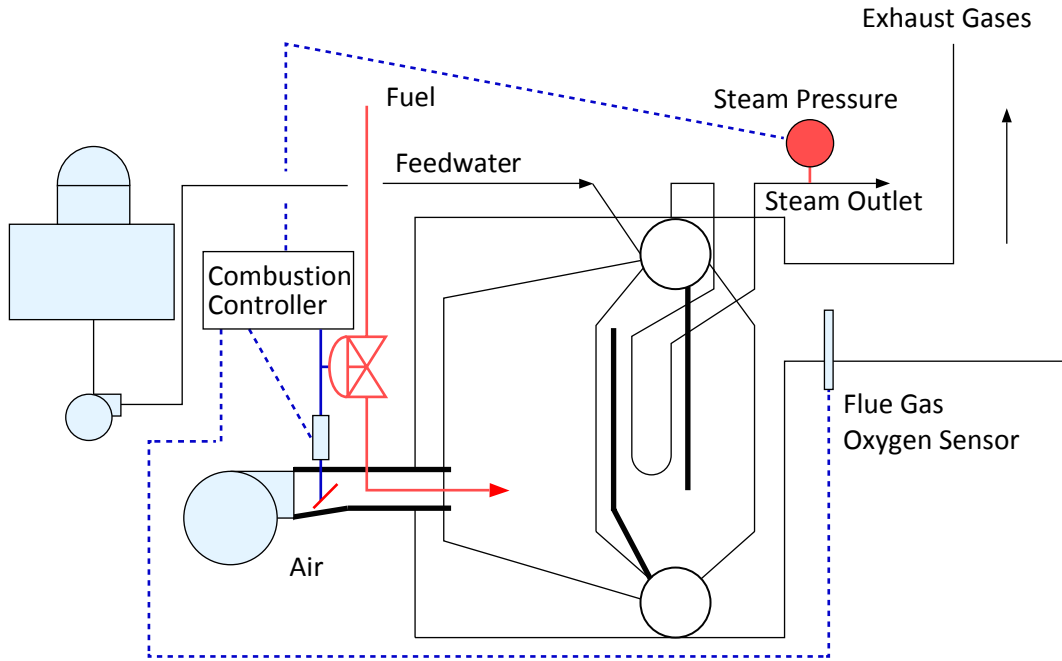


Table 5: Flue Gas Control Parameters

(Courtesy: US DOE ITP Steam BestPractices End User Training Program)

Typical Flue Gas Oxygen Content Control Parameters								
Fuel	Automatic Control Flue Gas O <sub>2</sub> Content		Positioning Control Flue Gas O <sub>2</sub> Content		Automatic Control Excess Air		Positioning Control Excess Air	
	Min. [%]	Max. [%]	Min. [%]	Max. [%]	Min. [%]	Max. [%]	Min. [%]	Max. [%]
Natural Gas	1.5	3.0	3.0	7.0	9	18	18	55
Numb. 2 Fuel Oil	2.0	3.0	3.0	7.0	11	18	18	55
Numb. 6 Fuel Oil	2.5	3.5	3.5	8.0	14	21	21	65
Pulverized Coal	2.5	4.0	4.0	7.0	14	25	25	50
Stoker Coal	3.5	5.0	5.0	8.0	20	32	32	65

In order to estimate the potential benefit of minimizing excess air it will be necessary to evaluate the total boiler operating costs and the current and new operating boiler efficiencies. The equation below calculates the cost savings for the energy savings opportunity.

$$\sigma = K_{boiler} \left( 1 - \frac{\eta_{current}}{\eta_{new}} \right)$$



where  $\sigma$  is the fuel cost savings,  $K_{boiler}$  is the current operating cost of the boiler,  $\eta_{current}$  and  $\eta_{new}$  are the current and new boiler operating efficiencies, respectively.

### Example

The 20 Tph natural gas-fired operating boiler has a positional controller that is periodically re-tuned. Estimate the annual energy cost savings opportunity for implementing an automatic oxygen trim controller for managing the excess air on the boiler. Neglect the shell and blowdown losses for the boiler efficiency calculations.

- HHV of natural gas = 54,220 kJ/kg (40,144 kJ/m<sup>3</sup>)
- Fuel supply = 1,693 m<sup>3</sup>/hr (28 m<sup>3</sup>/min)
- Fuel cost = \$1.0/m<sup>3</sup>
- Stack temperature: 200°C
- Flue gas oxygen: 5%
- Negligible combustibles were found in stack gas analysis
- Ambient air temperature: 20°C

The boiler operating cost was calculated in the earlier section as follows:

$$K_{boiler} = 1,693 \times 1.0 = \$1,693/hr$$

$$K_{boiler} = 1,693 \times 1.0 \times 8,760 = \$14,830,680/yr$$

Current stack loss was calculated from the US DOE SSAT Stack Loss calculator and is 18.3% for 5% flue gas oxygen, 200°C stack temperature and 20°C ambient temperature. Hence, the current boiler efficiency is  $\eta_{current}$  is 81.7%.

From Table 5, it can be observed that commercially available automatic oxygen trim controllers can control the flue gas oxygen within 3%. Assuming that the stack temperature does not change, the new stack loss is calculated to be 17.4%. Hence, the new boiler efficiency is  $\eta_{new}$  is 82.6%.

The energy cost savings for minimizing the excess air by implementing an automatic oxygen trim controller are calculated as follows:

$$\sigma_{ExcessAir} = K_{boiler} \times \left( 1 - \frac{\eta_{current}}{\eta_{new}} \right)$$

$$\sigma_{ExcessAir} = 14,830,680 \times \left( 1 - \frac{81.7}{82.6} \right)$$

$$\sigma_{ExcessAir} = \$161,593/yr$$





## 5.5.2. Install Flue Gas Heat Recovery Equipment

There are three main types of flue gas heat recovery equipment in industrial boilers. These are:

- Feedwater economizers
- Air preheaters
- Condensing economizers

The type of heat recovery equipment found in industrial boilers will depend upon the fuel being used and the corresponding boiler design. Almost all industrial boilers will (or should) have feedwater economizers. Most solid fuel boilers and fuels with significant moisture content will have air preheaters. A significant number of industrial boilers and power plant boilers will have both feedwater economizers and air preheaters. Boilers burning clean burning fuels (natural gas, methane, diesel, etc.) can benefit from condensing economizers, depending on the overall system heat requirements.

### 5.5.2.1. Feedwater Economizer

A feedwater economizer is a heat exchanger installed to transfer thermal energy from the flue gas into the boiler feedwater. This is the most common energy recovery component installed on boilers. Even if the boiler design does not have a feedwater economizer configured, it may be feasible to install a modular feedwater economizer in the stack of an existing boiler. State-of-the-art heat exchanger design and material technologies allow for minimal flue gas side pressure drop and good temperature approaches to maximize the heat recovery with minimal heat transfer area. Additionally, feedwater economizers are compact and typically do not present any major “real-estate” or size constraints.

### 5.5.2.2. Air Preheater

A combustion air preheater heats the combustion air by transferring energy from the flue gas in the stack. The heat exchange is identical to the feedwater economizer except that instead of the feedwater it is the combustion air being heated. The net result is a reduction in fuel usage and hence an increase in the boiler efficiency.

Due to the nature of heat transfer – air-to-air, air preheaters are large and will typically have a much larger pressure drop. Most industrial boilers with an air preheater will have an induced draft fan to overcome this pressure drop and to avoid significant back-pressure on the combustion chamber.

Additional care must also be taken to avoid reaching an exhaust flue gas temperature below the acid dew point. This minimum temperature limit depends on the sulfur content in the fuel. Condensation in the stack (or flue gas) would form sulfuric acid which is very corrosive and would lead to metal deterioration and a lower operational reliability of the boiler. In addition to sulfuric acid, further reduction in the stack gas temperature would lead to the formation of carbonic acid. This is not a major concern for short durations since carbonic acid is a weak acid but over time it will become an operational issue if the metallurgy is not properly configured for condensation in the stack gas.

### 5.5.2.3. Condensing Economizer

With water vapor being a product of combustion it typically stays in the gaseous state and exits the stack. Nevertheless, this water vapor contains a significant amount of energy which can be recovered if this water vapor is allowed to condense. There is commercially available



heat recovery equipment which has been specifically designed for clean burning fuels (natural gas, methane gas, propane, #2 fuel oil, etc.) to recover the latent heat of the water vapor from the flue gas. These units are typically referred to as condensing economizers.

Depending on the fuel, condensing economizers can improve boiler efficiency by more than 10%. To achieve condensation in the flue gas stream, flue gas temperatures should get below the dew point. This is typically 60°C for natural gas combustion and as the flue gas temperature drops more and more water vapor condenses, allowing for higher heat recovery.

It should be noted that since the dew point controls the condensation process in the flue gas, the heat in the plant should be of a low temperature. Condensing economizers can recover a large amount of heat but it is very low grade. Applications in industry that require a lot of low-grade heating such as food processing plants, steam plants with 100% make-up water, textiles, plant or district heating etc. are often good targets for condensing economizers.

Evaluation of condensing economizers will typically require a partial pressure-based combustion model; this is not within the scope of this training manual. Nevertheless, condensing economizer manufacturers and text books can provide charts of heat recovery that have been developed for specific clean burning fuels.

### **Example**

The 20 Tph natural gas-fired operating boiler used to have a feedwater economizer but it was removed for maintenance and the removal of scale build-up. The current the boiler has thus operated without the feedwater economizer for a few years. Estimate the annual energy cost savings opportunity for re-installing a feedwater economizer on the boiler. Neglect the shell and blowdown losses for the boiler efficiency calculations.

- HHV of natural gas = 54,220 kJ/kg (40,144 kJ/m<sup>3</sup>)
- Fuel supply = 1,693 m<sup>3</sup>/hr (28 m<sup>3</sup>/min)
- Fuel cost = \$1.0/m<sup>3</sup>
- Stack temperature: 200°C
- Flue gas oxygen: 5%
- Negligible combustibles were found in stack gas analysis
- Ambient air temperature: 20°C

The boiler operating cost was calculated in the earlier section as follows:

$$K_{boiler} = 1,693 \times 1.0 = \$1,693/hr$$

$$K_{boiler} = 1,693 \times 1.0 \times 8,760 = \$14,830,680/yr$$

Current stack loss was calculated from the US DOE SSAT Stack Loss calculator and is 18.3% for 5% flue gas oxygen, 200°C stack temperature and 20°C ambient temperature. Hence, the current boiler efficiency is  $\eta_{current}$  is 81.7%.

Based on previous operating (design) conditions, it is known that with the feedwater economizer in place, stack temperature is ~160°C. Using the Stack Loss Calculator, as shown in Figure 14, the new stack loss is calculated to be 16.3%. The new boiler efficiency is therefore  $\eta_{new}$  is 83.7%.

Input Data		
Stack Gas Temperature (°F)	160°C	Stack Temperature - Ambient Temperature = 140°C
Ambient Temperature (°F)	20°C	
Stack Gas Oxygen Content (%)	5%	

Note: Stack gas oxygen content is expressed on a molar or volumetric basis

---

Results	
Estimated Stack Losses for each of the default fuels are as follows:	
Natural Gas	16.3%

Figure 14: Example Boiler – Stack Loss Calculation with Feedwater Economizer

The fuel energy cost savings after installing a feedwater economizer are calculated as follows:

$$\sigma_{ExcessAir} = K_{boiler} \left( 1 - \frac{\eta_{current}}{\eta_{new}} \right)$$

$$\sigma_{ExcessAir} = 14,830,680 \times \left( 1 - \frac{81.7}{83.7} \right)$$

$$\sigma_{ExcessAir} \approx \$354,375/yr$$

### 5.5.3. Clean Boiler Heat Transfer Surfaces

Heat transfer surfaces get fouled over time. Fouling on the heat transfer surfaces leads to additional heat transfer resistance which leads to higher stack exhaust temperatures. As observed in the earlier sections, this leads to lower boiler efficiency because a significant amount of energy is left in the flue gases exiting the stack. There therefore needs to be a predictive and preventative maintenance procedure that is aimed at periodically cleaning the heat transfer surfaces in the boiler.

Fireside heat transfer fouling is fuel-dependent and for most gaseous and clean-burning fuels, it may be negligible or non-existent. When heavier liquids and solid fuels (coal, wood, black liquor, etc.) are used in the boiler, there is significant ash and carbon soot build up on the tubes of the boiler. This needs to be removed with an efficient soot-blowing system. Soot-blowers are lances with nozzles that use high pressure steam or compressed air to break the soot forming on the tubes. Industrial boilers with soot-blowers will have a timing-based periodic setup for soot-blowing in different sections (zones) of the boiler tubes. It is very important to ensure that this system is working correctly. A direct indicator of fireside fouling will be an increase in the stack gas exhaust temperature and trending it will provide valuable information on the effective performance of the soot-blowing system.

Waterside heat transfer fouling is controlled by boiler water chemistry and is a direct function of boiler pressure, feedwater quality and blowdown rate. Waterside fouling is “scale” on the tube surfaces that results in an increased heat transfer resistance. Scale has to be chemically or mechanically removed when the boiler is shut down. Scale leads to increased tube wall



temperatures and eventually a breakdown of the boiler tubes. Waterside fouling therefore has a direct impact on the reliability of boiler operations as well as the overall boiler efficiency. It is very important to perform inspections of boiler tubes for scale during the annual shutdown and undertake de-scaling of boiler tubes periodically.

Energy savings calculations using the stack loss calculator can be performed for justifying the cleaning of boiler heat transfer surfaces.

#### 5.5.4. Improve Water Treatment

Generally, feedwater quality is impacted most by the makeup water. Condensate is commonly the cleanest water in the steam system. Makeup water must be conditioned before it is added to the system. The makeup water treatment system can be improved resulting in improved makeup water quality.

Boiler make-up water has to be treated appropriately based on the water chemistry requirements for reliable boiler operations. Blowdown management depends on two factors: boiler operating pressure and water treatment. Ensuring the highest quality of make-up water available will reduce the amount of blowdown required. Reduction in the amount of blowdown leads to a proportional reduction in the thermal energy lost in the blowdown stream. Nevertheless, there could be a significant cost to improving water treatment if it requires additional infrastructure and the implementation of capital assets such as a demineralization system or a reverse osmosis system. In most industrial boiler systems, there will be a water chemist (or a contractor) who will be responsible for maintaining boiler water chemistry. It is best to work with them to ensure the optimum quality of water treatment necessary for the site. Common improvements to water treatment quality include changing from sodium-cycle softening to demineralization or to reverse osmosis conditioning.

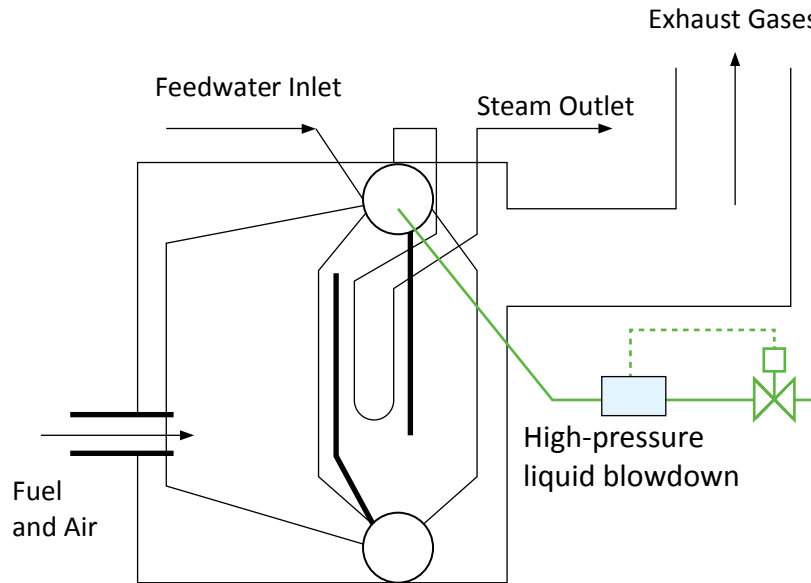
#### 5.5.5. Install an Automatic Boiler Blowdown Controller

There are two types of blowdown applied to industrial boiler systems: Surface blowdown and Bottom (Mud Drum) blowdown. Surface blowdown can be intermittent or continuous. Bottom blowdown is always intermittent and is carried out once a shift to remove heavier settled impurities. This optimization opportunity applies only to surface blowdown and, most specifically, to blowdown that is manually controlled. Boiler loads vary with time and, ideally, blowdown flow rate should change accordingly to maintain proper boiler water chemistry. Most of the time the control range (typically conductivity or TDS) for boiler water will be set by the water chemist and boiler operators will sample the water periodically to ensure that the boiler water control parameters are within the set range.

In most circumstances, manual blowdown control leads to excessive blowdown and this is a large energy penalty. Sometimes, however, manual blowdown is not enough and this can result in poor boiler water chemistry control leading to issues with reliable boiler operations. Installing an automatic boiler blowdown controller allows for the minimum and exact amount of blowdown that is required for reliable boiler operations, thereby reducing unnecessary energy losses. An automatic boiler blowdown controller monitors boiler water conductivity continuously, in real-time, and controls a modulating or an ON/OFF valve to maintain the required blowdown. This is shown in Figure 15 below.

**Figure 15: Automatic Boiler Blowdown Controller**

(Courtesy: US DOE ITP Steam BestPractices End User Training Program)



Preliminary energy and cost savings from the installation of an automatic boiler blowdown controller (and/or improving water treatment) can be calculated as follows:

$$Q_{bd\_savings} = (m_{blowdown\_current} - m_{blowdown\_new}) \times (h_{blowdown} - h_{makeup})$$

$$K_{bd\_savings} = \left( \frac{Q_{bd\_savings}}{\eta_{boiler} \times HHV_{fuel}} \right) \times k_{fuel} \times T$$

where  $m_{blowdown\_current}$  and  $m_{blowdown\_new}$  are calculated from the steam flow rates and blowdown percentage. T is the operating hours for calculating the savings over the period. For a more detailed analysis, a US DOE SSAT system type model will be required.

### 5.5.6. Recover Energy from Boiler Blowdown

Blowdown thermal energy recovery takes two forms and virtually all the energy lost in the boiler blowdown can be recovered using a combination of these two methodologies:

- Flash steam recovery
- Make-up water preheating

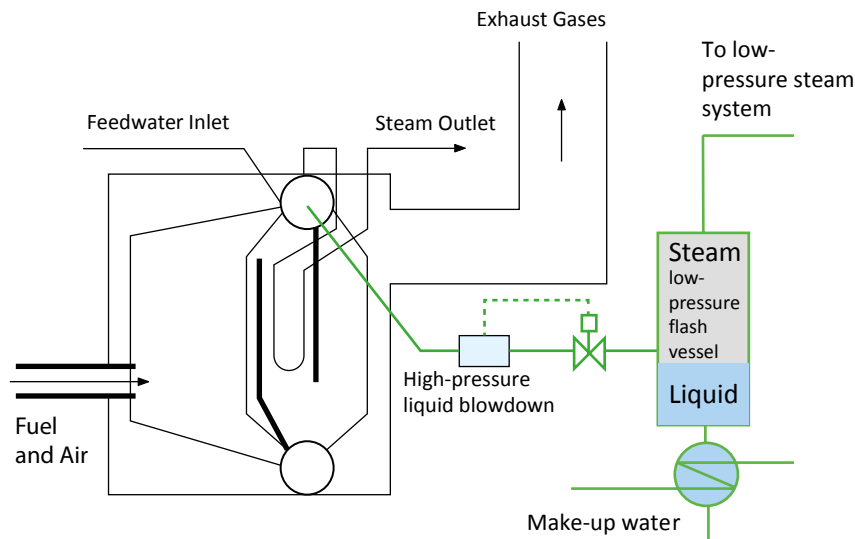
The high-pressure blowdown steam is first flashed into a pressure vessel (flash tank) operating at low-pressure (typically slightly above deaerator pressure). Part of the blowdown liquid flashes to steam at the lower pressure. This flash-steam is clean and can feed the low-pressure steam header or supply steam to the deaerator or feedwater heating system. The liquid that remains in the flash-vessel is at the saturation temperature ( $> 100^{\circ}\text{C}$ ) and can still be used to preheat make-up water in the make-up heat exchanger. The blowdown water



is eventually discharged from the system at a temperature very close to the make-up water (or ambient) temperature. The blowdown loss can be virtually eliminated with very simple, robust equipment. Figure 16 provides a schematic of the blowdown energy recovery system.

**Figure 16: Blowdown Energy Recovery**

(Courtesy: US DOE ITP Steam BestPractices End User Training Program)



The energy and cost savings possible with flash steam recovery and make-up water pre-heating was calculated as overall system impact in the “Blowdown Loss” section previously. Although manual hand calculations were presented in that section, a detailed steam system model, such as the US DOE SSAT, is typically required to accurately predict the energy savings.

From an equipment perspective, the flash tank is a very simple unit and can be acquired for little cost. Nevertheless, the heat exchanger must be carefully selected. The heat exchanger applied in this service must be capable of being cleaned because the blowdown stream can foul the heat exchange surface. Two types of heat exchangers perform well in this application:

- Shell-and-tube straight-tube heat exchanger with blowdown on the tube-side
- Plate-and-frame heat exchanger

### 5.5.7. Add/Restore Boiler Refractory

Boiler insulation and refractory aim to ensure the safety of plant personnel and to reduce shell losses via radiation and convection. External surfaces may need periodic repairs due to ambient conditions or damage during operations. Additionally, during annual inspections the refractory should be inspected for any failures, cracks and breaks. Thermal cycling or direct impingement of hot material may have led to a breakdown in the refractory. This opportunity falls under predictive and preventative maintenance BestPractices for reliable steam system operations. Plant personnel should use an infra-red thermal camera to search for hot spots (temperatures  $>70^{\circ}\text{C}$ ) and compare these images over time to see if any repair is necessary.

### 5.5.8. Minimize the Number of Operating Boilers

Shell losses are typically small (in magnitude) when compared to other industrial boiler losses. But they can add up to significant numbers when there are multiple boilers operating. These losses can also become excessive if one or some of the boilers are on “hot standby”. Typically, most industrial plants will operate with at least an “ $n+1$ ” redundancy, implying that there is at least one extra boiler available to produce steam (or on hot standby) than required to supply the total plant steam demand. This is mainly done to increase the reliability of operations and to ensure that production is not impacted due to any boiler trips or unforeseen breakdowns.

Typically, steam system savings opportunities and optimization in the plant may not lead to shutting down an operating boiler but this opportunity has to be investigated every time there is a change in the steam demand. There may be opportunities based on production cycles, seasonality, weekend/weekday and holiday operations, day/night operations; any of the afore-mentioned may impact the number of boilers operating in an industrial plant. Most often this opportunity is neglected due to the added complexity of turning ON and OFF a boiler and the amount of start-up time required. This can be an issue for large solid fuel-fired boilers but smaller boilers, especially those operating with natural gas, methane gas, etc., should be much more amenable to a quick start-up.

When analyzing this as a potential optimization strategy, a thorough risk analysis should be done to identify any major issues that may result in a drop in steam production for a finite period of time. This risk analysis should also outlay the potential monetary damage to the product and possible mitigation strategies. Additionally, the cost of additional controls or tell-tale instrumentation (alarms, temperature signals, pressure signals) should be taken into consideration when implementing this optimization strategy.

### 5.5.9. Investigate Fuel Switching

Fuel selection can influence operating costs due to differences in energy costs and boiler efficiencies. The fuel efficiency will generally be an influencing factor when changing fuel. Energy costs and maintenance expenditures may sometimes be offset but this will not be evident unless additional due diligence is taken for the optimizing opportunity. Additionally, environmental issues can become a significant concern associated with fuel selection. Each application will require an independent evaluation. Fuel switching does not necessarily imply the switching of fuels “completely”. Industrial steam generation plants may have multiple boilers operating and fuel switching could also imply:

- Shutting down a boiler operating with a certain fuel
- Reducing steam output of Boiler A working with Fuel 1 and correspondingly increasing output of Boiler B working with Fuel 2
- Dual or multi-fuel firing of any boiler and changing the ratios of the fuels firing the boiler

The cost savings from fuel switching can be calculated as follows:

$$\sigma_{\text{FuelSwitch\_savings}} = \text{Current Operating Cost} - \text{New Operating Cost}$$



$$\sigma_{\text{FuelSwitch\_savings}} = m_{\text{steam}} (h_{\text{steam}} - h_{\text{feedwater}}) \times \left( \frac{k_{\text{fuel}_1}}{\eta_{\text{boiler}_1}} - \frac{k_{\text{fuel}_2}}{\eta_{\text{boiler}_2}} \right) \times T$$

where  $k_{\text{fuel}_1}$  and  $\eta_{\text{boiler}_1}$  are the current fuel cost and boiler efficiency, respectively while  $k_{\text{fuel}_2}$  and  $\eta_{\text{boiler}_2}$  are the new fuel cost and boiler efficiency, respectively. The mass flow of steam switched is given by  $m_{\text{steam}}$  and  $T$  represents the time period being evaluated for the fuel switch.

### Example

Estimate the fuel switching opportunity / annual energy cost savings for switching 1 Tph of steam from the natural gas fired boiler ( $k_{\text{fuel}_1} = \$25$  per GJ;  $\eta_{\text{boiler}_1} = 80\%$ ) to heavy fuel oil fired boiler ( $k_{\text{fuel}_2} = \$18$  per GJ;  $\eta_{\text{boiler}_2} = 84\%$ ). The steam and feedwater enthalpies were obtained before and are as follows:

- $h_{\text{steam}} = 3,181$  kJ/kg
- $h_{\text{feedwater}} = 463.5$  kJ/kg

The cost savings from fuel switching can be calculated as follows:

$$\sigma_{\text{FuelSwitch\_savings}} = m_{\text{steam}} (h_{\text{steam}} - h_{\text{feedwater}}) \times \left( \frac{k_{\text{fuel}_1}}{\eta_{\text{boiler}_1}} - \frac{k_{\text{fuel}_2}}{\eta_{\text{boiler}_2}} \right) \times T$$

$$\sigma_{\text{FuelSwitch\_savings}} = 1,000 \times (3,181 - 463.5) \times \left( \frac{25}{0.80} - \frac{18}{0.84} \right) \times \frac{1}{10^6} \times 8,760$$

$$\sigma_{\text{FuelSwitch\_savings}} \approx \$234,000/\text{yr}$$

## 5.5.10. Optimize Deaerator Operations

The deaerator performs several functions in an industrial steam system. They include:

- Deaerating or removing dissolved oxygen from the feedwater (most important function)
- Preheating the make-up water
- May serve as a tank for mixing the returned condensate with make-up water
- Serving as a storage tank for feedwater and supplying the boiler feedwater pump

The deaerator operates at a fixed pressure. This pressure is dictated by the deaerator design. The main function of the deaerator – removal of dissolved oxygen from water – requires a stripping action. The stripping action is provided by the steam. Additionally, the steam pre-heats the make-up water which reduces the solubility of oxygen in the dissolved water further enhancing the stripping process. The deaerator requires a direct injection of live steam. The amount of steam used depends on:

- Deaerator pressure
- Amount of condensate returned and make-up water
- Temperature of condensate returned
- Temperature of make-up water
- Deaerator vent rate



As deaerator pressure is increased, more steam is needed and the amount of steam vented (from the vents) also increases. Nevertheless, if higher temperature condensate is being returned or if there is a waste heat recovery application that preheats the make-up water, then it may be beneficial to operate the deaerator at a higher pressure. A higher pressure operation will also require a smaller size deaerator for the same steam load. There have been several instances where processes change over time or are modified in industrial plants. This in turn may change the amount of condensate returned, the temperature of the condensate and the make-up water preheating. It is therefore important to evaluate deaerator operations and ensure that it is operating at the lowest possible pressure and deaerating with the highest efficiency possible.

Additionally, reducing deaerator pressure will reduce the feedwater inlet temperature to a feedwater economizer; this may help to reduce stack temperature, which may lead to higher boiler efficiency. Care must be taken to ensure that lowering feedwater temperature doesn't reduce the stack temperature below its acid dew point.

Calculating the energy and cost savings to be derived from this opportunity will require a detailed system model such as the US DOE SSAT.



## 6. STEAM DISTRIBUTION OPTIMIZATION OPPORTUNITIES

---

This section focuses on the steam distribution area and the optimization opportunities and BestPractices in an industrial steam system.

### 6.1. Overview

The steam distribution area is very important because it serves as the conduit for moving the steam from the generation area to the end-use area. Some industrial steam systems are very small and a steam distribution network may not exist in those plants. But in most industrial plants, steam is distributed over a wide network of headers. Steam is generated at a high pressure but the pressure may be reduced to supply different pressure headers. In some cases, there may be only a single pressure header and the steam pressure-reduced at each point of use. It should be noted that steam does not require any mechanical device (compressor, pump, etc.) to distribute it to the headers. The steam pressure serves as the driving force to distribute steam as and where it is required.

The main components of a steam distribution system include:

- Steam piping & fittings
- Pressure reducing stations
- Valves
- Insulation
- Safety relief valves
- Condensate traps
- Instrumentation (Pressure, Temperature, Flow)

From a process perspective, it is important to ensure that the process not only receives the correct amount of steam required but that it also receives it at the temperature and pressure specifications as required by the process. It should be noted that process requirements and end-uses can change over time but the distribution system may not. Hence, it is important to focus, evaluate and optimize the distribution system on a continuous basis. This is key

to reliable system operations. Although the generation area may be optimized and may be producing the steam that is required by the process, due to issues in the distribution system several problems for the process areas could arise, such as:

- Lack of steam pressure on the header near the end-user
- Insufficient amount of steam available on the header for the end-user
- Steam quality issues (wet steam entering process)
- Water hammer in the headers

The purpose of evaluating the steam distribution system on a continuous basis is to identify ways of optimizing the system for reliable operations (at the end-use) and to identify energy savings opportunities that would optimize the overall steam system.

## 6.2. Steam Distribution Optimization Opportunities & BestPractices

Optimizing the steam distribution system in an industrial plant requires focus on many different areas. These areas are fundamental in the field of energy management and generally result in attractive economics when savings opportunities are identified. These areas are also essential to the continued efficient and reliable operation of any steam system.

There are several optimization opportunities in the steam distribution area including:

- Repair steam leaks
- Minimize vented steam
- Ensure that steam system piping, valves, fittings and vessels are well insulated
- Isolate steam from unused lines
- Minimize flows through pressure reducing stations
- Reduce pressure drop in headers
- Drain condensate from steam headers

### 6.2.1. Repair Steam Leaks

Steam is an expensive utility from which significant economic losses can result when steam is lost from the system through leaks. Steam leaks occur everywhere, most commonly:

- Flanges and gasketed joints
- Pipe fittings
- Valves, stem and packings
- Steam traps
- Relief valves
- Pipe failures

Steam leaks from pipe failures can be a major source of steam loss in an industrial plant. These typically present a “safety issue” if they are in close proximity to areas frequented by plant personnel . Steam leaks in remote locations such as pipe racks can result in economic losses in that they do not tend to get noticed and remain there forever.



Steam trap failures also account for a large portion of the leaks within an industrial plant; these will be handled in the chapter on “Condensate Recovery” later in the manual. Generally, steam trap failures are more difficult to observe than pipe failures, especially in closed condensate systems.

A continuous maintenance program based on finding and eliminating steam leaks is essential to the efficient operation of a steam system. Most times, such maintenance programs are questioned in the industrial plant as regards their cost-effectiveness and overall impact on operations. But it has been observed in all instances that having a steam leaks management program can be very beneficial both economically and from a reliable operations perspective for an industrial plant.

Typically, the steam loss magnitude through a leak is difficult to determine unless a proper procedure is followed. Nevertheless, an order of magnitude of the steam leak is all that is necessary to plan the repair strategy. Several theoretical and empirical methods have been developed to provide a gross estimate of the steam loss including, but not limited to:

- US DOE SSAT model
- Plume height measurement
- Napier’s choked flow equation
- Pitot tube measurement in the field
- Ultrasonic techniques with manufacturers’ protocols
- Thermodynamic mass and energy balance methodologies

Figure 17 shows the approximate leakage flow of saturated steam through a sharp-edged orifice for a given operating pressure and the orifice size.

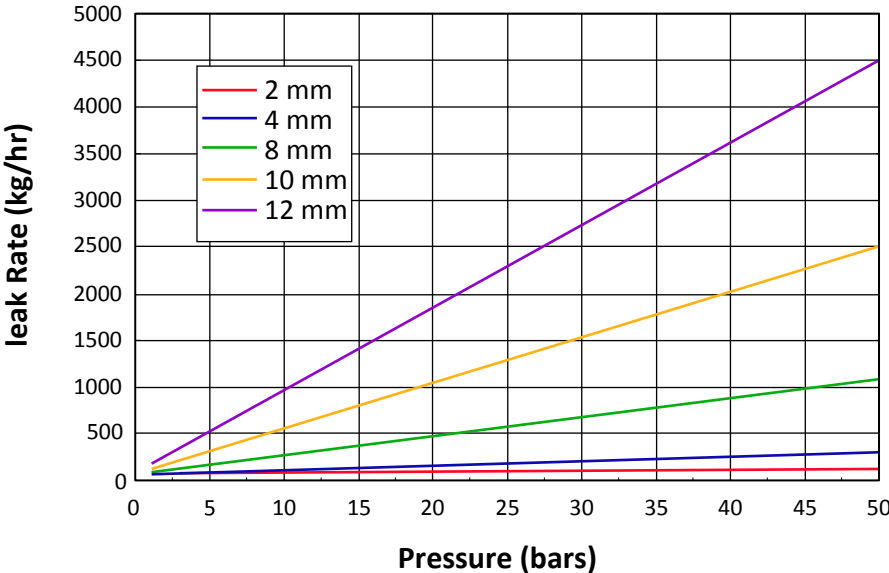


Figure 17: Steam Leakage Rate through an Orifice

Figure 17 was developed from Napier’s choked flow equation. This equation is as follows:

$$m_{steam} = 0.695 \times A_{orifice} \times P_{steam}$$

where the  $m_{steam}$  is steam leakage flow rate (in kg/hr),  $A_{orifice}$  is the area of the orifice through which the steam is leaking (in mm<sup>2</sup>) and  $P_{steam}$  is the header pressure (in bars absolute). It should be noted that this relationship is only valid for choked flow conditions, which is when the exit pressure is less than 0.51 times the header pressure.

**Example**

A steam leak of a ~4 mm diameter orifice was found on the 2 bar header. Estimate the steam leakage flow rate and the annual energy cost savings associated with repairing this steam leak. The steam cost calculated in the “Generation” area was \$91.67 per tonne of steam. Assume that this steam leak exists on the steam header that is operating all year round (8,760 hours).

From the information given:

$$A_{orifice} = \frac{\pi}{4} d_{orifice}^2 = \frac{\pi}{4} \times (4.0)^2 = 12.56 \text{ mm}^2$$

$$P_{steam} = 2 + 1.013 = 3.013 \text{ bar (absolute)}$$

Then using Napier’s choked flow equation:

$$m_{steam} = 0.695 \times A_{orifice} \times P_{steam}$$

$$m_{steam} = 0.695 \times 12.56 \times 3.013$$

$$m_{steam} \approx 26.2 \text{ kg/hr}$$

The steam leakage flow rate estimated is 26.2 kg/hr and the annual energy cost savings associated with repairing this steam leak are as follows:

$$\sigma_{steamleak} = m_{steam} \times k_{steam} \times T$$

$$\sigma_{steamleak} = 26.2 \times \frac{91.67}{1,000} \times 8,760$$

$$\sigma_{steamleak} \approx \$21,000/yr$$

Steam leaks occur over time and it is important to realize that repairing steam leaks once and then forgetting about them is not the way to optimize a distribution system. It is anticipated that a continuous steam leaks management program is put in place that can continuously monitor and repair steam leaks periodically.

**6.2.2. Minimize Vented Steam**

Steam venting should not be confused with steam leaks. Steam venting happens when safety relief valves or other pressure controlling devices vent steam to the ambient from the steam header. This typically happens due to steam unbalance in the headers when more steam is being generated than is needed by the end-use processes. The energy and cost savings potential can be very significant based on what the impact fuel may be. Venting



of steam most often happens automatically as steam header pressure limits are reached. Sometimes steam venting is done by manually opening a “vent” or “sky” valve due to upset or trip conditions on the process side.

Combined Heat and Power (CHP) industrial plants that have steam turbines in operation may see steam venting more often than others, especially if there are only backpressure steam turbines driving process loads or operating under fixed power generation (or steam flow) conditions. Industrial plants with condensing turbines will almost never have steam venting unless the operating maximum capacity limits for the condensing turbine(s) have been reached. In several instances, an economic analysis based on marginal fuel and electric costs has to be done to determine the real value of vented steam. Most times it will be found that venting steam is not economical for CHP units, but there could be instances such as peak demand times, when power production is far more beneficial than the marginal cost of steam that is vented. More on this topic will be discussed in the section on “Combined Heat & Power Opportunities”.

Calculations for the energy and cost benefits of minimizing (or eliminating) steam venting follow the same procedure as mentioned in the “Steam leaks” section and will not be repeated here.

### **6.2.3. Ensure that Steam Piping, Valves, Fittings and Vessels are well Insulated**

Insulation is another area that should be subject to continuous maintenance and should be appraised periodically in all industrial plants. It must be noted that although insulation is being discussed in the “steam distribution” area, it in fact impacts on all the steam areas. The main reason for discussing it in the “distribution area” is because it has the greatest impact here.

Insulation is extremely important on steam systems for the following reasons:

- Plant personnel safety
- Minimizing energy losses
- Maintaining steam conditions for process end-use requirement
- Protecting equipment, piping, etc. from ambient conditions
- Preserving overall system integrity

There are several reasons for damaged or missing insulation, including:

- Missing insulation due to maintenance activities
- Missing / damaged insulation due to abuse
- Damaged insulation due to accidents
- Normal wear and tear of insulation due to ambient conditions
- Valves and other components not insulated because no insulation was specified at design

The most common areas of missing or damaged insulation include:

- Steam distribution headers
- Valves
- Inspection man-ways

- End-use equipment
- Storage tanks and vessels
- Condensate return lines

A first-order determination of the amount of energy lost and cost savings from uninsulated (or poorly insulated) areas in the steam system will provide the basis for determining the need for undertaking an insulation project. The main factors that affect the amount of energy lost from uninsulated or poorly insulated areas are:

- Process fluid temperature
- Ambient temperature
- Surface area exposed to ambient
- Wind speed
- Operating hours
- Thermal conductivity of pipe (or equipment) material
- Heat transfer resistance of insulation material (if any)

A first-order heat transfer model can be developed and used to determine the convective (natural and/or forced) and the radiant heat transfer energy losses from all the areas that are either uninsulated or poorly insulated. Nevertheless, this can be cumbersome and will require heat transfer correlations which will vary based on geometry and the modes of convective heat transfer – natural or forced. Nevertheless, an analysis must be completed to determine the energy and cost savings as well as an economic insulation thickness. Many empirical and computerized tools are available to aid in the evaluation of insulation projects. One such tool is the 3EPlus<sup>®</sup> insulation evaluation software developed by the North American Insulation Manufacturers Association (NAIMA).

The 3EPlus<sup>®</sup> Insulation Thickness Computer Program is an industrial energy management tool used to simplify the task of determining energy and cost savings as well as an economic insulation thickness. Economic insulation thickness refers to the amount of insulation that provides the lowest life cycle cost for the system.

3EPlus<sup>®</sup> has been pre-populated with ~30 insulation materials including their thermal properties. Additionally, several different materials and jackets (with different emissivity) are in-built in the software to allow the user to use drop-down menus to select specific materials for their applications. Lastly, different geometries and applications can be modeled in the software. The capabilities of this software tool are demonstrated in the example below.

### **Example**

A 10m long section of 10 bar steam header is observed to be uninsulated. The header has a nominal diameter of 10 inches (25.4 cm) with a steam temperature ~362°C. Estimate the economic impact of insulating this steam header.

Figure 18 shows the input screen for calculating the energy loss from this uninsulated header.

Figure 19 shows the “Heat Loss per Hour” results screen from the 3EPlus<sup>®</sup>.



Figure 18: 3EPlus® Input Screen

3E Plus v4.0  
File Edit Units Help

< Back Calculate

**ENERGY** ENVIRONMENT ECONOMICS OPTIONS

**ENERGY**

**INSULATION THICKNESS**  
Surface Temperatures  
Condensation Control  
Personnel Protection

**COST OF ENERGY**  
Bare and Insulated Surfaces

Insulation Thickness

Item Description: 10 bar header from HP-LP Turbine System Application: Pipe - Horizontal System Units: ASTM C585

Calculation Type: Heat Loss Per Hour

Process Temp: 362 °C Ambient Temp: 20 °C NPS Pipe Size: 250

Wind Speed: 1.0 m/s

Insulation Layers

Add Delete

#	Type	Name	Lock Thickness	Thickness, mm
	Base Metal	Steel		
1	Insulation	Calcium Silicate BLK+PIPE, Type I, C533-07	Fix	76
	Jacket Material	0.1 Aluminum, oxidized, in service		

Figure 19: 3EPlus® Results Screen

3E Plus v4.0  
File Edit Units Help

< Back Calculate

**ENERGY** ENVIRONMENT ECONOMICS OPTIONS

**ENERGY**

**INSULATION THICKNESS**  
Surface Temperatures  
Condensation Control  
Personnel Protection

**COST OF ENERGY**  
Bare and Insulated Surfaces

Heat Loss Per Hour Report

Item Description: 10 bar header from HP-LP Turbine System Units: ASTM C585

Geometry Description: Steel Pipe - Horizontal

Bare Surface Emittance: 0.8 Nominal Pipe Size: 250 mm

Process Temp: 362.0 °C Ave. Ambient Temp: 20.0 °C Ave. Wind Speed: 1.0 m/s

Relative Humidity: N/A Dew Point: N/A

Condensation Control Thickness: N/A

Outer Jacket Material: Aluminum, oxidized, in service Outer Surface Emittance: 0.1

Insulation Layer 1: Calcium Silicate BLK+PIPE, Type I, Thickness: 76.0 mm

Append To Audit Browse...

Variable Insulation Thickness	Surface Temp (°C)	Heat Loss (W/m)	Efficiency (%)
Bare	360.0	8449.00	
Layer 1	57.2	347.70	95.89





The energy savings can be calculated as follows:

$$Q_{\text{saved\_Insulation}} = (\text{HeatLoss}_{\text{bare}} - \text{HeatLoss}_{\text{insulated}}) \times \text{Length}$$

$$Q_{\text{saved\_Insulation}} = (8,449 - 347.7) \times 10 = 81.0 \text{ kW}$$

where  $\text{HeatLoss}_{\text{bare}}$  and  $\text{HeatLoss}_{\text{insulated}}$  are values obtained from the 3EPlus® program. The cost savings can now be calculated based on cost of fuel ( $k_{\text{fuel}}$ ), boiler efficiency ( $\eta_{\text{boiler}}$ ), HHV of the fuel ( $\text{HHV}_{\text{fuel}}$ ) and the operating period (T) as follows:

$$\sigma_{\text{insulation}} = \frac{Q_{\text{saved\_Insulation}} \times k_{\text{fuel}} \times T}{\eta_{\text{boiler}} \times \text{HHV}_{\text{fuel}}}$$

$$\sigma_{\text{insulation}} = \frac{81 \times 1.0 \times 3,600 \times 8,760}{0.80 \times 40,144}$$

$$\sigma_{\text{insulation}} \approx \$77,895/\text{yr}$$

Insulation repair and maintenance in industrial plants may be outsourced and most times it is cost effective to have several areas that need insulation repair dealt with at the same time. Plant personnel should therefore periodically undertake an insulation appraisal (audit) of their plant and identify the major areas that would benefit from upgrading or adding insulation. This should be a continuous activity done on a periodic basis and will ensure that the steam system is always well insulated and has minimal heat losses.

#### 6.2.4. Isolate Steam from Unused Lines

As industrial processes change, steam demand varies and sometimes steam is no longer required for a particular process, facility or air-handler. Nevertheless, the steam lines are still in place and contain live steam until the first block (isolation) valve of the process end-use. There are also times when certain equipment is decommissioned and will never be used again but the steam lines to that equipment are still connected to the live steam headers and are hot. This same situation can occur during seasonal variations when the plant goes from a heating mode (in winter) to a cooling mode (in summer) where the steam lines are still running hot – adding more load to the cooling system. There are innumerable such circumstances that can exist in industrial plants and they all lead to significant energy and cost savings opportunities that a steam systems optimization should identify via a systematic analysis of the distribution system in conjunction with the process end-uses.

From an energy and cost savings perspective, isolating steam from unused lines would:

- Eliminate heat transfer losses
- Eliminate steam leaks
- Eliminate any condensate formed in the headers which may lead to water hammer
- Reduce maintenance requirements of steam system components in that section



In addition, there could be downstream processes which may get impacted by the quality of steam and there could be production impacts which may result in additional steam being required and thereby increasing the costs of operations.

All the methodologies described earlier can be used to determine the energy and cost savings that would result from isolating steam from unused lines; they will not be repeated here.

### 6.2.5. Minimize Flows through Pressure Reducing Stations

Typically, steam is generated at a higher pressure and distributed on different lower pressure headers or via a single pressure header. Nevertheless, there are pressure reducing stations which drop the steam pressure appropriately. As steam flows through the pressure reducing valve, it expands (with pressure reduction) and temperature reduces. Hence, steam going through a pressure reducing valve does not lose its energy content ( $kJ/kg$ ) because it is an “isenthalpic” process - the steam enthalpy does not change. Nevertheless, the entropy of steam does change, which implies that the steam’s ability to do shaft work reduces. This is not a big issue when the industrial plant does not have steam turbines. Nevertheless, each industrial plant should evaluate the possible use of steam turbines if there exists a continuous and significant steam flow through pressure reducing valves. The exact handling of the turbines and the economic benefit will be covered later in the section on “Combined Heat and Power”.

This optimization opportunity has been listed in this area to ensure that steam is generated in industrial plants at the proper pressure required and unnecessary inefficiencies do not arise due to steam expansion. A pressure reducing station will need periodic maintenance and most often it is not insulated. Additionally, the valve stem and packings become the frequent sites of steam leaks due to thermal cycling and movement of the stem due to variable steam demands on the process side.

### 6.2.6. Reduce Pressure Drop in Headers

This optimization opportunity stems from the fact that over time, processes change and steam use varies. Additionally, the distribution system efficiency reduces due to wear and tear and there is an increase in the pressure drop in the steam header. In a saturated steam system, this implies a reduction in the steam supply temperature which may directly impact the process. Alternatively, it may mean more steam is required due to a reduction in the steam enthalpy from heat losses.

There is no industry standard per se for pressure drop on headers but there are three main reasons for pressure drop increases on steam headers. They are:

- Increase in steam demand, which leads to more steam flow on the same header
- Reduction in steam header pressure
- Condensation and two-phase flow in steam header
- A combination of the above

As steam flow increases, steam flow velocity increases and pressure drop is proportional to the square of the velocity. While carrying out a steam systems optimization it is important to understand the design of the headers and the design steam loads on these headers. Typically, steam design flow velocities can be anywhere from 15-25 m/s. Excess of these velocities will result in a significant increase in noise and structural vibrations, especially near bends and supports.

As the steam header pressure is reduced, due to the lower density (higher specific volume) of steam, the steam velocity increases for the same mass flow rate. This will lead to excessive pressure drops, as explained above. In several industrial plants, a common recommendation for energy savings is to drop the boiler operating pressure. This should be done with extreme caution and unless the steam header has been designed with excess capacity (which is very rare), this recommendation should not be implemented.

Condensation in saturated steam occurs as soon as a small amount of heat is lost from the header due to missing insulation, etc. This implies that the header now has two-phase flow conditions. If the condensate trap system is not working properly, this will imply that steam and water are traveling in the header with the same velocity. This compounded with the flow regime (based on amount of water) can lead to huge pressure drops and significant water hammer issues. More on this topic is provided in the section below.

The optimization opportunity for reducing pressure drop in steam headers would possibly include evaluation of one or more of the following strategies:

- Increasing header size by replacing the current header
- Adding another header for the same pressure level
- Reducing steam demand on the header by shifting steam demand to other pressure levels
- Upsizing valves and/or re-trimming
- Eliminating any flow restrictions in the headers
- All of the optimization strategies in this section such as:
  - Eliminating steam leaks
  - Improving insulation
  - Ensuring proper operation of condensate drains, etc.

### 6.2.7. Drain Condensate from Steam Headers

A steam distribution system can be extensive and there could be miles of steam piping in an industrial plant. Even when the steam lines are well insulated there is a certain amount of heat loss that exists which could lead to condensation in the steam headers especially for saturated steam systems. In certain systems where carryover is an issue from the boilers the problem is exacerbated and there is two-phase flow right from the generation area.

Most industrial plants will have condensate (steam) traps to remove any and all condensate that is formed in the steam header. Removal of condensate from the steam header ensures a highly reliable steam system operation and results in the following BestPractices:



- Steam header does not have excessive pressure drop
- No water hammer results in the steam header due to two-phase flow regime
- Process end-use receives dry steam
- Major equipment such as turbines receive dry steam
- No corrosion, pitting or erosion on pipe fittings, valves, etc.

Condensate that is drained from the steam headers can be flashed in a flash tank / separator vessel to a lower pressure steam header. The remainder of the condensate can either be sent back to the boiler plant directly or to a cascade condensate return system.

Some industrial plants have excellent condensate removal from the steam headers but may not be returning condensate and instead may dump it. There is both an energy and an economic loss to dumping condensate removed from the steam headers. This evaluation will be undertaken in the section on “Condensate Recovery”. Nevertheless, it is important to identify potential opportunities in the steam distribution area where condensate can and should be collected and returned back to the boiler plant.





# 7

## 7. STEAM END-USE OPTIMIZATION OPPORTUNITIES

---

Industrial steam end-use is varied and even the most basic of processes differ from one industry to another. As a result it is difficult to cover the entirety of steam end-uses in a simple training manual. Nevertheless, steam end-use is the main reason for having a steam system in an industrial plant and should not be neglected. Enough due diligence should be given to study and understand end-use because optimizing steam in end-use can provide significant benefits both from the perspective of fuel energy and cost savings as well as production and yield improvements. Plant personnel working in steam systems in industrial plants should be trained to understand how steam is used in their specific plants. This will allow them to optimize their steam systems for their specific plant operations.

### 7.1. Steam Balance Overview

Steam demands take many different forms in industrial plants. In general, steam provides the source of heat to the process. Most of the industrial processes will require a certain mass flow rate of steam which will correspond to a thermal heat load or duty (kW). But there are certain processes in industry which require both mass flow (heat duty) and volume flow of steam. These are typically devices which require a certain steam velocity to perform the end-use functions in the industrial plant. Please note that steam turbines are not considered as end-users of steam and are not covered in this section. They will be covered separately in the section on “Combined Heat and Power” later. Some of the steam end-use components are listed below. This is not a comprehensive list but provides general guidance.

Steam end-uses which are specified and designed based on mass flow (heat duty) of steam are:

- Heat exchangers
- Dryers
- Evaporators
- Reboilers
- Reformers



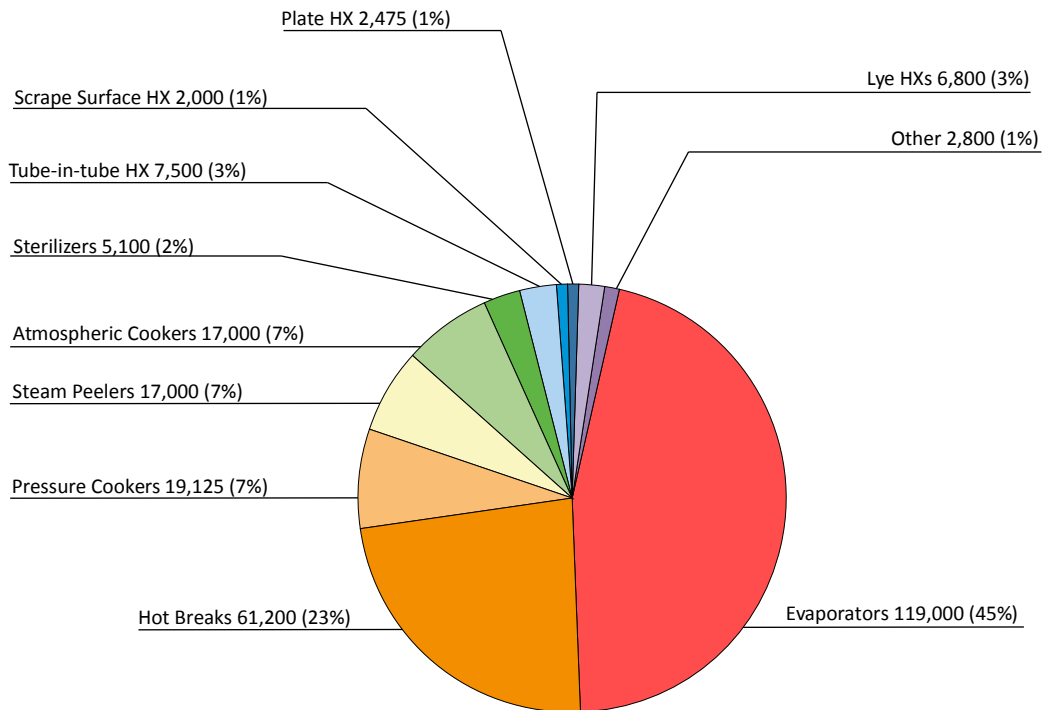
- Absorption chillers
- Humidifiers
- Preheat / reheat air handling coils

Steam end-uses which are specified and designed based on volume flow and mass flow (heat duty) of steam are:

- Steam jet ejectors / eductors
- Stripping columns
- Distillation towers
- Thermocompressors

For any steam systems optimization analysis, it is important to understand how much steam is used by each end-user in the industrial plant. This information can be gathered on an overall steam system level (as shown in Figure 20) or can be gathered for each individual pressure header level or by each individual area within an industrial plant. In most instances it is difficult to create such a steam end-use distribution pie chart because sub-metering and flowmeters may not be available at every end-user. It is recommended that plant personnel understand operations and together with design information be able to assign steam demands (and heat duties) to the end-uses based on process load conditions. This methodology will significantly aid in developing an overview of the steam end-use and identifying the major end-uses that one needs to focus attention on while undertaking an industrial steam systems optimization. The examples in this section provide some guidelines as to determining steam flows in processes using the fundamental principles of mass and energy balances.

**Figure 20: A Typical Steam End Use Pie Chart for a Food and Beverage Industry**  
(Note that numbers represent steam use in *kg/hr*)



**Example**

A shell-and-tube heat exchanger heats 600 liters/min of water from 25°C to 75°C. Saturated steam at atmospheric pressure is used for heating. Condensate exits the heat exchanger at 100°C. Calculate the heat duty and the amount of steam required for this indirect heat exchange process.

The heat transferred to the water is calculated as follows:

$$Q_{water} = m_{water} \times C_p \times (T_{out} - T_{in})$$

$$Q_{water} = \frac{600}{60} \times 4.183 \times (75 - 25) = 2,091 \text{ kW}$$

From an energy balance this heat is supplied by the steam and so it can now be written as:

$$Q_{water} = Q_{steam} = m_{steam} \times (h_{steam} - h_{condensate})$$

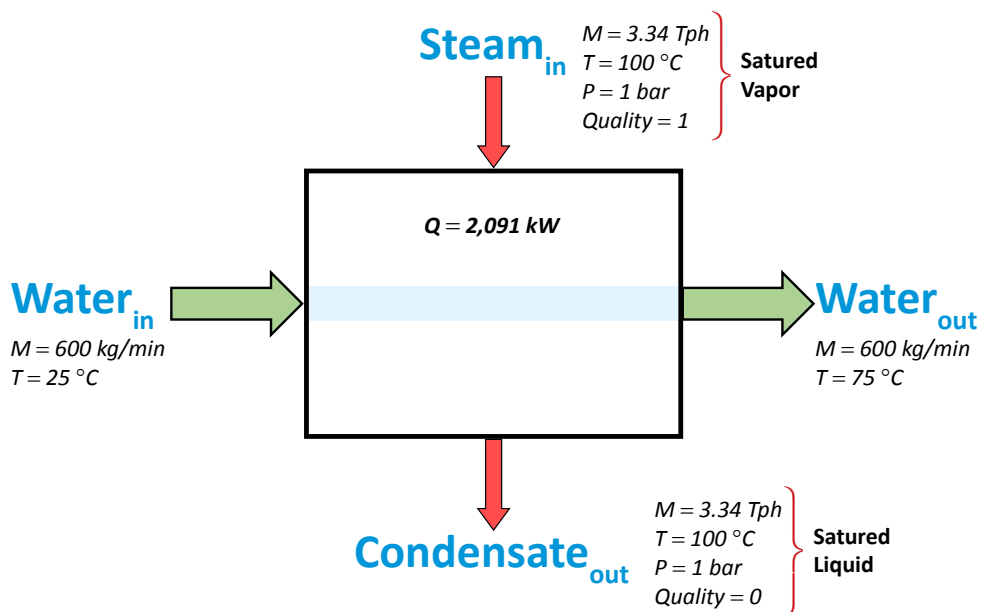
where  $h_{steam}$  (2,676 kJ/kg) is the enthalpy of saturated steam at atmospheric pressure and  $h_{condensate}$  (419 kJ/kg) is the enthalpy of condensate at 100°C (from steam tables).

$$Q_{water} = 2,091 = m_{steam} \times (2,676 - 419)$$

$$m_{steam} = \frac{2,091}{2,257} = 0.927 \text{ kg/s} = 3.34 \text{ Tph}$$

Figure 21 schematically shows the heat exchanger, heat duty and the different flows.

Figure 21: Steam / Water Indirect Heat Exchange



**Example**

Saturated steam at atmospheric pressure is directly injected in a vessel to heat water from 25°C to 75°C. The process requires 600 liters/min of heated water. Calculate the amount of steam required for this direct heat exchange process.



Water flow into the vessel ( $m_{water\_in}$ ) and steam flow ( $m_{steam}$ ) are not known. The conservation of mass equation can be written as follows:

$$m_{water\_out} = m_{water\_in} + m_{steam}$$

Since no shaft work is done in the vessel, the conservation of energy equation can be written:

$$m_{water\_out} \times h_{water\_out} = m_{water\_in} \times h_{water\_in} + m_{steam} \times h_{steam}$$

where  $h_{steam}$  (2,676 kJ/kg) is the enthalpy of saturated steam at atmospheric pressure;  $h_{water\_in}$  (104.8 kJ/kg) is the enthalpy of water entering the vessel at 25°C; and  $h_{water\_out}$  (314 kJ/kg) is the enthalpy of water leaving the vessel at 75°C (from steam tables).

Inputting the known values in these equations and solving them simultaneously provides the information about the unknowns.

$$m_{water\_out} = m_{water\_in} + m_{steam} = \frac{600}{60} \times \frac{974.9}{1,000} = 9.75 \text{ kg/s}$$

$$m_{water\_out} \times h_{water\_out} = m_{water\_in} \times h_{water\_in} + m_{steam} \times h_{steam}$$

$$9.75 \times (314) = m_{water\_in} \times (104.8) + m_{steam} \times (2,676)$$

$$m_{water\_in} \times (104.8) + m_{steam} \times (2,676) = 3,061.5$$

**Note:**

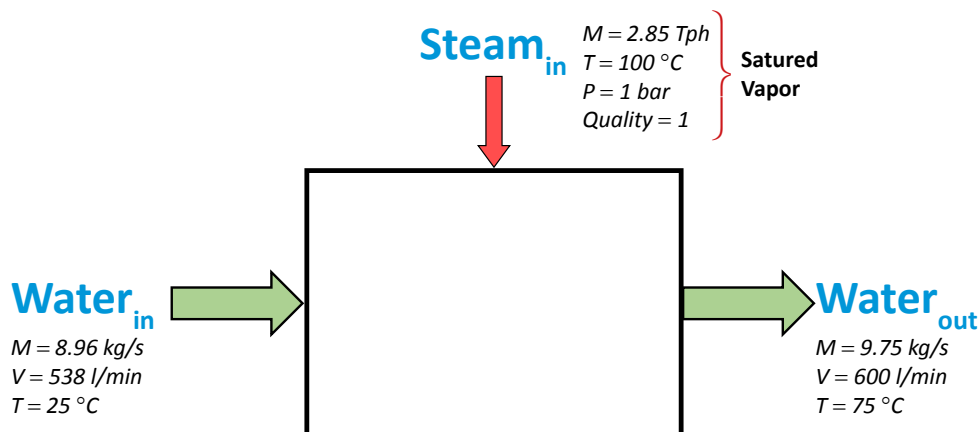
$$m_{steam} = 9.75 - m_{water\_in}$$

$$m_{water\_in} = 8.96 \text{ kg/s} = \frac{8.96}{1,000} \times 1,000 \times 60 = 539 \text{ litres/min}$$

$$m_{steam} = 0.793 \text{ kg/s} = 2.85 \text{ Tph}$$

Figure 22 schematically shows the direct heat exchange process and the different flows.

Figure 22: Steam / Water Direct Heat Exchange





## 7.2. Steam End-Use Optimization Opportunities & Best Practices

As mentioned earlier, it is extremely difficult to cover end-uses as are specific to industrial processes and plants. General methods are therefore described, in order to understand steam end-use and identify optimization opportunities. Additionally, quantifying the benefits of optimizing steam end-use opportunities is presented here. There is no doubt about the fact that process integration will lead to overall energy system optimization of the plant and the benefits will be far-reaching. But extreme care has to be taken and significant due-diligence must be completed before implementing these opportunities because these opportunities could impact process parameters adversely if applied incorrectly. This is an unfortunately common occurrence in industrial plants and often results in a loss of reputation on the part of the technology when in fact it was rather the case of the technology being misapplied in the specific application.

In the classic configuration, the main strategy for optimizing steam usage in end-use processes is to eliminate or reduce the amount of steam used by that process. This implies that improving the process efficiency eliminates inappropriate steam usage. The optimization strategy then focuses on using steam at as low a pressure as possible, which would allow power generation while reducing pressure. Lastly, the optimization strategy would aim to shift all or part of the steam demand to a waste heat source. One other configuration of this last step would be to upgrade low pressure (or waste) steam to supply process demands that would have otherwise used much higher pressure steam.

### Example

A process oven requires 2,000 m<sup>3</sup>/min of ambient air at 20°C to be heated to 80°C. This is currently achieved using 2 bar saturated steam. Figure 23 provides information about the process schematically. Estimate the energy savings opportunity if waste heat from an adjoining process can be used to preheat the ambient air to 40°C.

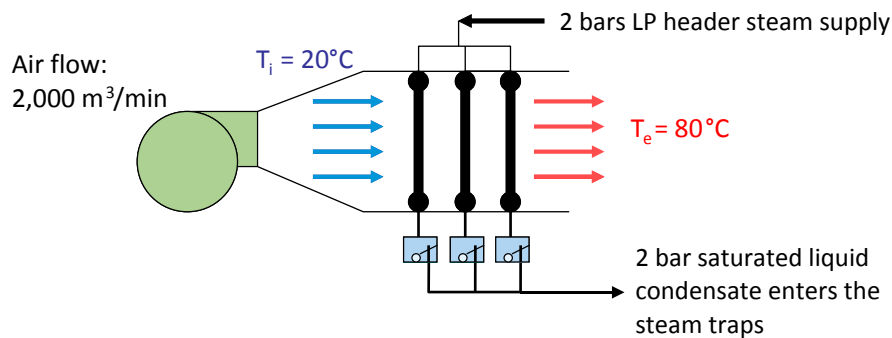


Figure 23: Steam Coil Air Heater (Current Operation)

The heat transferred to the air is calculated as follows:

$$Q_{air_1} = m_{air} \times C_p \times (T_{out} - T_{in})$$

$$Q_{air_1} = V_{air} \times \rho_{air} \times C_p \times (T_{out} - T_{in})$$

$$Q_{air_1} = \frac{2,000}{60} \times 1.188 \times 1.006 \times (80 - 20) = 2,391 \text{ kW}$$



where  $Q_{air_1}$  is the heat transferred to the air by the steam in the current operation;  $V_{air}$  is the volume flow rate of air;  $\rho_{air}$  is the density of air;  $C_p$  is the specific heat of air and  $T_{out}$  and  $T_{in}$  are the outlet and inlet temperatures of air, respectively.

In the optimized configuration, air is preheated to  $40^\circ\text{C}$  using a waste heat source from a nearby process. The heat transferred to air from steam in this optimized configuration is calculated as follows:

$$Q_{air_2} = m_{air} \times C_p \times (T_{out} - T_{in})$$
$$Q_{air_2} = V_{air} \times \rho_{air} \times C_p \times (T_{out} - T_{in})$$
$$Q_{air_2} = \frac{2,000}{60} \times 1.188 \times 1.006 \times (80 - 40) = 1,594 \text{ kW}$$

where  $Q_{air_2}$  is the heat transferred to the air by the steam in the optimized configuration in which air is preheated from a waste heat source;  $V_{air}$  is the volume flow rate of air;  $\rho_{air}$  is the density of air;  $C_p$  is the specific heat of air and  $T_{out}$  and  $T_{in}$  are the outlet and inlet temperatures of air in the optimized configuration, respectively.

Note that the savings in the amount of heat transferred by the steam is the difference between  $Q_{air_1}$  and  $Q_{air_2}$ , which is equivalent to 796 kW. This amount of energy savings can be converted to amount of steam saved as follows:

$$m_{steam\_saved} = \frac{(Q_{air_1} - Q_{air_2})}{(h_{steam} - h_{condensate})}$$
$$m_{steam\_saved} = \frac{796}{(3,181 - 561.5)}$$
$$m_{steam\_saved} = 0.304 \text{ kg/s} = 1.094 \text{ Tph}$$

where  $h_{steam}$  is the enthalpy of steam entering the steam coil air heater and  $h_{condensate}$  is saturated condensate (at 2 bars) leaving the steam coil air heater.

The equivalent cost savings can be calculated as follows:

$$\sigma_{steam} = m_{steam\_saved} \times k_{steam} \times T$$
$$\sigma_{steam} = 1,094 \times \frac{91.67}{1,000} \times 8,760$$
$$\sigma_{steam} \approx \$878,000/\text{yr}$$

This same analysis can be also carried out with a detailed steam system model such as the US DOE SSAT software. Nevertheless, it is important to undertake first-order due-diligence studies for prioritizing optimization opportunities in the end-use area. Most often, significant additional due diligence will be needed before implementing optimization opportunities that involve process integration.

## 8. STEAM CONDENSATE RECOVERY OPTIMIZATION OPPORTUNITIES

---

This section focuses on the condensate recovery area and the optimization opportunities and BestPractices in an industrial steam system.

### 8.1. Overview

Once steam has transferred its thermal energy it forms condensate. This condensate has to be continuously removed for the process to continue in the industrial plant. Condensate is not a waste stream but is the purest form of water (distilled) in the industrial plant. It has a significant amount of economic value, because:

- Condensate is much hotter than make-up water and therefore has significant thermal energy
- Condensate does not require any chemical water treatment other than condensate polishing
- If collected, condensate does not need to be sewerred and the sewer stream does not need to be quenched for any thermal limitations on sewer discharge.

The main metric for determining how an industrial plant is performing in the area of condensate recovery is to determine how much of the available condensate is actually returned to the boiler plant. The amount of available condensate is the amount of steam that is used in indirect heat exchange processes and condensing turbines. This calculation is typically represented as a ratio of amount of condensate returned to the amount of steam produced. Depending on the industrial plant, some of which can contain multiple headers, this ratio is also calculated at each header level and then for the overall steam plant.

Condensate recovery is considered to be good when it exceeds 80%. Depending on the original industrial plant design and size of the plant, condensate recovery can be significantly lower and this becomes a major area of steam systems optimization. Sometimes industrial process constraints such as possibility of condensate contamination in a process heat exchanger may dictate that condensate should not be returned to the boiler plant. This has to be evaluated on a case-by-case basis and will be discussed further later in this section.



The main components of a condensate recovery system include:

- Steam traps
- Condensate piping & fittings
- Flash tanks
- Receivers
- Pumps
- Lift stations
- Polishers & filters

Steam traps are an integral and cardinal part of a condensate recovery system. They will therefore be discussed in detail here.

## 8.2. Steam Traps

Steam traps are always a subject of major concern in reliable steam system operations. They are most often neglected due to a lack of resources on the part of the plant maintenance teams and their expertise and knowledge on steam traps and their operations. Steam traps serve several vital operating functions for a steam system but the most important are:

- During start-up, they allow air and large quantities of condensate to escape
- During normal operation, they allow collected condensate to pass into the condensate return system, while minimizing (or eliminating) loss of steam

There are different kinds of steam traps and therefore functionality and principles of operation must be understood by specifying design engineers, plant operations and maintenance teams. All industrial steam plants should have an effective steam trap management program. Although steam trap failures may not always result in energy loss per se, they almost always result in system operation problems and reliability issues. System debris, improper sizing and improper application are most common causes of steam trap failures in industrial plants.

There are several types of steam traps along with variations and combinations of types. The most common traps (shown with a \*) are classified on the principles of operation as follows:

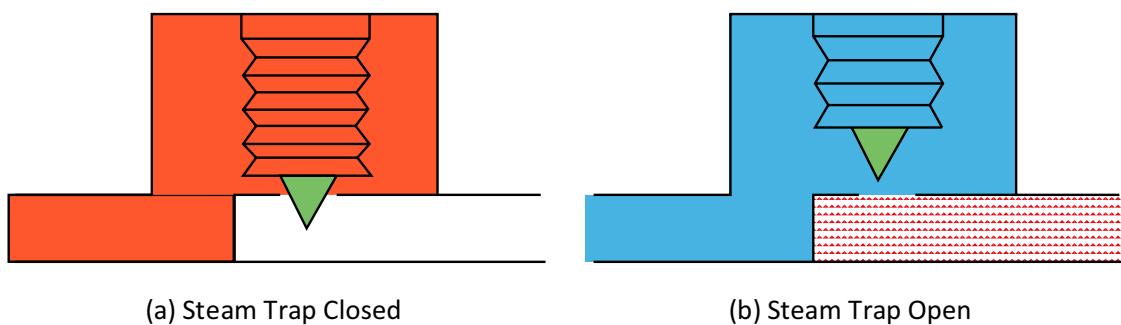
- Thermostatic Traps
  - Bellows\*
  - Bimetallic\*
- Mechanical Traps
  - Ball Float
  - Float and Lever
  - Inverted Bucket\*
  - Open Bucket
  - Float and Thermostatic\*
- Thermodynamic Traps
  - Disc\*
  - Piston
  - Lever
- Orifice Traps
  - Orifice Plate
  - Venturi Tube



### 8.2.1. Thermostatic Traps

A thermostatic steam trap operation is based on a certain temperature difference. Generally, the actuation results from an internal component expanding (or bending) when temperature increases — and contracting (or straightening out) when temperature decreases. When the trap internals are hot the thermostatic trap valve is closed. When the trap internals are cool the thermostatic trap valve is open.

Figure 24a shows steam entering the steam trap from the bottom left. An internal component such as a sealed bellows (or a bi-metallic strip) will expand (or bend) with temperature increase, thus closing the trap with a plug at the bottom of the mechanism. Then, as shown in Figure 24b, when sub-cooled condensate enters the steam trap the mechanism will contract, raising the plug at the bottom of the mechanism, allowing condensate or condensate and flash steam to flow out of the trap.



**Figure 24: Functioning of Thermostatic Steam Trap**  
(Courtesy: US DOE Steam BestPractices End User Training)

An important operational point associated with a thermostatic steam trap is that the trap internals must cool to a temperature that is less than the saturated steam temperature before the trap will open. Saturated steam and saturated condensate can exist in the trap at exactly the same temperature. At this point, the trap may not open. The trap will only open after the condensate has sub-cooled below a certain temperature. Typically, the traps will need a 5-20°C temperature difference for the traps to open.

### 8.2.2. Mechanical Traps

These traps work on the fundamental principle of buoyancy. The most common traps are:

- Float and Thermostatic (F&T)
- Inverted bucket

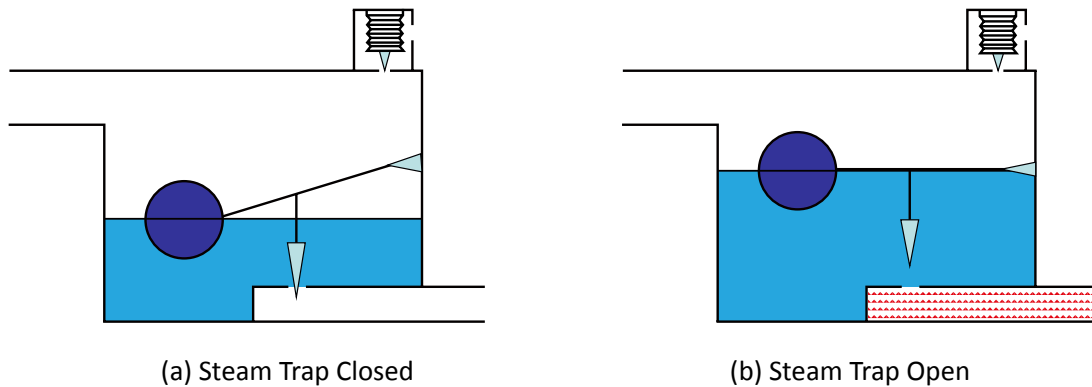
#### 8.2.2.1. *Float and Thermostatic (F&T) Traps*

As the name suggests, the F&T trap is a combination of two types of traps – float and thermostatic. The float is arranged so that condensate enters a reservoir in the trap. The outlet valve is actuated by a float mechanism and opens as the condensate level increases in the reservoir. This type of trap allows condensate to exit the system immediately after it forms making it an excellent selection for heat exchanger service and other applications where condensate



back up has to be prevented at all costs. The valve closes as the condensate level drops in the reservoir. Figure 25a shows the trap in the closed configuration and Figure 25b shows the trap in the open configuration.

It should be noted that only liquid can exit the float type trap and the mechanism will not allow air or non-condensable gases to exit. Hence, in industrial applications, a float type steam trap will always be coupled with a thermostatic element trap. The thermostatic element is mainly there for start-up conditions and the removal of air and non-condensables. This combined arrangement is known as an F&T trap.



**Figure 25: Functioning of F&T Mechanical Steam Trap**  
(Courtesy: US DOE Steam BestPractices End User Training)

### 8.2.2.2. *Inverted Bucket Traps*

An inverted bucket trap is another very commonly used mechanical trap that works on the principle of buoyancy. An upside-down bucket serves as the float. When the trap body and bucket are filled with condensate the bucket sinks. The outlet valve opens and condensate is removed. Both saturated and/or subcooled condensate can be removed by this trap. Once all the condensate is removed, steam enters the trap under the bucket. This pushes the bucket up, closing the outlet valve. Figure 26a represents the inverted bucket trap in the closed configuration. Figure 26b represents the inverted bucket trap in the open configuration.



**Figure 26: Functioning of Inverted Bucket Mechanical Steam Trap**  
(Courtesy: US DOE Steam BestPractices End User Training)

### 8.2.3. Thermodynamic Traps

Thermodynamic traps work on the Bernoulli principle and function identically to airfoils. The absolute pressure reduces as the velocity increases for a given substance in a control volume. This differential pressure can cause a disk to close an opening and function as a valve. One type of thermodynamic steam trap has a thin solid metal disk in a control chamber. Condensate enters the control chamber under the metal disk and pushes the disk up. Condensate is then removed via an annular gap made between the disk seat and the trap body. As steam starts flowing, the velocity of steam across the annular gap is high compared to the static condensate. This results in an area of low-pressure locally while there is a high-pressure area on the top of the metal disk. This forces the disk to seat and closes the trap. Figure 27a represents the thermodynamic trap in the closed configuration. Figure 27b represents the thermodynamic trap in the open configuration. This trap has an intermittent operation; the type is also used for small condensate loads.

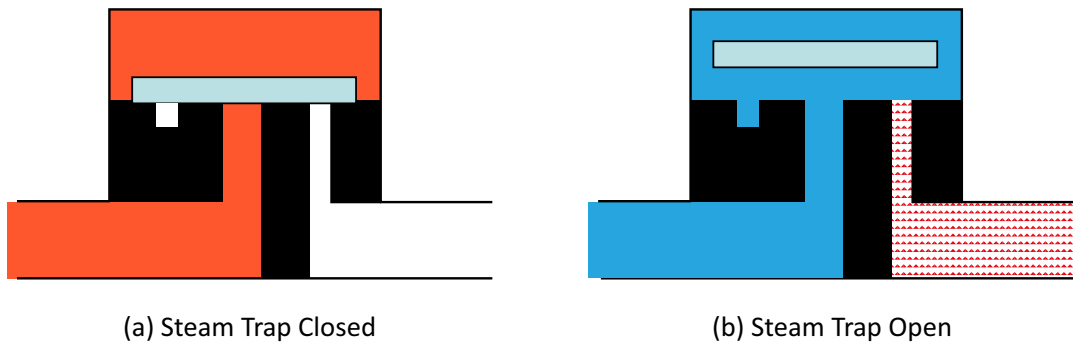


Figure 27: Functioning of Disk-type Thermodynamic Steam Trap  
(Courtesy: US DOE Steam BestPractices End User Training)

### 8.2.4. Orifice Traps

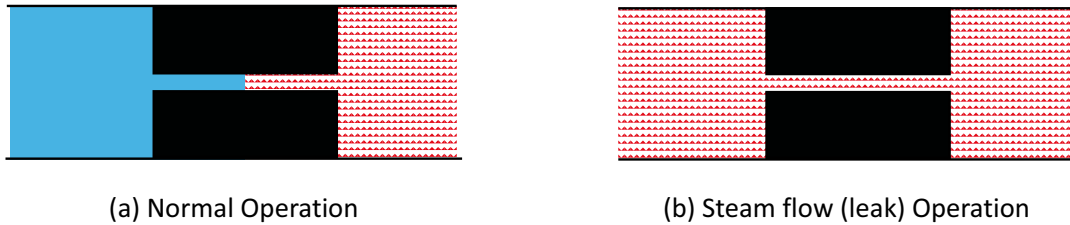
Orifice steam traps work on the principle that steam and condensate have extremely different volumetric properties. Orifice traps do not have any moving parts but rely on a restricting orifice, small diameter short tube, or a Venturi-type nozzle as the primary working component. The density of condensate is significantly greater than the density of steam. This fact allows a significant amount of condensate to pass through a very small opening (such as an orifice) and a minimal amount of steam to pass through the same opening. As condensate passes through the orifice, the pressure drop causes the condensate to generate flash steam. This flash steam serves as a form of a regulating valve for additional condensate / steam flow to pass through the trap.

The orifice traps have no moving parts and this is the biggest advantage of this trap over the other traps. This advantage implies minimal maintenance for the traps. In industrial steam systems that are not clean, this type of trap can become easily plugged by debris such as corrosion particulate, dirt, etc. Hence, some care has to be taken to periodically clean them.

It is critical to properly size orifice traps. If the trap is sized larger than necessary, significant amounts of live-steam will be lost to the condensate system. If the trap is sized smaller than necessary, condensate will backup into the system. These traps also work best when the



steam load is continuous and steady. Intermittent and cyclical steam loading can create operational issues related to either steam venting or condensate back-up. Figure 28a represents the thermodynamic trap in a normal operating configuration. Figure 28b represents the thermodynamic trap in the open (steam leak) configuration.



**Figure 28: Functioning of Orifice type Steam Traps**  
(Courtesy: US DOE Steam BestPractices End User Training)

### 8.3. Condensate Recovery Optimization Opportunities & BestPractices

Optimizing condensate recovery and its associated peripherals in an industrial plant can focus on many different areas. These areas are fundamental in the field of energy management and generally result in attractive economics when savings opportunities are identified. These areas are also essential to the continued efficient and reliable operation of any steam system.

There are several optimization opportunities in the steam distribution area, including:

- Implement an effective steam-trap management and maintenance program
- Recover as much as possible of the available condensate
- Recover condensate at the highest possible thermal energy
- Flash high pressure condensate to make low pressure steam

#### 8.3.1. Implement an Effective Steam-Trap Management and Maintenance Program

It is vitally important to have an effective steam trap management and maintenance program in an industrial plant. There can be several hundreds of steam traps in large plants and this steam trap population should be checked periodically to ensure it is operating properly. It is necessary to inspect every steam trap in the facility and determine how it is performing at least once a year. There are many different types of traps that function based on different principles. In order to investigate the steam traps it is important to understand how each type works. Hence, these inspections should be completed by trained personnel that understand the operation of steam traps and the steam system in general. Steam trap functionality should be assessed through the use of appropriate instruments like ultrasonic sensors and thermometers.

Steam traps fail in two major modes that have a significant economic and/or operational impact:

- Failed-Open
- Failed-Closed



A failed-open steam trap allows “live” steam to discharge from the system and so becomes a steam leak. A failed-closed trap does not remove condensate and it backs up in the upstream equipment. If this occurs in a process heat exchanger, production processes will be heat duty limited. If this trap serves a steam distribution header, then it could result in water hammer and damage components. Even a well-maintained steam system will typically experience a 10% trap failure in a 1-year period. If unchecked, this can translate into significant economic losses and operational issues to the system.

The assessment results should be compiled in a database that includes results for the trap:

- Good and working properly
- Failed-open and leaking steam
- Failed-open and blowing to ambient
- Failed-closed

A steam loss estimation for each failed leaking trap should be provided in the assessment. An excellent method of establishing the maximum steam loss through a failed trap is to complete an orifice calculation (see Napier’s equation). This will calculate the maximum steam loss for a particular trap. Uncertainty in this flow arises since it is not clear if there are internal obstructions to this flow. However, an order-of-magnitude steam loss estimate is generally sufficient to allow repair prioritization to occur.

There are several methodologies and techniques available in the industry for investigating steam trap performance. These are:

- Visual
- Acoustic
- Thermal
- Online real time monitoring

Typically, using one method alone is unlikely to provide a conclusive answer to the proper operation of the steam trap. Hence, a combination of the above methods is recommended. Additionally, since proper training and a good understanding of trap operations is a pre-requisite for inspecting steam traps, out-sourcing this activity on a periodic basis is a very good option. Most steam trap manufacturers and vendors will offer a steam trap audit service at minimal or no charge to the industrial plant.

Maintaining a steam trap database is absolutely essential for an effective steam trap management program. This database should contain, at the very minimum, the following fields:

- Trap tag number
- Location
- Trap type
- Model number
- Manufacturer
- Date when the trap was last checked for performance
- Date when the trap was installed (or re-installed after failure)
- Cause of trap failure
- Name of person who installed or replaced the failed trap
- Potential economic loss if trap fails open
- Potential production issues if trap fails open
- Potential production issues if trap fails closed
- Tell-tale signs of trap failed open
- Tell-tale signs of trap failed closed



Unless a detailed steam trap assessment is conducted at an industrial plant, it is difficult to potentially quantify the benefit of a steam trap management program. Nevertheless, historically and statistically it has been proven time and again that steam traps fail and that if they are not replaced or repaired they can be a source of significant energy waste, a cause of production woes and affect system reliability adversely.

The US DOE SSAT tool offers a very high level gross estimate of the potential energy and cost savings possible by implementing an effective steam trap management and maintenance program. This is based on historic failure rates of traps, number of traps in the plant and the last time a steam trap assessment followed by repair and/or replacement of traps was conducted in the plant.

### 8.3.2. Recover as Much as Possible of Available Condensate

Condensate is produced after steam has transferred all its thermal energy and condensed into water. There is a significant amount of thermal energy still associated with the condensate. Every unit of condensate recovered implies one less unit of make-up water required. Hence, returning additional condensate:

- Reduces the energy required in the deaerator
- Reduces make-up water
- Reduces chemicals for water treatment
- Reduces quenching water needed for sewers
- May reduce blowdown.

Optimizing condensate recovery begins with an evaluation of the current amount of condensate returned. Condensate returned should be evaluated based on different header levels. In large industrial plants which have an extensive distribution of steam system and a multitude of steam end-uses, condensate recovery depends on the following factors:

- Contamination levels
- Cost of recovery equipment
- Cost of condensate piping

Commercial technology is now available that can monitor contaminant levels in condensate real-time. These technologies have been very successfully implemented in industrial plants to aggressively collect condensate from all possible avenues including those areas which may have a probability of contaminated condensate. Their functionality is based on monitoring a certain contaminant level or conductivity of condensate and once those levels are exceeded, then a dump valve opens to sewer the condensate and simultaneously shuts off the return to the boiler plant. Every situation needs to be evaluated on its own merit and application. Sometimes it may not be cost effective to collect a small amount of condensate at a high risk of contaminating the boiler feedwater system.

The cost of recovery equipment and piping will depend on the physical location of the end-use compared to the boiler plant and the distance that the condensate will have to be piped in order to get it to the boiler plant. Additionally, designs will have to consider electrically pumping the condensate back versus using the steam pressure and a lift station.

Condensate receivers can serve as a local collection point and help to reduce the project costs of individually pumping condensate back from each end-user. Additionally, condensate receivers and flash tanks reduce the amount of steam entering the condensate return piping and this mitigates flow restrictions in the return piping. It will also help to eliminate water hammer in condensate return systems.

The amount of condensate to be recovered can be obtained in several different ways, including:

- Steam flow rate
- Steam trap size
- Energy and mass balance on the process end-use heat exchanger
- Design conditions
- Bucket and stopwatch (exercise extreme caution)

### Example

An end-user in a process plant uses steam to heat the feed stream. Condensate is currently dumped into the sewer. A bucket and stopwatch methodology indicated that the condensate flow rate was 50 liters/min. Estimate the energy and cost savings associated with collecting and returning condensate to the boiler plant from this end-user. Current condensate collected elsewhere in the plant returns to the boiler at 70°C.

Incorporating a condensate recovery system would require a condensate receiver with an ambient vent to collect all the condensate. It would then be pumped to the boiler plant as shown in Figure 29. Assume that this condensate return temperature at the boiler would also be 70°C, which is similar to other condensate being returned.

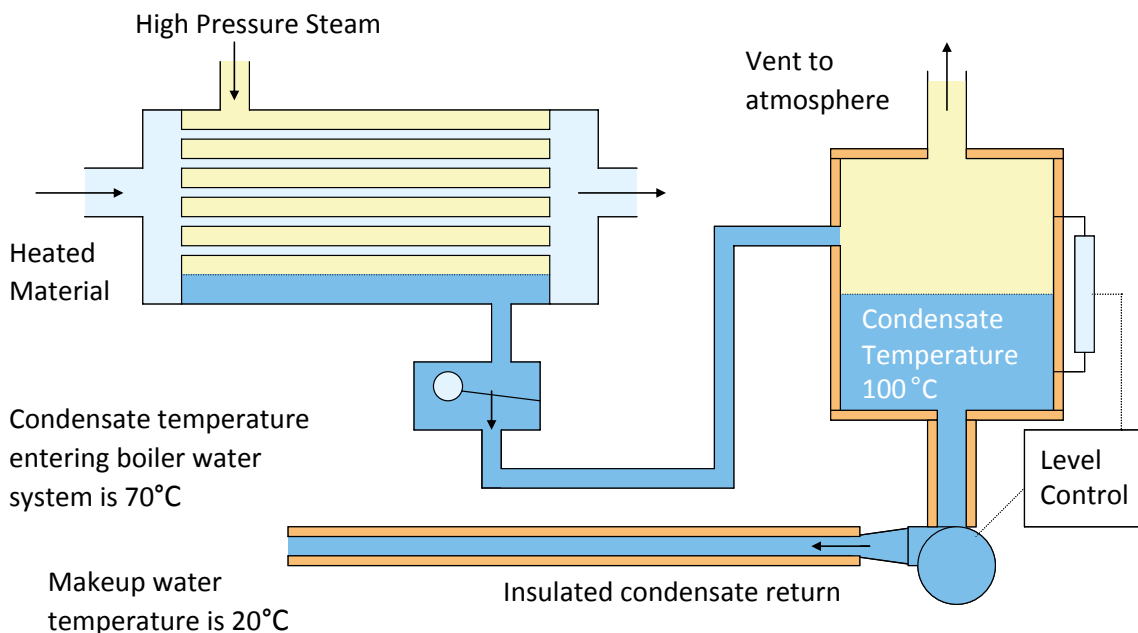


Figure 29: Condensate Return System  
(Courtesy: US DOE BestPractices Steam EndUser Training)



The mass flow of condensate to be returned is calculated as follows:

$$m_{\text{condensate}} = V_{\text{condensate}} \times \rho_{\text{condensate}}$$

where  $V_{\text{condensate}}$  is the volume flow rate and  $\rho_{\text{condensate}}$  is the density of condensate at the saturation temperature.

$$m_{\text{condensate}} = \frac{50}{60} \times \frac{977.8}{1,000} = 0.81 \text{ kg/s}$$

The amount of thermal energy in the condensate compared to equivalent make up water is given by:

$$Q_{\text{condensate}} = m_{\text{condensate}} \times (h_{\text{condensate}} - h_{\text{makeup}})$$

where  $h_{\text{condensate}}$  is the enthalpy of condensate (293.1 Btu/lb) at 70°C and  $h_{\text{makeup}}$  is the enthalpy of makeup water (83.9 Btu/lb) at 20°C. These were obtained from steam tables.

$$Q_{\text{condensate}} = m_{\text{condensate}} \times (h_{\text{condensate}} - h_{\text{makeup}})$$

$$Q_{\text{condensate}} = 0.81 \times (293.1 - 83.9) = 169.5 \text{ kW}$$

In an industrial steam system, the makeup water would be heated by the steam in the deaerator. This implies that the actual fuel energy savings would need to incorporate the boiler inefficiencies. Hence, fuel energy and cost savings for condensate return from a system perspective are calculated as follows:

$$Q_{\text{system}} = \frac{Q_{\text{condensate}}}{\eta_{\text{boiler}}} = \frac{169.5}{0.80} \approx 212 \text{ kW}$$

$$\sigma_{\text{condensate}} = \frac{Q_{\text{system}} \times k_{\text{fuel}} \times T}{\text{HHV}_{\text{fuel}}} = \frac{212 \times 1.0 \times 3,600 \times 8,760}{40,144} \approx \$166,500/\text{yr}$$

Condensate return calculations as done above provide a very accurate measure of the optimization opportunity. Nevertheless, condensate return impacts the whole system and it is generally recommended to use a detailed steam system model to evaluate the true impacts of condensate return. Water costs (including chemical treatment) can account for a large fraction of the cost savings and should not be neglected.

### 8.3.3. Recover Condensate at the Highest Possible Thermal Energy

It is clear from the above discussions that higher condensate return temperatures imply lesser heating required in the deaerator. This directly translates to steam and energy cost savings. This optimization opportunity can be evaluated in a very similar manner as explained and demonstrated above. But collecting and returning high temperature condensate may require significant due-diligence which, if not provided, could result in operational problems. The biggest concern is the issue of flashing that could happen in the condensate return lines. The problem can be magnified in a cascade system, where condensate from different locations is mixed and there are large temperature differences between the condensate returns.

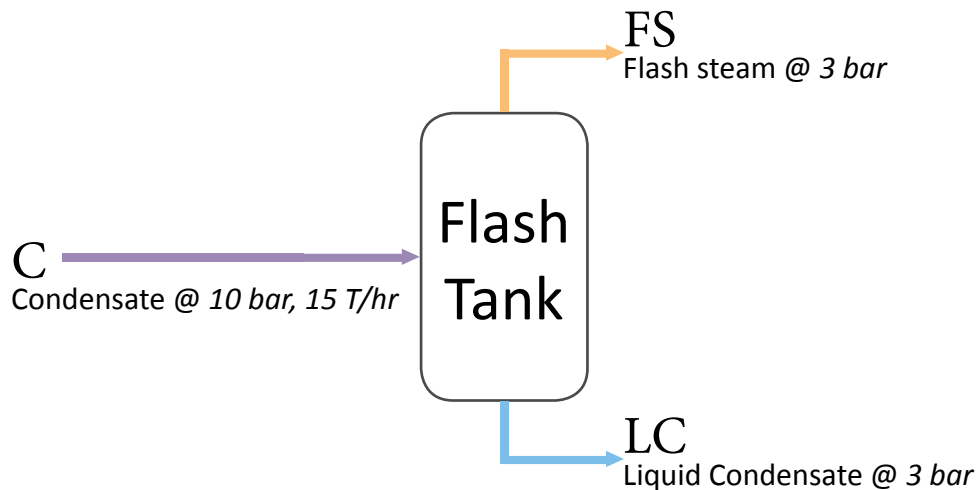
The steam systems optimization strategy weighs the additional cost of dedicated high temperature condensate return compared to having a condensate receiver / flash tank (with an ambient vent) to remove this extra thermal energy. Depending on the amount of condensate, this thermal energy can be significant and every effort should be made to capture condensate and return it back to the boiler plant with the highest thermal energy possible.

### 8.3.4. Flash High Pressure Condensate to make Low Pressure Steam

In industrial plants which have steam usage at different pressure levels, this optimization opportunity can significantly impact operating energy and costs. As mentioned earlier, condensate contains a lot of thermal energy and if it is at a higher pressure it can be collected and flashed to produce low pressure steam. Depending on the location and proximity to the headers or end-uses, this low pressure steam directly offsets “live” steam on the low pressure header that was produced by the boiler.

**Example:**

Medium pressure condensate at 10 bar saturated conditions is taken into a flash tank operating at 3 bar. Based on a mass balance at the end-users, this condensate flow is estimated to be 15 Tph. Assuming a steady state steady flow operation, calculate the amount of flash steam produced in the 3 bar flash tank.



The amount of flash steam produced is a function of the enthalpies of the saturated conditions at the two pressure levels.

$$\text{Fraction of flash steam produced} = (h_{\text{condensate}_{10}} - h_{\text{condensate}_{3}}) / (h_{\text{steam}_{3}} - h_{\text{condensate}_{3}})$$

The enthalpy values obtained from the steam tables are as follows:

- Condensate (10 bar; saturated conditions): 781.5 kJ/kg
- Condensate (3 bar; saturated conditions): 605.3 kJ/kg
- Steam (3 bar; saturated conditions): 2,738.6 kJ/kg



Substituting the values of enthalpy from above, we get

$$\text{Fraction of flash steam produced} = (781.5 - 605.3) / (2738.6 - 605.3) = 8.26\%$$

$$\text{Amount of flash steam produced} = 0.0826 * 15 = 1.24 \text{ Tph}$$

To evaluate the true economic impacts of this optimization opportunity in the total steam system, the US DOE SSAT tool would be very useful. Figure 30 provides a simple snap-shot of an industrial steam system balance in the SSAT tool to illustrate the impacts of flashing high pressure condensate to produce lower pressure steam.

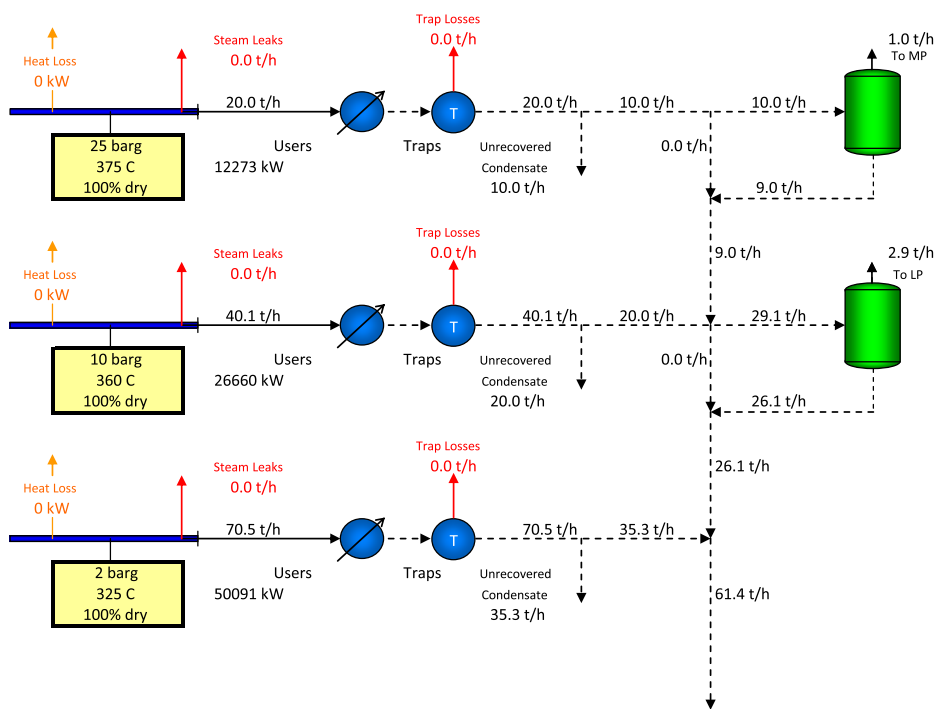
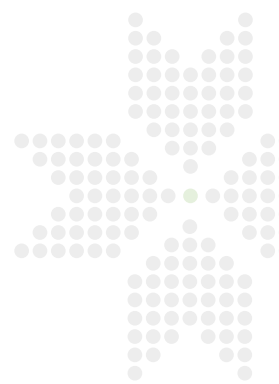


Figure 30: Flashing High Pressure Condensate to make Low Pressure Steam



## 9. COMBINED HEAT & POWER (CHP) OPTIMIZATION OPPORTUNITIES

---

Steam is produced in an industrial plant primarily for providing heat to the processes. Nevertheless, steam can also be used to generate power or drive any rotating mechanical equipment such as a pump, compressor, fan, etc. Typically, this power is generated via steam turbines. Steam turbines do not consume steam and are not therefore treated as end-users of steam. This section details the different types of steam turbines that can be found in industrial plants and the optimization opportunities related to Combined Heat and Power (CHP), which is also known as Cogeneration.

### 9.1. Overview

An industrial plant operation needs both power and thermal energy (in the form of heat) simultaneously. Typically, the industrial plant has a power supply agreement with a utility company (and a generator) to supply a certain amount of electricity to the plant. There are different types of power agreements but in general an industrial plant pays a certain cost for the amount of power it purchases from the electric utility grid. Power supplied to the grid from central power stations which are based on typical Rankine-cycle are  $\sim 35\text{-}42\%$  thermal efficiency. This implies that there is a large amount of thermal energy lost to the ambient (via cooling towers, river water, etc.) at the power generation site.

The industrial plant also buys fuel from a utility company to operate boilers or other direct-firing process heating equipment to supply its thermal demand. Alternately, an industrial plant with a steam system can operate a topping cycle, which can produce power via a steam turbine and then use the exhaust steam to satisfy the thermal demand of the processes. The overall thermal efficiency for such an industrial plant combined heat and power system can be  $70\%$  or higher. This is the main reason for implementing CHP optimization opportunities in industrial systems. There can be a significant amount of energy and cost savings including a highly reliable power supply configuration with CHP in industrial plants. Nevertheless, there could be a large capital cost as well as potentially some operating costs associated with the CHP optimization opportunity.



CHP will almost always be energy efficient compared to central utility plant power generation. But the CHP cost effectiveness and economics of operations are not always beneficial to the industrial plant. Each industrial plant CHP analysis is unique and should be done independent of thumb rules. The overall economics of CHP operation depends on the following factors:

- Impact or marginal electric utility cost
- Impact or marginal fuel cost
- Boiler efficiency
- Steam turbine efficiency
- Thermal demand
- Timing of thermal and electric demand

The main questions that are typically required to be answered while optimizing the operations of any CHP system are:

- What is the true economic impact of cogeneration?
- When is it viable?
  - To operate or shut down
  - To install
- What changes, if any, will be required in the steam system?
- What changes, if any, will be required in the electrical utility system and grid interconnects?

## 9.2. Steam Turbines

A thorough understanding of steam turbine operations will be required when optimizing boiler-steam turbine CHP systems. Steam turbines are devices which convert thermal energy from the steam into rotational shaft power. Steam turbines operate with high-pressure steam passing through a nozzle that increases the velocity of the steam and focuses the flow path into a jet of steam. This high-velocity jet of steam is directed to strike a blade. The blade is arranged such that the steam jet will transfer its energy into a force on the blade. The blade is mounted on a shaft that is free to rotate. As a result, the force on the blade is converted into shaft torque and shaft rotation. Steam turbines are equipped with a stationary outer shell and a rotating inner shaft. The outer shell confines the steam and serves as the anchor for the nozzles and all of the stationary parts. The rotating shaft is equipped with the turbine blades and serves to collect and transfer the mechanical power from the turbine.

A steam turbine can be designed with a single wheel of blades or multiple wheels on the same shaft. A single nozzle directs steam to a wheel or several nozzles can direct steam to segments of a single wheel. If a turbine has multiple rows of blades it will also be equipped with multiple rows of nozzles. The nozzles serve to collect the steam from the upstream blades, increase the velocity of the steam, channel the steam into a focused jet, and direct the steam to the blades.

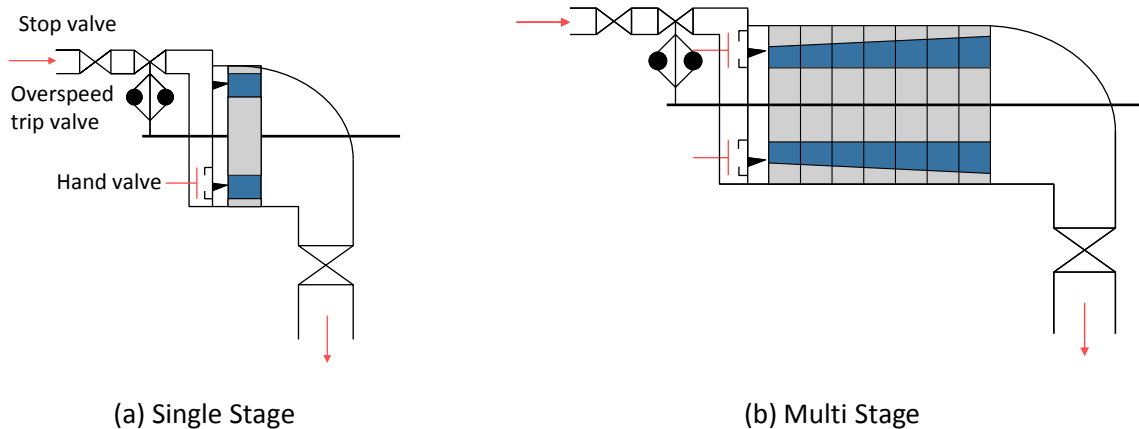
All steam turbines receive high-pressure steam and discharge low-pressure steam. Based on their operations and steam flow configurations, steam turbines are classified as follows:

- Backpressure
- Extraction
- Condensing
- A combination of the above



### 9.2.1. Backpressure Turbine

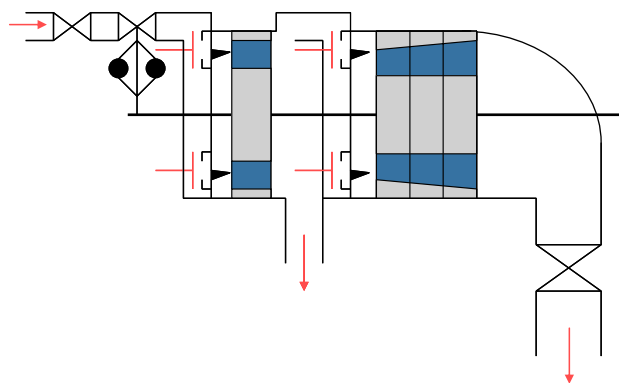
A backpressure turbine exhausts steam to a steam header with a pressure that is above atmospheric pressure. Backpressure turbines are also known as topping turbines and non-condensing turbines. Backpressure turbines are the most common turbines in industrial plants. Backpressure turbines are always used in lieu of pressure reducing stations and are always located in parallel with pressure reducing stations between two steam headers. Backpressure turbines can be single stage (Figure 31a) or multi-stage (Figure 31b). Generally, multistage turbines are more efficient than single stage turbines.



**Figure 31: BackPressure Steam Turbines**  
(Courtesy: US DOE Steam BestPractices End User Training)

### 9.2.2. Extraction Turbine

A backpressure extraction turbine is a backpressure turbine with one or more additional ports for extracting steam at intermediate pressures between the inlet and the exhaust of steam. Backpressure extraction turbines can also be thought of as multiple turbines operating on the same shaft. They are commonly found in industrial plants that have multiple steam pressure headers. They are an excellent candidate for balancing steam headers & eliminating steam venting on intermediate headers. Figure 32 shows a schematic of a backpressure extraction turbine.



**Figure 32: BackPressure Extraction Steam Turbine**  
(Courtesy: US DOE Steam BestPractices End User Training)



### 9.2.3. Condensing Turbine

A condensing turbine does not exhaust steam into a steam header but instead exhausts steam below atmospheric pressure to a surface condenser. The thermodynamic quality of the steam exiting a condensing steam turbine is typically greater than 90%. It contains a significant amount of thermal energy as it enters the surface condenser. The condenser uses cooling tower water (or river water) in the tubes to condense the steam on the shell side. Saturated water (condensate) is then removed from the condenser and pumped back to the boiler plant. Condensing turbines are large units and mainly used to generate power or drive large mechanical equipment such as centrifugal chillers, air compressors, etc. Figure 33 schematically represents a condensing turbine.

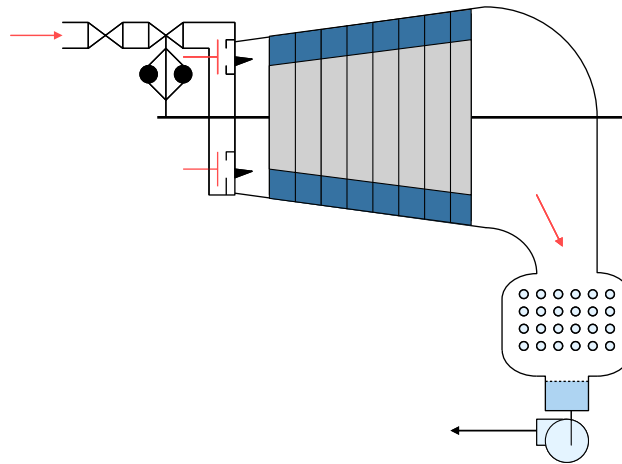


Figure 33: Condensing Turbine  
(Courtesy: US DOE Steam BestPractices End User Training)

An extraction-condensing turbine is a combination of an extraction and a condensing turbine. It is very commonly used to balance steam and power demands simultaneously.

### 9.3. Steam Turbine Efficiency

Steam turbine efficiency is not the same as boiler efficiency which follows the first law of thermodynamics. Steam turbine efficiency relates to the second law of thermodynamics and is a comparison of the actual turbine operation with that of a perfect turbine operating with the same inlet conditions and outlet pressure. Hence, it is also called isentropic turbine efficiency.

Isentropic turbine efficiency is a comparison of the shaft power from an actual turbine operation to that of a perfect (ideal) turbine operating with the same inlet conditions and outlet pressure (not outlet temperature!). Mathematically, it is expressed as follows:

$$\eta_{turbine} = \frac{\text{Shaft Power of Actual Turbine}}{\text{Shaft Power of Ideal Turbine}}$$
$$\eta_{turbine} = \frac{m_{steam} (h_{inlet} - h_{exit})_{actual}}{m_{steam} (h_{inlet} - h_{exit})_{ideal}} = \frac{(h_{inlet} - h_{exit})_{actual}}{(h_{inlet} - h_{exit})_{ideal}}$$

**Example**

Calculate the isentropic efficiency and shaft power produced by a backpressure steam turbine operating with steam inlet conditions of 25 bars and 375°C. The exhaust conditions are 2 bars and 271°C. The throttle steam flow of the turbine is 21 Tph.

The thermodynamic properties of steam are obtained from the steam tables for the temperature and pressure conditions. They are as follows:

Actual Turbine:

- $H_{inlet} = 3,180.9 \text{ kJ/kg}$  (based on 25 bars and 375°C)
- $H_{exit} = 3,009.8 \text{ kJ/kg}$  (based on 2 bars and 271°C)

Ideal Turbine:

- $H_{inlet} = 3,180.9 \text{ kJ/kg}$  (based on 25 bars and 375°C)
- $H_{exit} = 2,692 \text{ kJ/kg}$  (based on 2 bars and entropy same as the inlet conditions)

Substituting the above information in the equation on steam turbine efficiency provides:

$$\eta_{turbine} = \frac{(h_{inlet} - h_{exit})_{actual}}{(h_{inlet} - h_{exit})_{ideal}}$$

$$\eta_{turbine} = \frac{(3,180.9 - 3,009.8)}{(3,180.9 - 2,692)} = 0.35$$

The isentropic turbine efficiency is calculated as 35%. The shaft power from this actual turbine is calculated as follows:

$$W_{actual} = m_{steam} (h_{inlet} - h_{exit})_{actual}$$

$$W_{actual} = \frac{21,000}{3,600} \times (3,180.9 - 3,009.8) = 1,000 \text{ kW}$$

The ideal turbine shaft power can also be calculated from the above equations. The ideal turbine shaft power will be the maximum work that is theoretically possible given the steam inlet conditions and the exit pressure.

$$W_{ideal} = m_{steam} (h_{inlet} - h_{exit})_{ideal}$$

$$W_{ideal} = \frac{21,000}{3,600} \times (3,180.9 - 2,692) = 2,850 \text{ kW}$$

A steam turbine can have an efficiency ranging from 15-85%. A steam turbine with a low isentropic efficiency merely indicates that its ability to convert thermal energy into shaft power is weak. Hence, it preserves most of the thermal energy in the steam as it exhausts from the backpressure turbine and is used to supply the thermal demand of the industrial processes. This energy is not lost as would have been the case if this was the first law efficiency, as is the case with boiler efficiency.

The exception to the above discussion is the condensing turbine, which may reject all of its exhausted thermal energy to the ambient via the cooling water in the surface condenser.



## 9.4. Steam Rate

Steam rate is an expression used to describe the amount of steam required to produce a specific amount of power. It is widely used in industry to specify the performance of an actual turbine. It can be related to turbine efficiency for given inlet conditions and exhaust pressures. Nevertheless, the steam rate is extremely dependent upon the inlet and outlet conditions. Throttling the inlet of the turbine may not change the turbine's isentropic efficiency but it can change the steam rate significantly. Caution should therefore be exercised when working with steam rates and comparing turbine performances using steam rates. Figure 34 shows a typical graph for correlating steam rates and turbine efficiency.

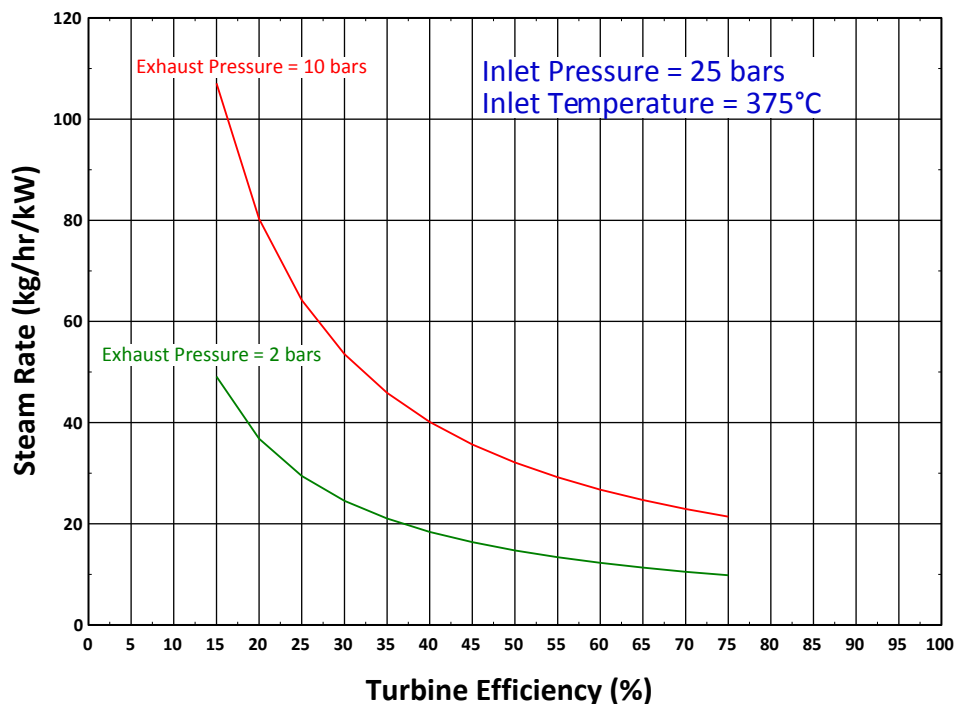


Figure 34: Steam Rate and Steam Turbine Efficiency

## 9.5. CHP Optimization Opportunities & Best Practices

The CHP optimization opportunity in industrial steam systems almost always relies upon an understanding of the economic benefit of modifying the operations of steam turbines. In industrial CHP applications, two major turbine configurations are encountered. They include:

- Backpressure
- Condensing

### 9.5.1. CHP Optimization Opportunity with Backpressure Turbine

This opportunity specifically exists in industrial plants which have more than one steam pressure level where steam is required by the end-use processes. Additionally, having a continuous flow of steam through pressure reducing valves indicates that the plant may be a very good candidate to evaluate for a CHP optimization opportunity using a backpressure

turbine. Evaluation of this optimization opportunity would require use of detailed steam system thermodynamic models. The evaluation methodology is best explained using an industrial plant example given below.

**Example**

A methane gas boiler with an efficiency of 80% produces superheated steam at 25 bars and 375°C. The thermal demand for a process end-use is 14,300 kW and requires steam at 2 bars. Currently, this steam flows through a Pressure Reducing Valve (PRV). Saturated condensate is discharged from the process load at 2 bars. Estimate the economic benefit of a CHP optimization opportunity by implementing a backpressure steam turbine that directly drives a pump requiring 1,000 kW of electric power. The steam isentropic turbine efficiency is expected to be 35%. The impact fuel cost is \$1/Nm<sup>3</sup> and the impact electric utility cost is \$0.10/kWh.

Figure 35 depicts the current operation at the industrial plant. Based on the thermal end-use demand, steam flow through the PRV (Pressure Reducing Valve) can be calculated as follows:

$$Q_{enduse} = m_{PRV} (h_{PRV} - h_{condensate})$$

$$m_{PRV} = \frac{Q_{enduse}}{(h_{PRV} - h_{condensate})} = \frac{14,300}{(3,180.9 - 562.2)} = 5.45 \text{ kg/s} = 19.63 \text{ Tph}$$

where  $Q_{enduse}$  is the thermal demand;  $h_{PRV}$  is the enthalpy of steam exiting the PRV and entering the end-use and  $h_{condensate}$  is the enthalpy of condensate leaving the end-use.

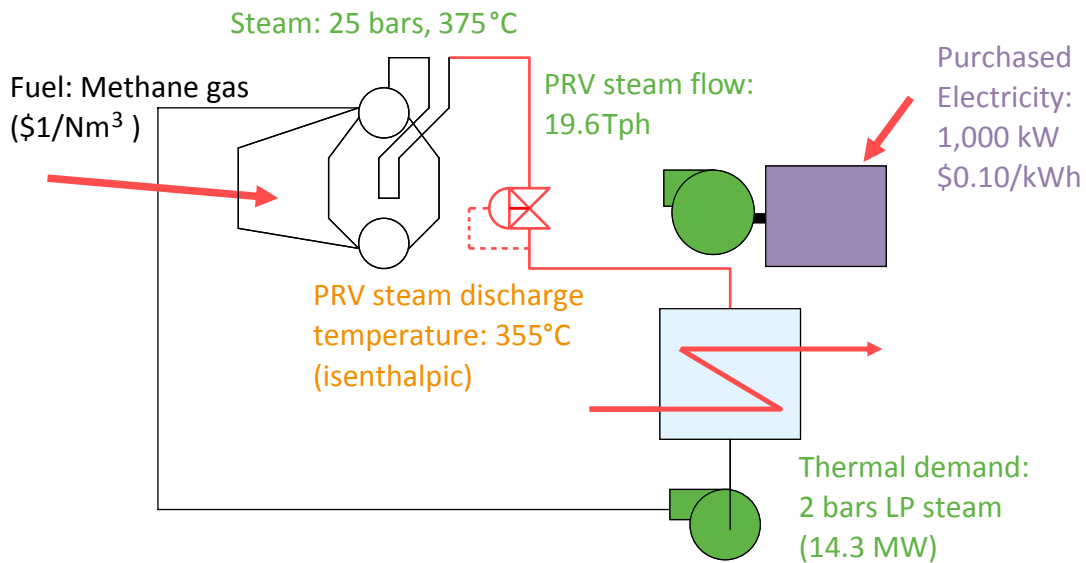


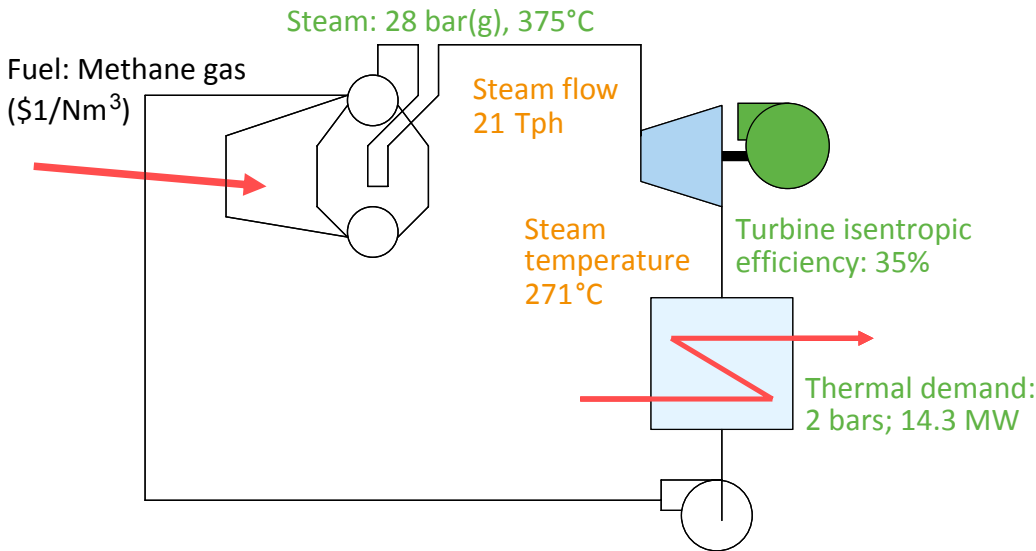
Figure 35: Current Operation at Industrial Plant using PRV

The CHP optimization opportunity will implement a backpressure steam turbine that will reduce the steam pressure from 25 bars to 2 bars. While doing so it will do shaft work which will drive the pump and offset the 1,000 kW of electric purchase from the grid. The steam turbine will extract energy from the steam and convert it into shaft energy thereby reducing the steam enthalpy exiting the turbine. This implies the steam will exit the turbine with a reduced temperature compared to the PRV. To satisfy the same thermal demand as in the current operation, there will be a net increase in the mass flow rate of steam.



This additional steam will have to be produced by the boiler and the fuel energy cost for operations will increase. Figure 36 represents the new configuration of the industrial application with the steam turbine and CHP.

Figure 36: CHP Configuration at Industrial Plant using Steam Turbine



Comparing Figures 35 and 36 indicates that the steam entering the end-use has dropped in temperature from 355°C to 271°C. Based on the thermal end-use demand, steam flow through the steam turbine can be calculated as follows:

$$Q_{enduse} = m_{turbine} (h_{turbine} - h_{condensate})$$

$$m_{turbine} = \frac{Q_{enduse}}{(h_{turbine} - h_{condensate})} = \frac{14,300}{(3,009.8 - 562.2)} = 5.83 \text{ kg/s} = 21.0 \text{ Tph}$$

where  $Q_{enduse}$  is the thermal demand;  $h_{turbine}$  is the enthalpy of steam exiting the steam turbine and entering the end-use and  $h_{condensate}$  is the enthalpy of condensate leaving the end-use.

The electrical energy cost savings associated with this CHP optimization opportunity are given by:

$$\sigma_{electric} = kW \times T \times k_{electric}$$

$$\sigma_{electric} = 1,000 \times 8,760 \times 0.10 = \$876,000/yr$$

The fuel energy cost increases associated with this CHP optimization opportunity are given by:

$$\sigma_{fuel} = (m_{turbine} - m_{PRV}) \times \frac{(h_{steam} - h_{feedwater})}{\eta_{boiler} \times HHV_{fuel}} \times k_{fuel} \times T$$

$$\sigma_{fuel} = (21.0 - 19.63) \times 1,000 \times \frac{(3,180.9 - 463.5)}{0.80 \times 40,144} \times 1.0 \times 8,760$$

$$\sigma_{fuel} = \$1,038,000/yr$$

Hence, the net economic benefit of this CHP optimization opportunity is given as follows:

$$\sigma_{CHP} = \sigma_{electric} - \sigma_{fuel}$$

$$\sigma_{CHP} = 876,000 - 1,038,000 = - \$162,000/yr$$

This example clearly shows that the CHP optimization opportunity is not a viable solution strategy in this industrial plant application.

Using the key parameters that influence the economic benefit of the CHP optimization opportunity, a parametric analysis was done. The results from this parametric analysis are provided in Table 6 below and clearly indicate when the CHP optimization opportunity can be economically justified in this industrial plant application.

**Table 6: Parametric Analysis for a BackPressure Steam Turbine CHP Optimization Opportunity**

Power Cost	Fuel Cost	Turbine Efficiency	SSAT Boiler Efficiency	Additional Power	Additional Steam	Cost Savings
(\$/kWh)	(\$/GJ)	(%)	(%)	(kW)	(Tph)	(\$K/yr)
0.100	25.0	35.0	81.7	998	1.5	(221)
0.125	25.0	35.0	81.7	998	1.5	(2)
0.100	12.5	35.0	81.7	998	1.5	325
0.100	5.4	35.0	86.7	998	1.5	650
0.100	25.0	65.0	81.7	1,853	2.8	(409)

Table 6 was developed using a US DOE SSAT model while doing a steam turbine implementation project. The impact power cost, impact fuel cost, steam turbine efficiency and impact boiler efficiency were varied individually to obtain the results presented in the Table. A detailed due diligence and parametric analysis will be required for each CHP optimization opportunity to demonstrate and answer all questions related to the economic viability of the CHP optimization opportunity.

### 9.5.2. CHP Optimization Opportunity with Condensing Turbine

From the perspective of the definition of CHP in the strictest sense, condensing turbine operations do not necessarily fall under CHP optimization opportunities. Nevertheless, they will still be covered here because the analysis principles are identical to those that have been discussed in the backpressure steam turbine cases. The main difference is that the steam passing through the condensing turbine does not exhaust to a steam header and neither does it satisfy any thermal demand. It is actually condensed in the surface condenser at the exit of the turbine. It therefore loses all its thermal energy to the cooling water flowing in the tubes of the surface condenser. The condensing turbine aims to maximize power production from the steam to minimize thermal energy losses to the ambient.



The primary factors that influence condensing turbine operations are:

- Impact power cost
- Impact fuel cost
- Turbine efficiency
- Boiler efficiency
- Turbine discharge pressure

The power generated by the turbine is a function of the pressure ratio between the inlet and exhaust pressures. Typically, the inlet pressure is the steam generation pressure or a low pressure header in the steam system. But the exhaust pressure plays a very significant role in the amount of power produced. The exhaust pressure of the turbine is controlled by the surface condenser and this pressure should be maintained as close to design conditions as possible. There are several areas that should be targeted to ensure that the condenser pressure is at design conditions including:

- Removing non-condensable gases from condenser
- Cleaning the condenser periodically
- Supplying the condenser with reduced temperature water
- Supplying the condenser with additional cooling water

Evaluation of a condensing turbine related CHP optimization opportunity will require a detailed thermodynamic steam system model such as the US DOE SSAT tool. Table 7 presents a parametric analysis done on a condensing turbine industrial application that uses 25 bars, 375°C inlet steam and exhausts at 0.1 bar (absolute) pressure. The boiler efficiency is maintained at 80% and the fuel cost and turbine efficiency is varied.

**Table 7: Parametric Analysis for a Condensing Turbine CHP Optimization Opportunity**

Condensing Turbine Impact Power Cost			
Fuel Cost [\$/GJ]	Impact Condensing Power Cost [\$/MWh]		
	Turbine Isentropic Efficiency [%]		
	40	60	80
2.0	56	39	30
4.0	111	78	60
6.0	167	116	89
8.0	223	155	119
10.0	278	194	149
12.0	334	233	179
<b>Steam inlet</b>	<b>25</b>	<b>bars</b>	
<b>Steam inlet</b>	<b>375</b>	<b>°C</b>	
<b>Steam exit</b>	<b>0.1</b>	<b>bar(a)</b>	



Table 7 provides the condensing turbine power generation costs based on different isentropic turbine efficiencies and impact fuel costs. As can be observed, for an industrial plant that purchases electric utility power at \$100 per MWh, it will only be cost effective to run the condensing turbine if impact fuel costs are \$2.0 per GJ or lower, irrespective of turbine efficiencies considered in the analysis. But as the impact fuel price increases to \$4.0 per GJ, turbine efficiencies will need to be 60% or higher to be economically beneficial. Further increase in the impact fuel cost to \$6.0 per GJ will require turbine operating efficiency of 80% or higher. When costs go to \$8.0 per GJ and above, condensing turbine CHP operations will not be economical at all if electric power can be purchased from the grid at \$100 per MWh.

It should be noted that as condensing turbine CHP optimization opportunities are implemented, they result in major steam flow changes. Turning a condensing turbine ON can require another boiler to be turned ON and turning a condensing turbine OFF may lead to shutting down a boiler. These changes can change the impact boiler and the impact fuel cost. Care has to be taken to ensure that all the economic analysis properly accounts for these large changes in steam flows.



## 10. STEAM SYSTEM ASSESSMENT PROTOCOL

---

It is important for a system-specific energy assessment to follow a protocol that sets the expectations of the industry and deliverables from the energy auditors. The energy industry has matured significantly over the years but along with that it has introduced several different definitions, expectations, requirements and deliverables. Until 2009, there was no system-specific energy assessment standard and there was no specific protocol(s) to conduct system-specific energy assessments. Then in 2009, significant collaborative efforts led by the US Department of Energy, industry subject matter experts and the American Society of Mechanical Engineers (ASME) created four new system specific energy assessment standards. They are:

- Energy Assessment for Process Heating Systems (ASME EA-1-2009)
- Energy Assessment for Pumping Systems (ASME EA-2-2009)
- Energy Assessment for Steam Systems (ASME EA-3-2009)
- Energy Assessment for Compressed Air Systems (ASME EA-4-2010)

These standards were approved as national standards by the American National Standards Institute (ANSI) and are now publically available.

This section of the Experts Training Manual relies heavily on the standard - Energy Assessment for Steam Systems (ASME EA-3-2009). It is expected that steam system energy experts and consultants will have a copy of the standard. This chapter is provided here within the Experts Training Manual to provide an overview of the assessment protocol and highlight some of the salient features.

### 10.1. Industrial Energy Assessments

As mentioned before, there are several different kinds of industrial energy assessments. Their definitions, titles, purposes and scopes vary significantly. Additionally, these assessments vary based on the assessor or auditor doing the assessment. Nevertheless, most often they are distinguished by the purpose and scope that these assessments are intended to serve.

One way to distinguish industrial energy assessments is strictly based on the focus or the scope of the assessment. This is also the most common configuration for distinguishing industrial energy assessments. The three main types of industrial assessments by scope are:

- Plant-wide
- System-specific
- Process-focused

The overall plant-wide energy assessments are cross-cutting and are typically done at a very high level to provide some very rough estimates for total potential energy savings possibilities at the plant site. These overall plant-wide assessments are also used to generate ideas for the next steps towards detailed energy assessments and getting management buy-in to undertake them at the plants. These overall plant-wide assessments are also very prevalent in the small and medium-sized industrial plants because the overall energy consuming systems are not very large and are relatively simple and so can be handled easily in an overall plant-wide energy assessment. These plant-wide energy assessments can be conducted by teams of experts or by an individual. Typically, an assessment is done via a plant walk-through, meetings and interviews of key plant personnel, utility bill information and qualitative scorecards that provide an understanding of maintenance and operating level bestpractices in the plant.

The system-specific assessments are the ones which are specifically targeted to a specific energy consuming system, such as steam, compressed air, pumping, process heating, etc. Throughout this Experts Training Manual, the focus is on these kinds of systems in the specific area of steam. These assessments typically take place over several days and require a significant amount of planning, on-site data collection, modeling of systems, understanding of production and seasonality impacts, etc. These system-specific assessments are detailed enough that they can lead to identification of actual potential energy savings projects and can quantify the economic benefits of implementing those system-specific optimization projects.

The process-focused assessments are typically the outcome of a process/utility energy optimization project that was identified during a system-specific assessment as a good candidate for implementation. Nevertheless, it may be a capital intensive project which will require significant additional due-diligence or it may require a very high process integration. Some classic examples of these process-focused assessments include projects that are based on using waste heat recovery from process to produce power, refrigeration, etc. These process-focused assessments may also be done on specific unit operations that may have multiple systems interacting in major equipment or machines. An example of such a configuration would be a stand-alone paper machine or a distillation column.

The overall goal of all these types of industrial energy assessments is to identify and quantify energy savings opportunities, thereby leading to system optimization, improved energy intensity (reduced specific energy consumption), lower operating costs and reduced greenhouse gas emissions.

## 10.2. Steam System Industrial Energy Assessment Standard

The ASME Standard (ASME EA-3-2009) – Energy Assessment for Steam Systems is a non-prescriptive standard that clearly identifies the processes, protocols and deliverables of a steam assessment. The intent of this section is to highlight some of the key features of the standard



and develop a familiarity on the behalf of the Steam System Expert that will allow him/her to use the standard while planning, undertaking and reporting on the steam system assessment. The different sections of the ASME Standard are:

- Scope & Introduction
- Definitions
- References
- Organizing the Assessment
- Conducting the Assessment
- Assessment Data Analysis
- Report & Documentation
- Appendix A – Key References

In addition to the ASME Standard, there is an accompanying guidance document (ASME EA-3G-2010 – Guidance for ASME EA-3, Energy Assessment for Steam Systems) that further helps the Steam System Expert properly apply the Standard during an energy assessment. The different sections of the ASME Guidance document are:

- Scope
- Definitions
- Overview of the Standard – How to use ASME EA-3
- Guide to Organizing the Assessment
- Guide to Conducting the Assessment
- Guide to Assessment Data Analysis
- Guide to Report & Documentation
- Non-Mandatory Appendix A – Key References

It is expected that the use of this ASME Standard and the accompanying Guidance Document should increase the quantity and quality of energy assessments performed, with significant potential savings in implemented energy costs and steam systems optimization. The Standard and the Guidance Document are intended for energy managers, facility managers, plant engineers, energy consultants, maintenance managers, plant managers and EH&S managers, across a broad range of industries.

### 10.3. Typical Project Areas in a Steam System Energy Assessment

Every industrial plant is different and unique. Additionally, each steam system in an industrial plant will be different and will vary even for plants manufacturing the same product and belonging to the same company. It is therefore very difficult to compile a list of specific opportunities in steam systems that can be guaranteed to exist at each plant. Every facility or industrial plant will have to be individually assessed and the steam systems optimization opportunities quantified specifically for that plant. Nevertheless, every industrial steam system plant should be evaluated for the following steam systems optimization opportunities during the industrial steam systems assessment:

- Boiler efficiency improvement
- Fuel switching
- Boiler blowdown thermal energy recovery
- Steam demand reduction
- General turbine operations
- Thermal integration
- Process/Utility integration
- Turbine-PRV operations
- Condensing turbine operations
- Thermal insulation
- Condensate recovery
- Flash steam recovery
- Steam leaks management
- Steam trap management
- Waste heat recovery

## 10.4. Energy Savings Opportunities

One of the major goals of the steam system energy assessment is to help the industry identify, quantify and implement steam system optimization projects once the steam system assessment is completed. But this always leads to the classic question of: What is the return on investment (payback) for implementing the steam system opportunities for the industry?

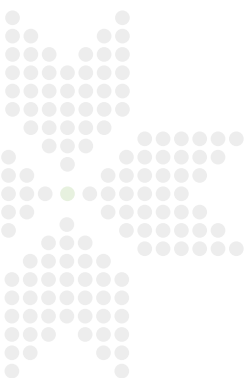
It is expected that one of the deliverables of the steam system assessment is to group the energy savings opportunities into three groups based on their return on investment and capital expense. The three categories are:

- Near-term
- Mid-term
- Long-term

There is no specific protocol to define which projects fall into which category and it will also heavily depend on several factors at the industrial plant. Nevertheless, Table 8 below provides general guidance to the Steam System Energy Expert on how to place each of the energy savings opportunities within the three categories.

**Table 8: Categories of Energy Savings Opportunities**

	Near-term	Mid-term	Long-term
Definition	Improvements in operating and maintenance practices	Require purchase of additional equipment and/or system changes	New technology or confirmation of performance
Capital Expense	Low cost actions or equipment purchases	Rules of thumb estimates can be made	Additional due-diligence required
Payback	Less than one year	One to two year	Two to five-year
Examples of Projects	<ul style="list-style-type: none"> <li>• Boiler combustion tuning</li> <li>• Insulation</li> <li>• Steam leaks</li> <li>• Steam trap management</li> </ul>	<ul style="list-style-type: none"> <li>• Automatic combustion control</li> <li>• Blowdown energy recovery</li> <li>• Feedwater economizer</li> </ul>	<ul style="list-style-type: none"> <li>• Combined Heat &amp; Power</li> <li>• Steam turbine driven process components</li> <li>• Boiler fuel switching</li> </ul>



# 11. PORTABLE INSTRUMENTS FOR AN INDUSTRIAL STEAM SYSTEM ASSESSMENT

---

## 11.1. Data Collection for Industrial Steam System Assessments

The industrial steam system energy assessment will require a significant amount of data collection. Data can be in several different formats and will depend on the specific industrial plant, steam system being evaluated, scope of the assessment and the actual steam systems optimization projects being evaluated for the industrial steam system. In general, the data collection strategy focuses on two areas of data collection:

- Design information
- Operating data

### 11.1.1. Design Information

Design information is typically used to understand the steam system's capabilities, minimum and maximum operating constraints and limits, energy efficiency parameters, etc. Most often this is gathered from:

- Engineering documents at the plant (if available)
- Manufacturer's published information
- Equipment / System nameplate information
- A combination of the above methodologies

Design information is also used to compare the current operating conditions and the efficiencies with design. But for the most part, steam systems are operated at off-design conditions and a comparison is not always applicable. Nevertheless, it is an excellent data point which should be identified during an industrial steam system assessment.

### 11.1.2. Operating Data

Actual operating data from an industrial steam system is extremely important and has to be collected through calibrated instrumentation with the highest fidelity levels possible. Actual operating data can be collected in several different configurations, including but not limited to:

- Utility-based metered information
- Plant in-situ local indicators
- Plant in-situ instruments w/Data Acquisition System
- Plant historian based information
- Portable instrumentation (snap-shot based)

Operating data frequency is another variable that needs to be properly selected when collecting data during a steam system assessment. Production and steam system loads are not constant (fixed over time) and vary according to type of process, seasonality, schedules, etc. Hence, it is very important to understand the load profile of the industrial processes that use steam before defining the time period of data collection as well as the frequency (time-step) of data collection. For example, steam flow to a batch process can be extremely variable and so operating data collection time steps should be much smaller than the time period of the batch process.

It is typically very difficult to collect data from plant in-situ indicators and/or portable instrumentation over a long period of time unless data loggers and other recording devices are used along with the instrumentation. Nevertheless, in-situ instrumentation with transmitters and historians provide an excellent opportunity to capture operating data in the most convenient format. Additionally, data acquisition systems and historians allow for past data capture and provide average, instantaneous values of process variables over any required frequency / time-step (per second, minute, hour, day) and over any required time period (hour, day, month, year).

In industrial steam systems, operating data measurements of process and utility variables typically consist of:

- Temperature
- Pressure
- Flow
- Combustion analysis
- Energy usage
- Water chemistry
- Power production

Additional information on these measurements is also provided in the ASME Standard EA-3G Guidance Document for the Energy Assessment Standard. It will not be repeated here and the steam system expert is requested to refer to it for more information. This section focuses on the portable instrumentation that should be carried by the steam system energy expert for undertaking a detailed steam system energy assessment as per the ASME Standard EA-3-2009: Energy Assessment Standard for Steam systems.

## 11.2. Portable Instrumentation

The main purpose of having portable instrumentation available for an industrial steam system assessment is to have the ability to take operating data instantaneously and be able to use the information for steam systems optimization opportunities. Most industrial plants' utility systems, such as steam, do not have enough instrumentation to undertake a detailed mass and energy balance on the system. This makes it very difficult to analyze industrial steam systems and understand operating conditions and identify steam systems optimization opportunities. This leads to several assessments where rule of thumb for energy savings estimates are used. Such a steam system assessment loses its credibility in the event that projects are undertaken based on the steam system assessment report and energy and cost savings are not realized in the operations of the industrial plant.





Sometimes portable instrumentation provides an excellent check on the in-situ instrumentation. It does not serve as a full 10-point calibration test but if readings observed by the portable instrumentation match very closely with the in-situ instrumentation, then in general terms it can be said that the in-situ industrial plant instrumentation would be providing good operating data. It should be noted that one-point congruence is not, ideally, enough to ascertain the validity of the in-situ instrumentation and data. Typically, multiple points at different operating conditions should be used to gain additional confidence in the validity of the in-situ instrumentation and readings.

Information about portable instrumentation is divided into categories based on what the instruments are measuring. There may be multiple instruments required for measuring a certain process or utility variable. It is intended that the steam system energy expert should have access to this equipment (portable instrumentation) when undertaking a steam system energy assessment in an industrial plant. It should also be noted that the intention of this section is not to promote any particular manufacturer of equipment. Most important is the functionality of the instruments and the technical specifications of the instruments to provide the necessary field operating data.

### 11.2.1. Temperature Measurement

Temperature measurement is one of the most common measurements for steam system analysis. It can be done in several different ways and depending on the application and location of the measurement it will require different types of temperature measurement equipment. The temperature measurement portable instrumentation equipment required for an industrial steam system assessment is:

- Thermal imaging camera
- Hand-held digital thermometer
- Infra-red temperature gun (or thermometer)
- Immersion temperature probe

#### 11.2.1.1. *Thermal Imaging Camera*

An industrial thermal imaging camera is an extremely powerful tool to have in a steam system energy assessment and its functionality varies significantly all throughout the measurement. Its main purpose is to provide a thermal image of the area under consideration. Hence, it always provides the surface temperature of the object under consideration – pipe, vessel, heat exchanger, steam trap, etc. Thermal imaging cameras have different temperature ranges and depending on the options and functionalities available in the camera, the price range can vary significantly. From a steam system energy assessment perspective, certain minimum requirements for these thermal imaging cameras are provided below:

- Temperature range of up to 500°C
- Ability to change emissivity
- IR Detector Resolution (Pixels) 160 x 120 (19,200)
- File Formats – jpeg
- Visual Light Resolution (Pixels) 3 MP
- Allows for picture-in-picture between IR and digital configurations
- Display - 3.5 Inches (320 x 240)
- Has a light to provide for better picture taking in dark areas
- LCD touch screen
- Temperature accuracy +/-2%

Figure 37 provides a few snapshots of a thermal imaging camera in use during an industrial steam system assessment. Figure 38 provides some thermal images of uninsulated components as photographed by the thermal imaging camera.





Figure 37: Using Thermal Imaging Camera in a Steam System Assessment

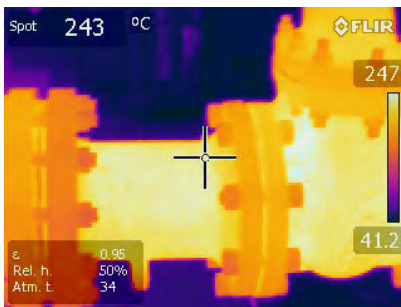


Figure 38: Thermal Images captured during a Steam System Assessment

#### 11.2.1.2. *Infrared Temperature Gun*

An infrared temperature gun (or thermometer) is a much cheaper alternative to the industrial thermal imaging camera. Nevertheless, it is also a very handy tool in collecting surface temperature information regarding the object under consideration – pipe, vessel, heat exchanger, steam trap, etc. Infrared temperature guns have different temperature ranges and depending on the options and functionalities available in the camera, the price range can vary. From a steam system energy assessment perspective, certain minimum requirements for these infrared temperature guns are provided below:

- Temperature range of up to 500°C
- Ability to change emissivity
- Temperature accuracy +/-1%
- Laser Sighting – 1 dot, ring

#### 11.2.1.3. *Handheld Digital Thermometer*

There are several instances during an assessment in which it is not possible to get a good surface or process temperature due to insulation, etc. Under those circumstances it is best to use a handheld thermometer with a thermocouple that can be slid under the insulation. Additionally, if it is a flowing stream (air, water, etc.) or ambient temperature measurement then either a simple thermocouple or probe can be used with this hand-held thermometer. In the event of existing in-situ thermocouples, a handheld thermometer can provide local readings while going through a plant. There are several different kinds of handheld digital thermometers. Some preferred characteristics for these units include:

- Ability to show minimum (MIN), maximum (MAX) and average (AVG) along with the instantaneous for the time duration of the reading
- Has one thermocouple made up and ready for use
- Measures J, K, T, and E-types of thermocouples



#### 11.2.1.4. Immersion Temperature Probe

This is the sheathed stainless steel immersion temperature probe that can be used with the digital handheld thermometer. It can be used to measure temperatures in open systems as well to introduce in existing in-situ thermowells. Typically, a type-K thermocouple would be a good preference for this immersion temperature probe due to the wide range in temperature that it can offer. The probe length should be at least *12 inches* and preferably *18 inches* or more. There are additional options including a good grip to ensure that the person taking the measurement can hold it firmly and not feel the heat.

### 11.2.2. Pressure Measurement

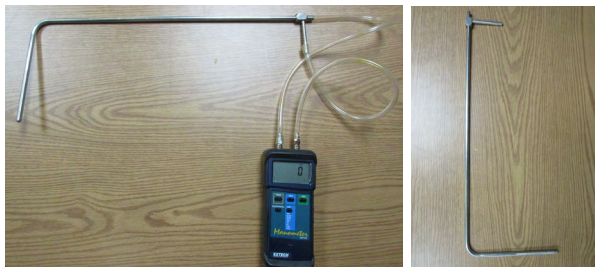
Pressure measurement using portable instrumentation in a steam system is much more difficult to undertake than temperature measurement since the steam or process fluid to be measured has to be in contact with a pressure sensing device. This will typically be difficult to carry out due to safety issues related to high temperatures and pressures. Additionally, the effort may not be justified with portable instrumentation unless this equipment is going to stay in place for a longer duration of data logging. Nevertheless, there are locations where pressure measurement is done during a steam system energy assessment using portable instrumentation such as stack (flue gas exhaust) draft, if required.

In most cases, differential pressure measurement (between total and static head pressures) is obtained using portable instrumentation. This measured velocity head can then be used effectively in certain areas such as flue gas, air, water, steam vents, etc. to gain an estimate of the flow velocity and thereby calculate an approximate flow. The portable instrumentation is very simple and consists of the following:

- Pitot tube
- Digital manometer
- Transparent flexible (vinyl) tubing

#### 11.2.2.1. Pitot Tube

A pitot tube is a very simple device which allows the user to measure the difference between the total head pressure and the static head pressure. Figure 39 provides examples of pitot tubes. It is a stainless steel tube-in-tube type configuration that has a fixed length (or can be telescopic - expandable). Pitot tubes based on their geometries come in different styles – L, S, etc. From a steam system energy assessment perspective, certain minimum requirements for the pitot tubes are provided below:



- Temperature range of up to 500°C
- Insertion length – 18 inches
- Tube diameter – 5/16 inch

Figure 39: Pitot Tubes (and Digital Manometer) used in a Steam System Assessment

#### 11.2.2.2. *Digital Manometer*

The digital manometer is required to read the differential pressure (velocity head pressure) as measured by the pitot tube. A regular water-based U-tube manometer can also be used in lieu of a digital manometer. Nevertheless, a digital manometer will be more accurate and easy to carry compared to the U-tube manometer. This digital manometer can also be used to measure draft pressure, if it lies within the range of the manometer. Typically, manometers come in different pressure ranges – from 10 inches of water column to 500 psi (35 bar) and it is very important to select the proper range for the application that it is being used to measure. From a steam system energy assessment perspective, certain minimum requirements for the digital manometer are provided below:

- Pressure range – 0-10 inches water column
- Resolution – 0.01 inches water column
- Pressure Accuracy - +/-0.5% Full Scale

#### 11.2.2.3. *Transparent Flexible Tubing*

This flexible tubing is used to connect the pitot tube ports to the respective terminals of the digital manometer. Typically, clear vinyl tubing which is flexible provides an economical means of using it in this application. The size of the tube and the port connections of the digital manometer and pitot tube should match accordingly so that there are no operational problems.

### 11.2.3. **Stack (Flue Gas) Analysis**

Stack or flue gas analysis is an extremely important measurement for an industrial steam system analysis. This measurement can be generalized and the portable instrumentation can be used for any fuel-fired equipment and it is not limited to boilers as the case would be in a steam system energy assessment. The main purpose for undertaking a stack gas analysis is to determine the operating combustion efficiency (or stack losses) for the boilers. A significant part of the boiler efficiency is dependent on the combustion efficiency and estimating boiler efficiency (using the indirect method) will require calculation of stack losses. Stack losses are dependent on the net flue gas temperature and the percent of oxygen in the flue gas stream. The stack gas analysis allows the steam energy expert to calculate these stack losses.

Portable stack gas analyzers have a metal probe that has a thermocouple and a tube to sample the flue gas. A hand-held analyzer will have a small vacuum pump that will constantly draw the sample gas to the electrochemical cells for analyzing the amount of flue gas oxygen in the stack. Portable stack gas (or flue gas) analyzers or combustion gas analyzers are available from several manufacturers and have several different functionalities and options. Figure 40 provides some pictures of the stack gas analyzers and demonstrates how they are used to undertake a stack gas analysis in a steam system assessment.

From a steam system energy assessment perspective, certain minimum requirements for the stack gas combustion analyzers are provided below:

- Digital electronic model
- Ability to measure oxygen concentration – 0-25%
- Ability to measure carbon monoxide concentration – 0-4,000 ppm
- Temperature range – up to 750°C
- Sampling pump, hose assembly with filter and water trap
- Pressure draft - +/-72 inches of water column
- Multiple fuel capability including methane, HFO, etc.
- 10 location memory storage capability



Figure 40: Use of Stack Gas Analyzers in a Steam System Assessment

#### 11.2.4. Energy Measurement

It is almost impossible to measure fuel flow rate using portable instrumentation unless it is a time-based calculation of a fixed volume of liquid or solid fuel that is consumed from a storage tank or area. Hence, there are no direct portable fuel flow measurement devices for a steam system assessment. Additionally, fuel is purchased and the industrial plant will typically have a very good metering system or access through the utility or fuel supplier to average values that are within reasonable accuracies for the steam system assessment.

Electric power measurement may be required if the steam system assessment requires sub-metering of electrical equipment such as motor-driven fans, pumps, etc. that are boiler or steam system auxiliaries. In most cases, industrial plant personnel will have electrical metering equipment which can be used but portable instrumentation in the form of an ammeter or a power meter would be required for electrical energy usage and demand measurement. Commercially, there are several different kinds of power measurement portable instrumentation (see Figure 41) available and the minimum requirements for that equipment should be:

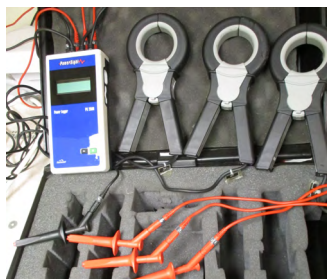


Figure 41: Portable Power meter for use in a Steam System Assessment

- Ability to measure single-phase and three-phase True Power (kW), Apparent Power (kVA) and Reactive Power (kVAR), Power Factor
- Maximum and minimum recording with elapsed time indication
- Auto Detect AC/DC Voltage
- Ability to measure up to 660 V

### 11.2.5. Other Measurements & Auxiliaries

There are other measurements which can be taken during an industrial steam system assessment and that may require portable instrumentation and auxiliaries to assist in the measurements. Some of these portable instruments are also used by maintenance personnel and servicing contractors for their routine maintenance and upkeep of the utility system. This section summarizes such portable instrumentation and auxiliaries.

#### 11.2.5.1. *Ultrasonic Leak Detector*

The ultrasonic leak detector is mainly used as an acoustic technique to check steam trap performance and inspect them periodically. From a steam system energy assessment perspective, it is expected that the energy experts understand its use and that it is a “good to have” portable instrument. Nevertheless, it should be realized that a steam systems optimization is not equivalent to undertaking a detailed steam trap inspection at the plant. It is an expensive instrument and will require training prior to being used effectively in the field for detecting steam trap failures. Although mentioned here, it serves a dual purposes and can also be used to detect compressed air leaks. Hence, it is a good portable instrument to have in the kit if the energy expert’s focus is more specific to leak detection and steam trap failures. It comes with different probes – scanning modules, a stethoscope module and long range modules and will require noise attenuating head phones.

#### 11.2.5.2. *Digital Stopwatch*

A digital stopwatch is an absolute must for an industrial steam system energy assessment. It is an easy way to get a time stamp when working with totalizers to get a quick understanding of flow rates. It can be used to determine ON/OFF cycle times of processes which can aid in understanding duty cycles in the field. There are several other examples which can be cited for using a digital stopwatch in an industrial steam energy assessment.

#### 11.2.5.3. *Digital Camera*

A digital camera is a very handy tool and allows the energy expert to specifically pinpoint opportunity areas while in a discussion with plant personnel and in the assessment reports. Additionally, it allows the energy expert a virtual capability of the opportunity and plant areas while working on the assessment and on any future projects. Nevertheless, several plants will restrict the use of cameras in their premises and will require prior management permission to take pictures in the plant. Hence, it is important that the energy expert clarify these issues with plant personnel before starting the onsite energy assessment. Digital cameras come in several models with several functionalities. The specifications and requirements of a digital camera are left to the user and as technology changes these will change too.

#### 11.2.5.4. *Gloves*

Gloves fall within the category of safety equipment and may be provided by the plant as personal protective equipment. They are mentioned here specifically to ensure that when working with hot surfaces and electrical equipment the energy expert has the right safety gear. The gloves should be rated for usage with 1,000 V supply.

#### 11.2.5.5. *Flashlight*

A compact industrial-grade flashlight should be carried by all energy experts. There are several locations where proper lighting is not available in industrial plants and being able to accurately see through sight glasses, level indicators, etc. and being able to read in-situ local indicators is very important. A flash light is an important tool to have available at all times.



#### 11.2.5.6. Batteries

Almost all the electronic portable instrumentation requires some form of batteries. It is typically difficult to carry specific-instrumentation rated batteries for all the instruments but it is essential to carry spare batteries that can be replaced while in the plant and doing an energy assessment. Most instruments come with their own batteries and charging systems and sometimes it is not possible to have a spare. Nevertheless, energy experts should ensure that they carry spare batteries for all their portable instrumentation and frequently charge batteries that are rechargeable and instrument-specific.

#### 11.2.5.7. Insulation Tape

The classic black insulation tape can be used in the event that any electrical connections need to be opened for electrical measurements. Alternatively, the black tape provides a very good way to get an accurate temperature spot reading on a surface that may have a very different emissivity. The insulation tape can also be used as an indicator to pinpoint an opportunity or area of concern while taking a photograph.



## 12. STEAM SYSTEM ASSESSMENT REPORT

---

It is expected that after the completion of an industrial steam system assessment, the steam system expert will present a report to the industrial plant personnel. This report can take several forms but at a minimum there should be a wrap-up meeting at the end of the assessment in the plant. This should then be followed up by a detailed Steam System Assessment Summary Report. This section of the Experts Training Manual provides an insight to the readers about the reporting modalities of the steam system assessment.

### 12.1. Steam System Assessment Wrap-Up Meeting

There are several reasons to do a steam system assessment wrap-up meeting and some of those are listed below:

- Provide an overview of the objectives and mission of the steam system assessment
- Confirm all the assumptions, utility pricing, production information, etc. to be used for quantifying the energy and economic benefits of potential optimization opportunities
- Ensure that all the plant personnel agree with the steam assessment preliminary findings
- Finalize the list of potential steam systems optimization opportunities to be captured in the final report so that there are no surprises to plant personnel
- Get buy-in from plant management to complete additional due-diligence (modeling, project cost estimation, etc.) on the preliminary findings
- Get approval to complete final report and determine timelines and protocol for review of the report by plant personnel

The energy expert should make every effort to ensure that this wrap-up meeting at the end of the steam system energy assessment is face-to-face with plant personnel and is attended by plant management, decision makers for the implementation of projects and all the plant personnel who participated in the energy assessment site work. As mentioned before, the wrap-up meeting should be used to get buy-in from everyone present on the list of the improvement opportunities that were identified during the assessment.

The best way to organize this wrap-up meeting is to schedule it prior to the start of the assessment and invite all the people who should be involved in this meeting. Additionally,



a conference room with an overhead projector and a white-board (black-board) or a flip-chart should be available for this wrap-up meeting. The steam system energy expert should prepare a “PowerPoint” type presentation to facilitate this wrap-up meeting. The wrap-up presentation, at a minimum, should include the following:

- Overall goals of the steam system energy assessment
- Participants (team members) of the assessment
- Results of the Steam System Scoping Tool (level of BestPractices already in the plant)
- List of potential optimization opportunities in the steam system
- Brief description of the opportunities with, possibly, identification of those opportunities being short-term (no cost or minimal cost), mid-term (1-3 year paybacks) and longer-term (involving capital expense and/or greater than 3 years payback)
- Indication of next steps and timeline

## **12.2. Steam System Assessment Final Report**

The steam system assessment final report is the document that sets down everything about the assessment and the results. There is no set format or template for the assessment final report but it is expected that it be comprehensive enough for the plant personnel to understand the data gathered, analysis conducted and the quantification of the identified potential optimization opportunities. Additionally, the report should have qualitative recommendations or opportunities that were identified but need additional due-diligence before quantifying their benefits. The general sections of the report (as typically prepared for US Department of Energy steam system assessments) with a brief description and example (wherever possible) is presented below.

### **12.2.1. Title Page & Introduction**

A title page identifying the report version (Draft or Final), date of submission, plant name and location should be the first page of the report. It should typically be stamped “Confidential” since the report may contain sensitive and proprietary information about the steam system and/or plant.

An introduction page provides general information about the plant, address, contact information and the team involved during the assessment. It can also have additional details such as facility area, hours of operation, etc. A brief example is shown in Table 9 below.

### **12.2.2. Executive Summary**

An executive summary provides a quick overview and a very high level view of the assessment findings without getting into the details. It serves as an interest grabber and in most cases it is used to get the attention of plant management and decision-makers. The Executive Summary should be limited to no more than a page and most likely should have three or four paragraphs providing information on the following:

- Main goal of the assessment
- When was it conducted and who was the principal investigator (individual or company)



- Information about overall BestPractices existing in the plant currently and possibly how well the plant performs in comparison to industry standards in general
- An approximate total of the energy and cost savings possible if all the quantifiable optimization opportunities are implemented
- An approximate cost (or payback period) for implementation of these identified opportunities
- A brief overview of qualitative recommendations
- Possible next steps

**Table 9: Introduction Information in a Steam System Assessment Report**

General Assessment Information			
Company:	ABC Refining Company	Assessment Type:	Steam
Plant:	ABC Refinery	Assessment Dates:	August 23-26, 2010
Plant Information			
Industry Code:	324110	Employed:	1800
Principal Products:	Petroleum Refining	Plant (or Facility) Area:	125 acres
Address:	Houston, TX, USA	Annual Hours of Operation:	8760
Participant Contact Information			
Plant Contact		Energy Expert Contact	
Name:	John Smith	Name:	Riyaz Papar, PE, CEM
Title:	Energy Engineer	Company:	Hudson Technologies Company
Phone:		Phone:	1 (281) 298 0975
Email:	jsmith@ABCrefinery.com	Email:	rpapar@hudsontech.com
Corporate Contact		Energy Manager Contact	
Name:		Name:	John Doe
Phone:		Phone:	
Email:		Email:	jdoe@ABCRefinery.com
Additional Plant Attendees			

### 12.2.3. Summary Table of Energy Optimization Opportunities

The summary table of energy savings opportunities leading to system optimization provides an easy-to-understand line-item identification of each opportunity and its energy and cost impacts. Table 10 presents an example of the summary table. One of the columns shown delineates impact on CO<sub>2</sub> emissions. This is very much fuel-dependent and the factors of electricity can vary from region to region. If the emissions are included, the methodology of calculation should be presented as a footnote to the Table.



**Table 10: Example – Summary Table of Energy Optimization Opportunities**

Assessment Opportunities		Estimated Annual Savings					Simple Payback (years)
ESO#	Recommended Opportunities	MWh	kW	GJ	CO <sub>2</sub> (Metric Tons)	Cost Savings (\$)	
1	Reduce number of operating boilers	0	0	40,200	2,134	165,500	0.0 - 0.2
2	Install VFDs on FD and ID fans of boilers	12,500	1,400	0	7,749	712,500	0.9 - 1.4
3	Implement blowdown heat recovery	0	0	53,600	2,846	220,500	0.5 - 0.7
4	Install backpressure turbine on CT pump	8,750	1,000	(43,000)	3,141	328,000	1.2 - 2.3
<b>Total</b>		<b>21,250</b>	<b>2,400</b>	<b>50,800</b>	<b>15,870</b>	<b>1,426,500</b>	<b>0.8 - 1.4</b>

### 12.2.4. List of Qualitative Recommendations

Depending on the level of due-diligence and the scope of the steam system energy assessment, energy experts may not be able to quantify the energy and cost savings from all the possible opportunities. Sometimes it may need a much more thorough process understanding which the expert may not necessarily have. Some of these opportunities may be very good opportunities when large infrastructure changes are going to be incorporated at the plant. Hence, in an effort to outline these opportunities in one place, this list serves as a very valuable piece of information for the plant. Additionally, BestPractices as related to maintenance and proper energy management can also be listed here since it is difficult to calculate actual energy and cost benefits from these activities. Table 11 provides a sample of the Qualitative Recommendations from a steam system assessment report.

**Table 11: Example – List of Qualitative Recommendation**

1.	Use high pressure boiler to make steam before using low pressure boiler
2.	Make a low pressure (20 psig) steam header to be used for process water heating
3.	Install a condensing turbine generation section in the Plant
4.	Improve the Plant's condensate return
5.	Implement automatic boiler blowdown control
6.	Implement intelligent soot blower controls on the Recovery Boiler
7.	Develop a steam balance and power generation model for the Plant
8.	Calibration of in-situ instruments
9.	Use portable instruments for day-to-day investigations in the Plant
10.	Continue monitoring and trending equipment efficiency



### 12.2.5. General Observations, Assumptions & Data Collection

The General Observations, Assumptions & Data Collection portion is the first section in the body of the report and is expected to be no more than two pages. Its main purpose is to provide an understanding of the plant as a whole. This section should cover information about the overall operations at the plant, utility information and costs, operating hours, schedules, etc. Results from the Steam System Scoping Tool (SSST) should be provided in this section.

This section should also contain all the assumptions that were made by the energy expert during the assessment. This can include information on how the operating profile of the plant was conceived and what seasonality and production assumptions were made to build models, etc.

Data collection refers to information as regards to what data was collected and how it was collected. Some of the data can be spot checks with hand-held instrumentation. On the other hand, process and utility data can be obtained from a historian. This data can be averaged over a 5-minute, hourly, 6-hourly, daily, etc. periods. It is important for the energy expert to identify the sources of the plant operating data so that the results and analysis from the assessment can be repeated by the plant personnel or a third-party.

### 12.2.6. Steam System Overview

As the name implies, this section provides an understanding of the steam system at the plant. It should provide detailed information about the steam system, including but not limited to:

- Boilers - design conditions, rated capacities, fuels, etc.
- Distribution system - header pressures, design flows, pressure reducing stations, etc.
- Steam turbines and generators - design conditions, rated capacities, etc.
- Condensate system
- Deaerators – design conditions
- Water treatment capability
- Specific steam end-uses – major process users, direct injection steam, etc.

This section can also include histograms showing steam flows from different boilers over certain time periods (for example: annually), steam turbine power generated over a certain time period, etc. Information provided in this section mostly comes from the raw data that is collected. This section can also include block and line diagrams showing the overall steam system at the plant. A Process Flow Diagram (PFD) or a Piping & Instrumentation Diagram (P&ID) representing the overall steam system can also be included in this section or in an appendix of the report.

### 12.2.7. Steam System Operating Performance & Efficiencies

This section contains all the results obtaining from the calculations carried out during the assessment as related to calculation of the operating performance and efficiencies of all the critical equipment in the steam system. These include all the boilers, steam turbines, heat exchangers. Most of the information in this section will be graphical or tabulated. The main purpose of this section is to enable an understanding of the plant's steam system operations and the possible areas of efficiency improvement and optimization.



All the information in this section is derived from thermodynamic analysis and models using steam properties, mass balances, energy balances, etc. For example, boiler efficiencies are calculated from first principles (fuel flow rate, HHV of fuel, steam flow rate, enthalpies of steam and feedwater). Alternatively, boiler efficiencies are also calculated indirectly by calculating the different losses from the boiler: stack loss, shell loss, blowdown loss, etc. Similarly, steam turbine calculations such as steam turbine efficiency, steam rate (kg/hr/kW) should be presented in this section. Figure 42 presents an example of the steam turbine efficiency calculations with respect to power generated. This section can also contain information related to major steam users and metrics such as steam used per ton of product produced.

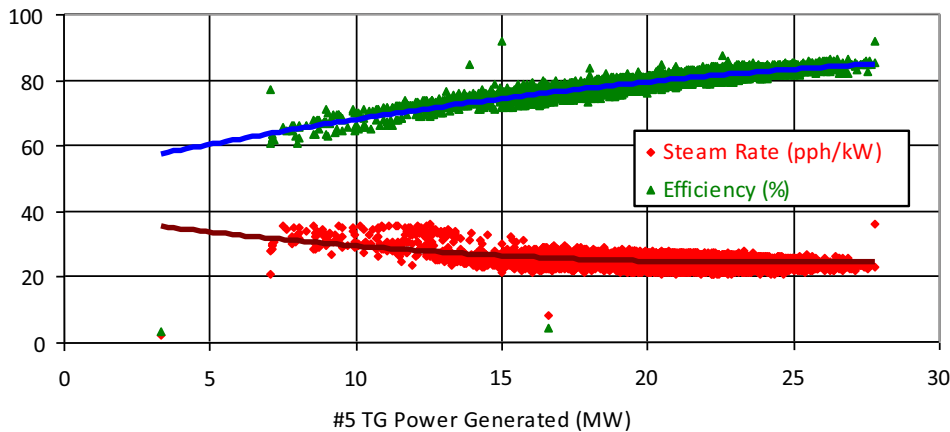


Figure 42: Example – Steam Turbine Operating Efficiency Curve

### 12.2.8. Steam System Model

This section should contain the steam balance model (Steam System Assessment Tool) that has been developed and used for the analysis of the steam system operations as shown in Figure 43.

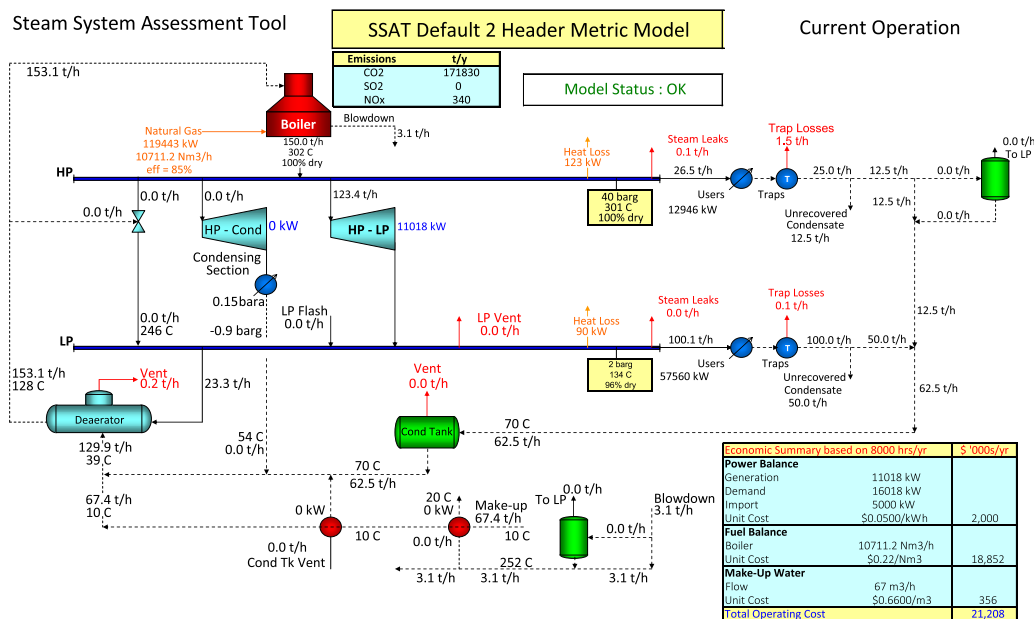


Figure 43: Example – Steam System Model

### 12.2.9. Observed BestPractices in the Plant

This section details all the current BestPractices already in place in steam system operations. It is very important to recognize BestPractices found in the industrial facility to ensure that they are not discontinued in the future. Secondly, plant personnel deserve credit for following these BestPractices and this section recognizes their efforts. Lastly, this section also serves to inform plant personnel to undertake these BestPractices in future plant expansions as well as implementing them in other plants belonging to the same enterprise or corporation.

Each identified BestPractice should be briefly described with a statement or two about the application. Some examples of BestPractices and their basic descriptions that could be included in the assessment report are provided below:

#### **Overall site level integration**

Steam is generated centrally in the Powerhouse and Recovery areas and is then distributed via a site-wide steam header network and integration.

#### **Significant instrumentation for energy balance analysis**

There is a significant amount of instrumentation that monitors critical operating parameters and a historian system that helps plant personnel to do a steam, condensate and energy balance.

#### **Evaluation of key performance indices**

Plant personnel continuously monitor and evaluate key performance indices especially on critical equipment such as recovery boiler, turbine generators, etc.

#### **Feedwater Economizers / Air-Preheaters on all the boilers**

The plant has air-preheaters on high pressure boilers. Other boilers have feedwater economizers. This heat recovery equipment on all the boilers captures heat from the flue gas and improves boiler efficiency.

#### **Blowdown flash steam recovery**

The Plant has blowdown flash steam recovery on all the boilers. Flash steam is recovered from the blowdown at 1.5 bar. This heat recovery improves boiler / system efficiency.

### 12.2.10. Energy & Cost Saving Optimization Opportunities in the Plant

This section of the assessment report is the most important section from the perspective of the value of the energy assessment. It discusses all the optimization projects that would result in energy and/or cost saving opportunities, which would then directly lead to steam systems optimization in the plant. Any optimization activity is associated with specific goals. Most often all these goals may not be met and the plant will need to take a Pareto approach to identifying what opportunities and projects to implement. It is very important to state these project goals in this section of the assessment report because it provides the plant with an understanding of what objectives and targets were used to arrive at these optimization opportunities. Some typical goals for identifying optimization opportunities in the steam system are:



- Minimize total utility operating cost for the plant
- Maximize operating thermal energy efficiency of the steam system
- Projects with no or minimal initial cost (low hanging fruit) and having quick payback periods
- Maximize reliability of operations and enhance stability in operations of the steam system
- Minimize dependence on the utility grid for the plant's overall electrical power demand
- Projects that are sustainable with proper maintenance BestPractices
- Minimize greenhouse gas emissions at the plant site and/or globally

Each opportunity should be identified starting on a new page and should follow the order as they are listed in the Summary Table of the Energy Optimization Opportunities. The main sections of each of the Energy Optimization Opportunity (EOO) write-up are:

### **Title & Number**

Each EOO should have a unique number and a brief title describing the opportunity. It can be a generic title or can be as specific to the plant and equipment.

### **Optimization Opportunity Table**

The optimization opportunity table will have quantified information on the individual energy and cost savings of the electrical energy, fuel, etc. as well as the total (net) quantified savings. Unless otherwise required, it is best to represent all this data on an annual basis. The opportunity table should also contain potential project costs with a highest and lowest projected figure. The costs may be a first level estimate either based on past experience with such projects, preliminary vendor discussions, etc. A payback period should also be calculated based on these cost numbers and net savings possible. Lastly, greenhouse gas reductions in terms of CO<sub>2</sub> savings can also be reported in this table.

### **Background Information**

The background information provides a description of the current operation or situation at the plant specific to the optimization opportunity area. This section can be descriptive (in words only) but can include pictures from the plant, graphs, line diagrams, etc.

### **Recommendation**

The recommendation sub-section details in simple layman's terms just how this optimization opportunity may apply at the plant and what would be required for the plant to realize the energy and cost savings.

### **Estimated Savings Methodology**

This sub-section describes the methodology used to estimate the energy and cost savings from implementing the EOO at the plant. Most of the time these will refer back to the steam system thermodynamic models developed, such as the SSAT or any other software tools that may have been used. The estimated savings methodology can also refer to published information from reliable sources such as text-books, technical papers published in journals, etc. Manufacturers' recommendations and savings estimates can be used as a last resort but they have to be qualified in this sub-section. It is expected that the steam system energy expert at least complete a sanity check before using a manufacturers' recommendation to determine the estimated savings.



### **Implementation Costs and Simple Payback**

Implementation costs require a significant amount of due-diligence and will be difficult to calculate within the scope of the steam system energy assessment. Nevertheless, it is worthwhile to provide a range from low to high cost for implementation of the EOO at the Plant. This sub-section provides some guidance as to how these implementation costs are estimated. A major source for estimating these implementation costs can be manufacturers' information (catalogs, brochures, web-sites). In several cases, past experience of energy experts in project implementations can provide very good information. Plant personnel and contractors can also be a valuable source for project implementation costs. It should be noted that implementation costs for the same project can vary significantly based on the industry, local regulations, etc.

A simple payback period range can now be calculated and provided. It is intended that no cost / low cost projects that have almost immediate paybacks should be projects of the first priority. These may be termed Near-Term Projects. Projects with a 1-3 year payback period are Mid-Term Projects and projects with payback periods exceeding 3 years are Long-Term Projects.

### **Next Steps for Implementation**

In most instances, plant personnel have several responsibilities and they may not have the ability to focus on implementing EOO's in the plant. Hence, it is necessary for the EOO write-up to provide next steps and guidance to plant personnel on each of the energy and cost savings implementation projects. This can be a very detailed section with possible identified action items, quotes from vendors, etc. On the other hand, it can be a very simple sub-section giving direction to plant personnel as to follow up for additional due-diligence, etc.

A few examples of write-ups of EOO are presented in the Tables 12-14. They are not specifically related to any particular assessment and are provided here for an energy expert to use as a possible template in their steam system energy assessment report.

## **12.2.11. Qualitative Recommendations & Best Practices for the Plant**

Qualitative Recommendations (QR) provide information on those energy optimization opportunities that were identified during the assessment that should be considered for further investigation and implementation. However, due to lack of measurements, information, and/or lack of resources during the assessment, specific energy and cost savings are not quantifiable at the end of the assessment. Qualitative Recommendations can also be those "out-of-the-box" optimization opportunities that need to be revisited whenever any major infrastructure (utility or process) upgrade is considered for the plant. Qualitative Recommendations may also include potential industry best practices to be incorporated into the plant. In effect, the Qualitative Recommendations area serves as a place to collect all the ideas that may have been brainstormed by the energy expert and plant personnel during an energy assessment. It is vitally important to set these down and not lose them.

Each Qualitative Recommendation should be identified by a unique number, have a title and a brief description. Some examples of Qualitative Recommendations are provided in Table 15.



**Table 12: Example – Energy Optimization Opportunity Write-up**

<b>EOO # 4 : Install feedwater economizers for Low Pressure boilers – B1 and B2</b>						
	<b>Estimated Annual Savings</b>			<b>Estimated Project Cost</b>		<b>Simple Payback (years)</b>
	Resource	CO <sub>2</sub> (metric ton)	Dollars	Low	High	
Natural Gas	61,500 GJ	3,266	\$253,500			
<b>Total</b>		<b>3,266</b>	<b>\$253,500</b>	<b>\$600,000</b>	<b>\$750,000</b>	<b>2.4 - 3.0</b>

**Background**

The Low Pressure (LP) boilers – B1 and B2 do not have any feedwater economizers. These boilers typically operate at minimum loading conditions and even then stack temperatures for the LP boilers are 270°C and 267°C, respectively. These temperatures are extremely high when compared to other LP boilers in the plant, which operate at the same pressure but with stack temperatures ~165°C.

**Recommendation**

It is recommended to install feedwater economizers in LP boilers – B1 and B2 to improve overall boiler and Power House steam generation efficiency.

**Estimated Savings**

The energy savings are estimated based on the current operating conditions for LP boilers – B1 and B2. The energy savings result due to increase in B1 and B2 boiler efficiency due to reductions in stack temperatures from 270°C and 267°C, respectively to ~175°C. This results in B1 boiler efficiency changing from ~79.2% to ~82.7% and B2 boiler efficiency changing from ~79.7% to ~82.7%. All these numbers are calculated at 6% flue gas oxygen. Total annual energy savings are ~61,500 GJ equivalent to an annual cost savings of ~\$253,500.

**Implementation Cost and Simple Payback**

Although packaged economizer bundles are now available from several manufacturers, this EOO will require detailed engineering and pressure drop calculations through the stack. It is anticipated that the installed economizer cost will be ~\$350,000 per boiler. Simple payback is expected to be 2.4 – 3.0 years.

**Next Actions Towards Implementation**

Plant personnel need to work with the original boiler manufacturers and possibly economizer manufacturers to determine heat exchange area requirements, pressure drops, size and cost estimates for installing feedwater economizers in LP boilers – B1 and B2.





**Table 13: Example – Energy Optimization Opportunity Write-up**

EOO # 9 : Install backpressure turbines on cooling tower water pumps						
	Estimated Annual Savings			Estimated Project Cost		Simple Payback (years)
	Resource	CO <sub>2</sub> (metric ton)	Dollars	Low	High	
Electrical Energy	8,750,000 kWh	5,424	\$505,000			
Electrical Demand	1,000 kW	-	-			
Natural Gas	(43,000) GJ	(2,283)	(\$177,000)			
<b>Total</b>		<b>3,141</b>	<b>\$328,000</b>	<b>\$400,000</b>	<b>\$750,000</b>	<b>1.2 - 2.3</b>

**Background**

The 18/4 bars pressure letdown station in the refinery typically has steam flow around 70 Tph. These letdown stations are in the process areas.

**Recommendation**

It is recommended to convert one or two electrical motor driven cooling tower water pumps in the process areas to steam backpressure turbine-driven pumps.

**Estimated Savings**

Although steam flow is ~70 Tph and can result in generation of ~2,300 kW of shaft power, energy savings are estimated for generating ~1,000 kW of shaft power. This would be equivalent to replacing one or two cooling tower water pumps. Annual electrical energy savings are estimated to be ~8,750,000 kWh; Demand savings ~1,000 kW; and fuel increase of ~43,000 GJ. The annual net cost savings are ~\$328,000.

**Implementation Cost and Simple Payback**

The estimated implementation cost is expected to be ~\$400,000 to \$750,000.

**Next Actions Towards Implementation**

Plant personnel should ensure that the steam flow through the pressure reduction stations is continuous and exists all year round. Additionally, plant personnel should look for additional electrical motor driven equipment that can be converted to backpressure steam turbine driven equipment.



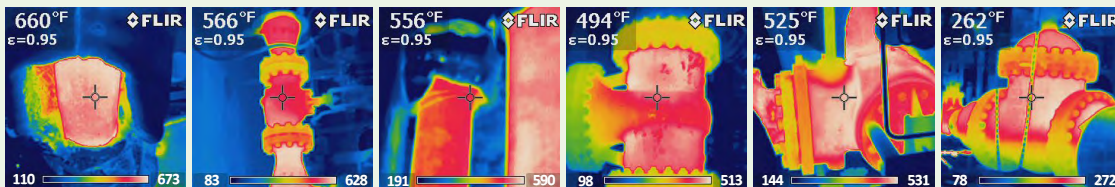


**Table 14: Example – Energy Optimization Opportunity Write-up**

EEO # 12 : Improve steam system insulation plant-wide						
	Estimated Annual Savings			Estimated Project Cost		Simple Payback (years)
	Resource	CO <sub>2</sub> (metric ton)	Dollars	Low	High	
Natural Gas	75,000 GJ	3,980	\$300,000			
<b>Total</b>		<b>3,980</b>	<b>\$300,000</b>	<b>\$50,000</b>	<b>\$300,000</b>	<b>0.2 - 1.0</b>

### Background

Steam temperatures can be as high as 450°C (in the Power House) or 350°C (in the plant). During the plant walk-through there were several areas that were identified which could benefit significantly with insulation. Additionally, insulation also needs to be implemented to ensure plant personnel safety. Some infra-red pictures taken during the assessment are presented below.



### Recommendation

Perform a plant-wide insulation energy appraisal / audit. This audit should include infra-red thermography on boilers, steam distribution and piping, turbines, process equipment, etc. Identify insulation priorities based on energy cost and use economic thickness calculator in the 3EPlus insulation software.

### Estimated Savings

Insulation heat loss was determined by the 3EPlus program and the US DOE SSAT 3-header model was used to quantify the energy savings. For example, a 12-inch uninsulated pipe costs ~\$2,500/m/yr; a 4-inch uninsulated pipe costs ~\$1,000/m/yr; and an uninsulated flat vertical surface costs ~\$2,500/sqm/yr. These numbers are based on typical plant steam temperatures. A GROSS ESTIMATE for energy savings based on inspected insulation during the assessment is provided here. Annual energy savings of ~62,000 GJ equivalent to cost savings of ~\$255,000 can be possibly realized by adding or repairing insulation plant-wide.

### Implementation Cost and Simple Payback

Insulation projects typically have immediate and very fast paybacks and in most cases in less than one year. But implementation costs can vary significantly depending on type of insulation, location, complexity, etc.

### Next Actions Towards Implementation

The plant needs to conduct a detailed insulation audit / appraisal and add insulation and/ or repair insulation, as required plant-wide.



**Table 15: Examples of Qualitative Recommendations Write-up**

**QR 1: Make a low pressure (1.5 bar) header to be used for process water heating**

It has been observed that process water heating in the Plant uses steam from the 3.5 bar header whereas it can easily be done with much lower pressure steam (1.5 bar). The Plant does not have an existing 1.5 bar header and will need to install a brand new header or convert certain sections of the 3.5 bar header into a 1.5 bar header. This recommendation can also be made along with several infrastructure changes such as:

- Reducing deaerator operating pressure
- Reconfiguring #1 Turbine Generator to exhaust at a much lower pressure or installing a new turbine to exhaust at the lower header pressure
- Isolating process loads to ensure that the lowest pressure steam is used for all the end-uses

The benefits of this recommendation include:

- It will reduce the pressure drop on the 3.5 bar header
- Increase power production in the Plant
- Optimize the system and provide alternatives for steam system balancing and redundancy

**QR 2: Improve the Plant's condensate return**

There are several areas which need to be targeted for condensate recovery and condensate should be collected from those areas and returned to the Powerhouse and Recovery area. Current condensate return is measured at 60%. The US DOE SSAT model provides a good first level estimate for the Plant. Based on the model developed for the Plant, an improvement in condensate return of 0.63 liters/sec on 3.5 bar header, results in annual cost savings of ~\$15,000. Hence, it is recommended that a detailed condensate study for the Plant be conducted.

**QR 3: Calibration of in-situ instruments**

For any assessment as well as trouble-shooting and performance improvement, instrumentation is the key to success. Hence, Plant personnel should develop a protocol to inspect and calibrate flow-meters, temperature and pressure sensors on a periodic basis. During the assessment at the Plant, data was collected from the energy expert and Plant personnel did find some important data points which were not reading correctly or were causing an issue with the set-up of the system.

**QR 4: Use portable instruments for day-to-day investigations in the Plant**

It is recommended that the Plant use the following portable instruments for the steam systems optimization program:

- Infra-red temperature camera
- Pitot-tube and dP sensor for steam leaks, vented steam, etc.

**QR 5: Continue monitoring and trending equipment efficiency**

The Plant has several production and unit operations that use steam and as the Plant advances towards achieving higher energy efficiency levels, it will be prudent to establish benchmarks for steam system equipment (such as Turbines, Boilers, etc.) based on steam usage versus production. In the long run, this will ensure lowest cost of operation. Some other critical parameters that need to be monitored or calculated and trended include: Boilers - stack temperature, excess oxygen, steam flows, etc; feedwater economizer effectiveness; and steam turbine efficiency.

## 13. CASE STUDIES

---

Typically, steam systems optimization energy assessments lead to projects and implementation. It is extremely important to set down the success stories and the lessons learned in an informative manner so that it can be disseminated to the industry. In the industry, most times the philosophy followed is “We want to be the first to be the second”. In simple layman terms this implies that industry only wants to implement proven technology which has a track record. Typically, no industry wants to be a test-bed for trying out new (or risky) technology which may predict very good energy and cost savings but if the technology fails to prove itself can then result in dire consequences leading to a disruption in production and Plant upset or shutdown scenarios.

Case studies help to impart significant knowledge about a technology, process, BestPractices, implementation cost information and important lessons learned by others who may have successfully implemented steam systems optimization at their plants and facilities. Case studies can be used to prove to management that the quantified energy and cost savings in the steam system optimization report are achievable and proven in other similar (or different) industry sectors.

This section contains a few examples of select case studies that were developed from steam system optimization assessments conducted by the authors. The first set of case studies was published by the US DOE under the Save Energy Now Program during the period from 2005-2010. Some additional case studies are also presented to provide a diversification of applications and understanding of complexities, especially when projects combine both process and utility streams. There are numerous case studies available and published in trade magazines, conference proceedings, equipment manufacturer’s literature, etc. The steam system energy experts are expected to know about the state-of-the-art applications and technology by ensuring that they read available literature and understand the applications and lessons learned.



## 13.1. Case Study #1 – DOW Chemical Company

*This Case Study is excerpted from published US DOE literature. The full document is available from the US DOE's website.*

### 13.1.1. Summary

In late 2005, a US DOE Save Energy Now energy assessment was performed at Dow Chemical's St. Charles Operations petrochemical plant in Hahnville, Louisiana. The main objective was to identify opportunities for natural gas savings in the plant's steam system. The assessment, performed by US DOE Energy Expert Riyaz Papar of Hudson Technologies, quantified several opportunities for increasing steam system efficiency. By capitalizing on some short-term opportunities, the St. Charles plant achieved impressive natural gas savings. The personnel at the St. Charles site improved their steam trap program and enhanced their ongoing leak repair campaign. Although Dow Chemical was aware that the efficiency of these systems could be improved, the assessment quantified the potential energy savings in a manner that made a more compelling case for implementing the improvements. The combined annual energy and cost savings resulting from these two measures amount to 272,000 GJ and \$1.9 million, respectively. With project costs of approximately \$225,000, the simple payback was around six weeks.

### 13.1.2. Company & Plant Background

Dow Chemical Company is a diversified company that offers a wide range of chemical, plastic, and agricultural products and services in many essential consumer markets. With customers in more than 175 countries and 42,000 employees around the world, the company has annual sales of \$46 billion. Over the past 30 years, Dow has been proactive about energy efficiency. In 2005, the company established a goal of improving its energy intensity by 25% by 2015. Formerly owned by Union Carbide Corporation, the 2,000-acre St. Charles facility has been in operation since 1966 and produces glycol ethers and amines. With nearly 3,000 employees, the St. Charles site produces ~5 million tons of these intermediate chemical products annually. Because steam is required for many processes—including electricity generation, distillation, evaporation and concentration, process heating, and catalytic cracking — it is critical to the site's production.

Once the data collection was complete, the assessment team evaluated the steam system using SSAT and identified several energy efficiency opportunities. The team then calculated the expected savings and payback periods for each opportunity and divided them into near- and medium-term opportunities based on payback periods.

### 13.1.3. Near-Term SSO Opportunities

#### 13.1.3.1. Implement a Steam Trap Repair Project

A recent steam trap audit performed before the assessment took place identified all failed steam traps. An accurate estimate of steam leakage stemming from the failed traps was generated by inputting the number of failed traps into the SSAT and modeling the impact of implementing a steam trap repair project. Annual savings in natural gas and costs were estimated to be 112,128 GJ and \$881,000, respectively.



#### *13.1.3.2. Improve the Steam Leak Management Program*

The amount of steam lost to leaks in the system was estimated in the SSAT by subtracting the amount of steam used in the applications from the total amount of steam generated. The Save Energy Now assessment initially showed that repairing all of the plant's steam leaks could yield annual energy and cost savings of up to 451,100 GJ and \$3.3 million. However, subsequent data collection revealed that some steam meters were not functioning optimally and that parasitic demand from other plant assets accounted for a significant portion of the estimated leak load, thus reducing the potential for energy savings.

#### *13.1.3.3. Improve Insulation*

During an inspection of the plant, several areas of the steam distribution network were found to lack sufficient insulation. Using 3EPlus, US DOE's insulation calculation program, the team estimated total insulation losses to be approximately 1.0%. By reducing these insulation losses to 0.1%, the assessment showed that annual natural gas and cost savings of 3,030 GJ and \$25,000 could be achieved.

#### *13.1.3.4. Increase Condensate Recovery*

At the time of the assessment, about half of the low-pressure condensate was being recovered. Based on the analysis done using the SSAT, a condensate recovery rate of 75% was found to be possible for the entire site. Annual natural gas and cost savings from the increased condensate recovery were estimated at 87,600 GJ and \$649,000.

### **13.1.4. Medium-Term SSO Opportunities**

#### *13.1.4.1. Install a Blowdown Heat Recovery Exchanger*

Although the blowdown was being sent to a flash tank to recover low-pressure steam, the energy assessment found that significant amounts of thermal energy were being lost because there were no heat exchangers in the blowdown systems. By installing a heat recovery exchanger upstream of the blowdown tank, significant heat from the blowdown water could be captured and used to preheat boiler make-up water. The assessment estimated annual natural gas and cost savings resulting from the use of a blowdown heat recovery exchanger at approximately 31,000 GJ and \$200,000.

#### *13.1.4.2. Preheat Reactor Feed with 5 bar Steam*

The assessment found that some of the heat needed to preheat the reactor feed from ambient to reaction temperatures could be supplied by 5 bar steam instead of depending only on the 40 bar steam generated at the site. While this opportunity would not save natural gas, it could allow additional electricity generation from the 40 bar steam that was not being used to preheat the reactor feed. This could reduce electricity purchases, leading to estimated annual electricity and cost savings of 1,277 MWh and \$79,000.

#### *13.1.4.3. Install a Back-Pressure Turbine Drive*

Although the site generates steam at 40 bar, most applications require steam at 13.5 bar. The assessment found that, by installing a back-pressure turbine drive, the chemical plant could generate enough electricity to serve some of its specific critical powered equipment. Annual electricity and cost savings were estimated at 1,946 MWh and \$121,000.



### 13.1.5. Results

The implementation of some Save Energy Now assessment recommendations with short paybacks is already yielding important energy savings. By repairing steam leaks and replacing nonfunctional steam traps, the St. Charles plant was able to reduce energy costs and improve process efficiency. The steam trap retrofit resulted in annual energy savings of 109,000 GJ and energy cost savings of approximately \$792,000. The steam leak repairs resulted in annual energy savings of 163,000 GJ, worth a little more than \$1.1 million. Total annual energy and energy cost savings were 272,000 GJ and \$1.9 million, respectively. With total implementation costs of approximately \$225,000, the simple payback is slightly more than six weeks. In the future, Dow may pursue some other opportunities identified in the Save Energy Now assessment. While the implemented measures and the resulting energy savings are significant, another important result of the Save Energy Now assessment is the permanence of both measures. Steam trap maintenance and leak management are now ongoing programs. As a result, steam leakage from failed traps or fissures in steam headers are identified and repaired in real time. In addition, Dow is sharing the results of the SSAT-based analysis from the Save Energy Now assessment at the St. Charles plant with its other facilities that use steam.

## 13.2. Case Study #2 – Chrysler Corporation

*This Case Study is excerpted from published US DOE literature. The full document is available from the US DOE's website.*

### 13.2.1. Summary

In July 2006, a Save Energy Now plant energy assessment was conducted for Chrysler at the company's truck and minivan assembly complex in St. Louis, Missouri, USA. The main purpose of the assessment was to analyze the complex's steam system and identify opportunities for natural gas savings. In addition, the assessment was conducted to familiarize the complex's employees with the US DOE suite of steam system assessment tools and encourage them to use these tools consistently when evaluating their steam systems. DOE Energy Expert Riyaz Papar of Hudson Technologies conducted the assessment. It was successful in identifying some opportunities that enabled complex personnel to improve the steam system's efficiency and significantly reduce the complex's natural gas consumption.

The St. Louis complex's personnel began working to implement several assessment recommendations soon after it was completed. The first project involved optimizing boiler operation and implementing a load management strategy. They then reduced the flue gas oxygen content in one boiler, reduced boiler blowdown, and implemented an ongoing steam trap inspection and repair program. After applying these measures, the complex achieved total annual energy savings of more than 70,000 GJ and annual energy cost savings of around \$627,000. With total implementation costs of \$125,000, the simple payback was just over 2 months. Many other opportunities identified in the assessment are still under consideration, and the assessment methodology has been shared with several other Chrysler plants in the United States.



### 13.2.2. Company & Plant Background

Chrysler LLC produces many kinds of vehicles including passenger automobiles, trucks, minivans, and sport utility and commercial vehicles. Encompassing more than 500,000 m<sup>2</sup>, the St. Louis operation is divided into a north plant and a south plant. The north plant houses 2,300 workers and produces mainly cars and light duty trucks. With 3,200 employees, the south plant turns out Chrysler and Dodge minivans. Both plants receive their utilities (steam, chilled water, and compressed air) from the powerhouse, where four natural gas-fired water-tube boilers produce 10 bar saturated steam. Steam generation varies widely, depending on the season. Steam generation during summer (May to September) is typically 75 Tph; average steam generation in spring, fall, and winter is 25 Tph. During extremely cold weather, steam generation can be as high as 90 Tph. The powerhouse also has three condensing steam turbine-driven chillers and 12 electric motor-driven chillers.

Steam is important for the St. Louis complex's production; it powers steam turbines and provides space and process heating. Because the St. Louis complex uses 2.4 PJ of natural gas and landfill gas per year, energy costs account for a significant amount of the complex's total expenses. The company has set a target of a 2% annual reduction in energy use per unit of production. An employee designated as the "Energy Champion" defines corporate energy reduction goals and helps all the departments in each plant meet them.

### 13.2.3. Near-Term SSO Opportunities

#### 13.2.3.1. Optimize Boiler Operation and Load Management Strategy

The load profile showed that three of the complex's four boilers were typically operated at less than 40% of full load capacity, while the fourth operated at between 50% and 60% of full load during summer months. This resulted in significant part-load losses and excessive energy consumption. The assessment showed that the complex's steam demand could be met by operating fewer boilers at close to full load capacity. Estimated annual energy and cost savings were 22,000 GJ and \$161,000.

#### 13.2.3.2. Raise Boiler Operating Pressure

During summer, three steam condensing turbines drive centrifugal chillers that help meet the complex's cooling load. The assessment team found that the steam turbines' thermal efficiency could be improved if the steam header pressure were raised from the complex's normal operating pressure, 9 bar, to 10 bar in summer. Estimated annual energy savings were 5,400 GJ.

#### 13.2.3.3. Reduce Flue Gas Oxygen Level in Boiler #1

The assessment team found that boiler #1 operated with an excess flue gas oxygen level of approximately 7%. Since the optimal excess oxygen level should have been closer to 3.5%, the excess level resulted in lost heat and greater fuel use. Powerhouse personnel examined the oxygen sensor and the oxygen trim controller and found that the sensor did not function properly. The assessment team estimated that reducing the excess oxygen level to 3.5% could result in annual energy and cost savings of 9,000 GJ and \$68,000.



#### 13.2.3.4. Reduce Boiler Blowdown

The assessment team found that boiler blowdown occurred too often during winter. During summer, when the condensate return was very high, powerhouse personnel managed blowdown well. However, as the weather grew colder and boiler loads declined, proper blowdown cycles were not maintained, especially on partly loaded boilers, resulting in an excessive blowdown rate. The assessment showed that installing new boiler blowdown controllers and improving protocols could reduce that rate. Estimated annual energy savings were approximately 3,000 GJ and \$26,000.

#### 13.2.3.5. Implement Blowdown Heat Recovery

The assessment team found that a heat exchanger was being used to recover heat from the blowdown stream. However, its configuration was causing some steam loss from the blowdown flash to ambient air. The team recommended reconfiguring the system by installing a blowdown flash tank upstream of the heat exchanger to capture steam and send it to the deaerator. The saturated hot water in the flash tank could then exchange heat with make-up water in the heat exchanger. Estimated energy savings were slightly less than 3,000 GJ.

#### 13.2.3.6. Implement a Steam Trap Management Program

The north plant's last steam trap audit was performed almost 10 years ago. Using the SSAT, analysts modeled the impact of a proactive steam trap management program that included annual steam trap testing, regular steam trap database updating, and replacing or repairing defective traps. The model estimated that implementing such a program could achieve annual energy and cost savings of 6,000 GJ and \$50,000.

### **13.2.4. Medium-Term SSO Opportunities**

#### 13.2.4.1. Enhance Feedwater Economizer on Boiler #1

In analyzing operating data, the assessment team noted that the temperature of the exiting flue gas from boiler #1 was about 50°C higher than that from boiler #4 at similar loads and feedwater temperatures, meaning that boiler #1 was using more fuel. The team realized that this might be occurring because boiler #4 was equipped with an enhanced fin-tube economizer, whereas boiler #1 had a plain tube unit, or because the economizer on boiler #1 was fouled. By cleaning or replacing the economizer on boiler #1 with an enhanced fin-tube unit, the complex could save 11,520 GJ annually.

#### 13.2.4.2. Replace Condensing Steam Turbines with Electric Motors

The assessment team found that the three condensing steam turbines that drove chillers provided excess chiller capacity. The turbines were operated at part load during summer under high demand conditions, along with several electrical chillers that were also not fully loaded. The team recommended either replacing the condensing steam turbines with electric motors or shutting one off and splitting the cooling load among the electrical chillers and the other two turbines. This installed capacity would meet the complex's cooling load. Although more electricity would be needed to meet that load, annual natural gas savings could be 135,000 GJ.



### 13.2.5. Results

The St. Louis complex's personnel realized that they could implement some of the recommendations in the assessment right away without affecting production. They began by optimizing boiler operation and starting a steam trap management program. They hired a contractor to train the powerhouse operators on a new boiler operating strategy that enabled them to shut down one boiler and operate the others closer to full load and design conditions. This yielded annual energy and cost savings of more than 48,000 GJ and \$430,000. They then hired another outside expert to perform a steam trap audit in the north plant that found that 30 of the north plant's 48 steam traps had failed. Repairs on those traps were completed in fall 2007, yielding energy and cost savings of just under 10,000 GJ and \$89,000 per year. In addition, steam trap inspections and maintenance are being done more regularly.

Next, complex personnel replaced the oxygen sensor and probe in boiler #1. The oxygen level is now in the proper range, and annual savings of approximately 9,400 GJ and \$84,000 are being witnessed. To reduce boiler blowdown during the winter months, powerhouse personnel changed the blowdown protocols and installed automatic blowdown controllers. Annual energy and cost savings of 3,000 GJ and \$24,000 are resulting from this measure.

The total annual energy savings from the implemented recommendations are more than 70,000 MMBtu. With total implementation costs of \$125,000 and annual energy cost savings of \$627,000, these achievements yield a simple payback of just over 2 months.

Some other recommendations had excessively lengthy payback periods or were too difficult to implement; e.g., replacing the three condensing steam turbines in the powerhouse would require a new main electrical line to the powerhouse and a new substation in addition to various land use issues. The assessment's methodology and the use of the SSAT are being shared with other Chrysler facilities, such as those in Newark, New Jersey and Sterling Heights, Michigan.

## 13.3. Case Study #3 – Terra Nitrogen Company, L.P.

*This Case Study is excerpted from published US DOE literature. The full document is available from the US DOE's website.*

### 13.3.1. Summary

In early 2006, Terra Nitrogen Company, L.P., received a US DOE Save Energy Now assessment at its ammonia and fertilizer plant in Verdigris, Oklahoma, USA. The main objective of the energy assessment was to analyze natural gas use in the plant's steam system and identify opportunities for energy savings. The assessment was performed by DOE Energy Expert Veerasamy Venkatesan of VGAEC, Inc., and it identified some important opportunities for improving the steam system's efficiency. By implementing some of these important opportunities, plant personnel were able to significantly reduce the plant's natural gas consumption.

Verdigris plant personnel wasted no time in implementing several of the assessment's recommendations to improve the efficiency of the plant's steam system. They upgraded two turbines, installed a loop dehydrator on an ammonia plant, and repaired failed steam traps and steam leaks. The aggregate annual energy and cost savings resulting from implementing these measures is approximately 497,000 GJ and more than \$3.5 million. With project costs of around \$3.1 million, the plant achieved a simple payback of less than 11 months. Additional opportunities identified in the energy assessment are still being implemented. The assessment results were shared with three of the parent company's U.S. plants.

### 13.3.2. Company & Plant Background

Terra Nitrogen Company, L.P., an indirect wholly-owned subsidiary of Terra Industries Inc., is a major U.S. producer of nitrogen fertilizer products with annual revenues of more than \$400 million. The company's manufacturing facility in Verdigris, Oklahoma, is a highly integrated manufacturing site producing 2.2 million tons of urea ammonium nitrate solutions and 1.1 million tons of ammonia per year. Terra Nitrogen also operates shipping terminals in Blair, Nebraska, and Pekin, Illinois.

Because natural gas is the primary feedstock for hydrogen (which is combined with nitrogen to make ammonia), the plant requires significant amounts of natural gas for production. In addition, natural gas is the primary fuel for the plant's steam systems, which provide critical support to the ammonia production processes. As a result, natural gas costs account for most of Terra Nitrogen's total expenses, and the Verdigris plant's management is committed to improving its production and steam system efficiency. Natural gas costs for the Verdigris plant were around \$7/GJ during the implementation period.

### 13.3.3. Near-Term SSO Opportunities

#### 13.3.3.1. *Recover Flash Steam from Blowdown Water*

The assessment found that, after flashing to a low-pressure header, a substantial amount of blowdown water was being sent to a cooling tower at 3.5 bar and 150°C. The analysis indicated that routing the blowdown water directly to a deaerator could help generate more than 0.5 Tph of flash steam for the plant. Estimated savings would be 14,982 GJ and \$105,000 per year.

#### 13.3.3.2. *Implement a Steam Trap Maintenance Program*

Although a steam trap audit was not performed during the assessment, the team realized that some steam traps were poorly positioned and some were not even operating. Adopting better trap installation techniques and maintaining the existing steam traps could result in estimated annual energy and cost savings of 12,264 GJ and \$86,000.

#### 13.3.3.3. *Implement a Steam Leak Maintenance Program*

Although few leaks were found, the assessment recommended performing a leak audit and fixing all visible steam leaks. The resulting estimated annual energy and cost savings would be 876 GJ and \$6,000. Project costs were estimated to be \$2,500 to \$4,000.



### 13.3.4. Medium-Term SSO Opportunities

#### 13.3.4.1. Modify Synthesis Loop

The assessment found that the existing synthesis loop in the site's ammonia plant #2 was operating inefficiently, requiring large amounts of high-pressure steam. Reversing the circulation in the ammonia condensing loop would improve the ammonia plant's efficiency and reduce its demand for high-pressure steam. The assessment estimated that this measure would increase the ammonia plant's efficiency by 0.4% and thereby lower high-pressure steam demand by approximately 10 Tph. Energy savings were estimated at 0.4 GJ per ton of output, yielding estimated annual natural gas savings of 274,000 GJ. The resulting annual energy cost savings were estimated to be about \$1.9 million.

#### 13.3.4.2. Turbine Upgrade

Ammonia plant #2 uses two back-pressure turbines to let down 38 bar steam to the 3.5 bar steam used for some low-pressure steam applications. The back-pressure turbines powered methyldiethanolamine pumps and were supplemented by hydraulic turbines. The assessment found that excess 3.5 bar steam was being vented and recommended that the existing turbines be upgraded with more efficient condensing turbines. The recommended condensing turbines could reduce high-pressure steam demand and low-pressure venting, yielding estimated annual energy and cost savings of 178,000 GJ and about \$1.2 million.

#### 13.3.4.3. Improve Operation of Condensing Turbines

The vacuum in the surface condensers of the condensing turbines in ammonia plant #1 is maintained at between 610 mm and 660 mm of Hg, depending on the season. Installing an absorption chiller powered by low-level waste heat that could cool the supply-side cooling tower water could increase the vacuum by an additional 13 mm of Hg. The assessment estimated that this would reduce energy consumption by approximately 170,000 GJ and save approximately \$1.2 million per year.

### 13.3.5. Long-Term SSO Opportunities

#### 13.3.5.1. Build a High-Pressure Natural Gas Pipeline

The energy assessment found that the plant's local utility delivers natural gas to the Verdigris plant at 13 bar. Because the plant requires high-pressure natural gas (38 bar) for its processes, it currently operates steam-driven gas compressors to achieve the required pressure level. The assessment explored the possibility of building a high-pressure gas pipeline from the plant and connecting it to a high-pressure pipeline owned by the plant's natural gas utility. If such a pipeline could be constructed, and the utility would be willing to sell high-pressure natural gas directly to the plant, the plant could save an estimated 851,000 GJ and nearly \$6 million per year.

#### 13.3.5.2. Improve Efficiency of Auxiliary Boiler

The assessment found that the efficiency of the auxiliary boiler in ammonia plant #1 could be improved by reducing the stack temperatures from 204°C to 160°C. This could be done by installing an air preheater on the boiler's stack to recover some of its heat. Estimated annual energy and cost savings are 135,000 GJ and \$945,000.

### 13.3.6. Results

Verdigris plant personnel implemented two of the most important recommendations in the Save Energy Now energy assessment soon after it was conducted and then began working on several others. They upgraded the back-pressure turbines with condensing turbines and installed a loop dehydrator on ammonia plant #2. Both of these measures resulted in annual energy savings of 228,000 GJ, for a combined savings of 456,000 GJ per year. The annual energy cost savings resulting from implementing the two measures is just under \$3.2 million. In addition, the plant hired a consultant to audit and repair broken or poorly functioning steam traps, and it purchased an infrared leak detector to detect and repair steam leaks. Total energy and cost savings from all the implemented measures to date are approximately 497,000 GJ and \$3.5 million. At total implementation costs of just over \$3.1 million, the simple payback is slightly less than 11 months. The Verdigris plant is sharing the results of the assessment and the recommended measures that were implemented with several other Terra Industries facilities.

Verdigris plant personnel carefully reviewed other opportunities uncovered in the assessment and took some other steps to improve steam system efficiency. They examined the boiler in ammonia plant #1 and found that all the boiler's coils were dirty and that one was leaking. They estimated that cleaning and repairing the coils could improve process efficiency by 0.3 GJ/ton. They also evaluated the condensing turbines in ammonia plant #1. Rather than installing an absorption chiller, they decided to overhaul the condensing turbines by changing the rotors, cleaning the cooling units, and replacing the low-pressure steam ejector nozzles during a 2007 plant shutdown for maintenance. Other recommended measures either had lengthy paybacks or were too difficult to implement. For example, many difficult permit and right of way issues were associated with the high-pressure natural gas pipeline, and it would have required renegotiating the plant's contract with its natural gas utility.

## 13.4. Case Study #4 – Del Monte Foods Company

*This Case Study is excerpted from published California Energy Commission (CEC) literature. The full document is available from the CEC Public Interest Energy Research website.*

### 13.4.1. Project Vision

Work with a leading food processor in California, USA such as Del Monte Foods to demonstrate use of the topping cycle to

- use high pressure steam to produce mechanical energy
- use low pressure exhaust steam for process heating

### 13.4.2. Methodology

Thermal processing of fruits and vegetables involves heating the cans in a cooker and then cooling the cans in a cooler. Steam for heating the cans is obtained from gas fired boilers. Chilled water for cooling cans is frequently obtained from electrically driven refrigeration systems. Cooling operation is the bottleneck in the canning process due to heat rejection limitations during summer months when electricity demand is at its peak.



A comprehensive evaluation of energy saving opportunities in the thermal processing operation at Del Monte Plant in Modesto, California, USA was conducted by an energy consultant. Integration of heating and cooling operations using topping cycle concept was selected as the optimal strategy. This involves high-pressure steam turbine driven refrigeration for cooling and low-pressure exhaust steam for heating.

### 13.4.3. Results

The installation at Del Monte plant involves an Elliot Model 2BYRT steam turbine directly coupled to a Bitzer screw chiller. The plant boiler will supply steam to the chiller at 10 bar. The exhaust steam from the turbine at 4 bar is used to heat the retorts. Chiller supplies cold water at 7.2°C for cooling the retorts. Figure 44 provides a photograph of the steam-turbine driven screw chiller.

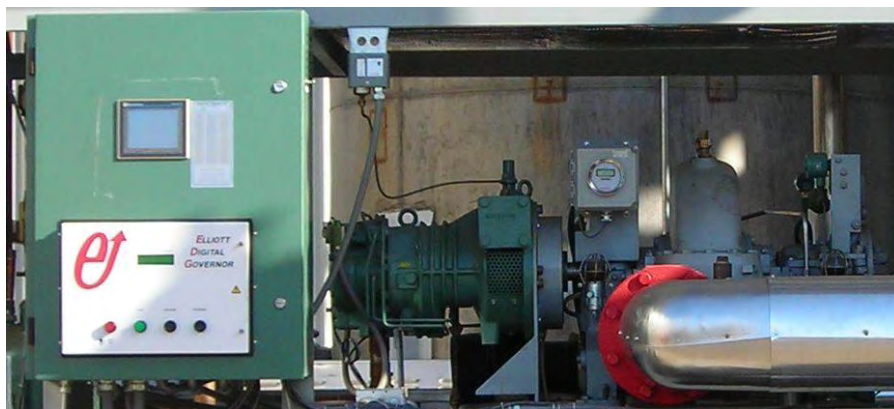


Figure 44: Steam Turbine Driven Screw Chiller

The Elliot steam turbine is rated at 65 kW at 4,000 rpm and the steam flow through the turbine is estimated at 5 Tph. The cost of the steam turbine and controls was about \$30,000. The Bitzer package chiller is rated at 86 tons of refrigeration (302 kW) and cost \$56,000 with controls.

The installation is estimated to reduce the electrical power consumption by 104 kW during the season and 46 kW during the off season. The total electrical energy saving is estimated at 540,000 kWh per year. The natural gas consumption was expected to increase by 2,000 GJ due to additional steam generation to offset the enthalpy change through the steam turbine. The net annual savings by the installation is estimated at \$45,000.

## 13.5. Case Study #5 – Recover Condensate from Evaporator Paste Sterilizers

### 13.5.1. Original System

The Evaporator Paste Sterilizers are heated with direct steam injected hot-water at 95°C. The excess hot water is drained to grade and the flash vented to atmosphere. Figure 45 presents a picture of the original sterilizer operations. Note the “Red Oval” depicting the hot water drained to grade and ambient. To understand the process from a system perspective, Figure 6 presents a schematic of the process flow diagram.

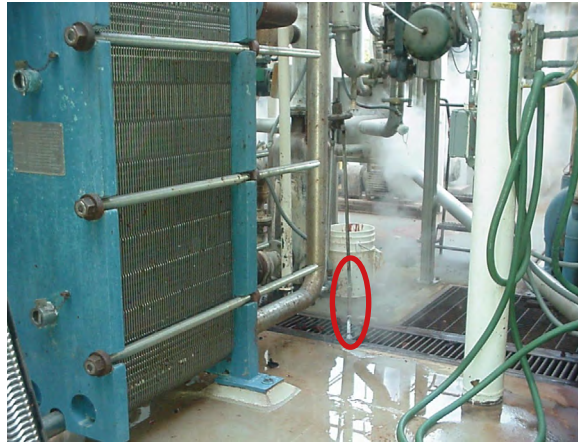


Figure 45: Evaporator Paste Sterilizer

### 13.5.2. Improved System Configuration

The system in Figures 45 and 46 which had a direct steam injection heater was replaced with a shell and tube heat exchanger. The heating loop now contains the exact amount of water required for performing closed-loop operations. Steam flow is regulated based on the required hot water temperature supplied from this steam/ hot water exchanger. All the condensate from this new heat exchanger is returned using a condensate receiver & pump-trap. Figure 47 presents a schematic of the new process flow diagram.

#### Existing direct contact APV sterilizers

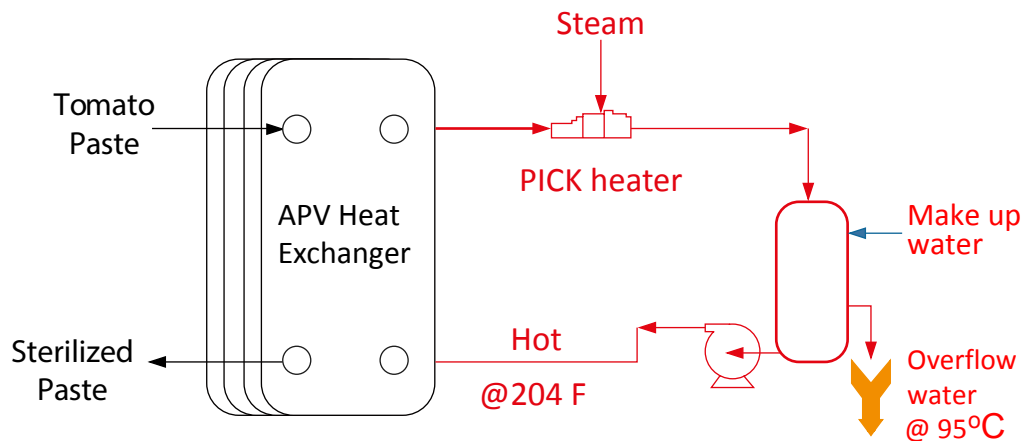


Figure 46: Process Flow Schematic of Original Evaporator Paste Sterilizer System

### 13.5.3. Results

The reconfiguration of the process and recovering condensate from the evaporator paste sterilizers resulted in annual energy savings of  $\sim 30,200$  GJ. This translated directly to annual cost savings of  $\sim \$151,000$ . The tomato plant processing operations are seasonal (and not year round), the system has only 2,400 hours of full load and 1,200 hours of 50% load annually. Nevertheless, the payback for this project was  $\sim 8$  months.

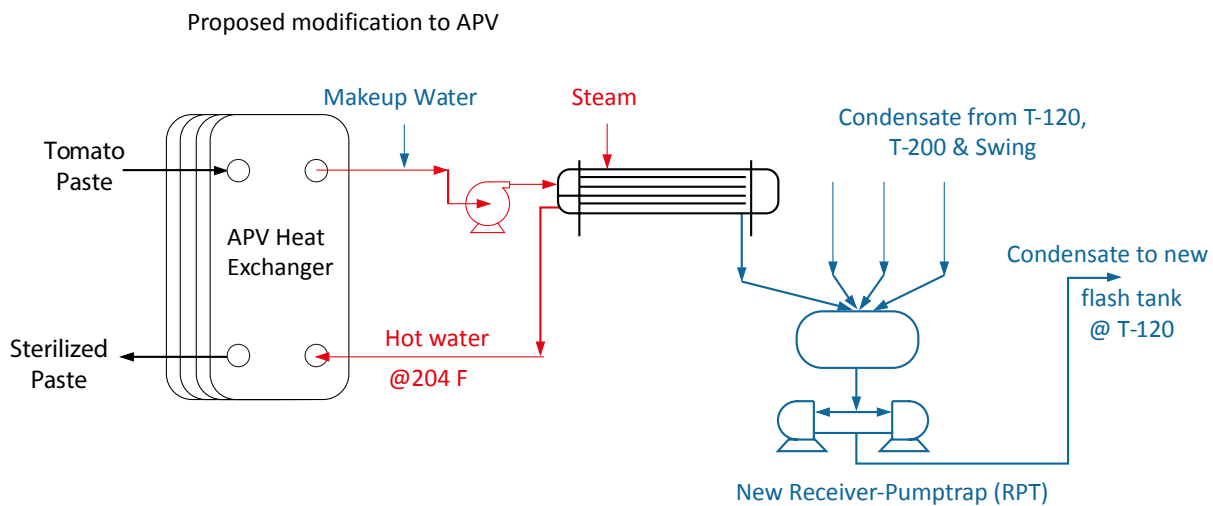


Figure 47: Process Flow Schematic of Improved Evaporator Paste Sterilizer System

## 13.6. Case Study #6 – Steam/Electric Drive Optimization in a Refinery

### 13.6.1. Original System

In 1996, a steam system energy assessment was conducted in a petroleum refinery in the United Kingdom. A refinery has one of the most complex steam generation and distribution systems due to usages at multiple header levels and optimizing these steam systems is a dynamic challenge. During this refinery energy audit it was found that:

- Steam letdown using a pressure reducing station from high-pressure to medium-pressure was *~18,850 tonnes/yr*
- Steam letdown using a pressure reducing station from medium-pressure to low-pressure was *~110,368 tonnes/yr*
- Steam venting from the low-pressure was *~11,108 tonnes/yr*

The above steam (un)balance and operations at the refinery clearly indicated that plant personnel were not able to manage the steam-turbine/electric motor drives in an optimized configuration. More importantly, as the refinery throughput changed and product mix varied based on seasonality, it was difficult to optimize the operations. Hence, it was decided to develop a steam turbine/electric motor drive optimization strategy based on different load and operating conditions at the refinery.

During the energy assessment it was found that there were several types of rotating equipment that had both steam turbine drives and electric motor drives. Some of the rotating equipment had both the drives on the same shaft while some had just multiple units with different drive configurations. Figure 48 provides a schematic of the refinery overall steam system to illustrate the overall configuration.



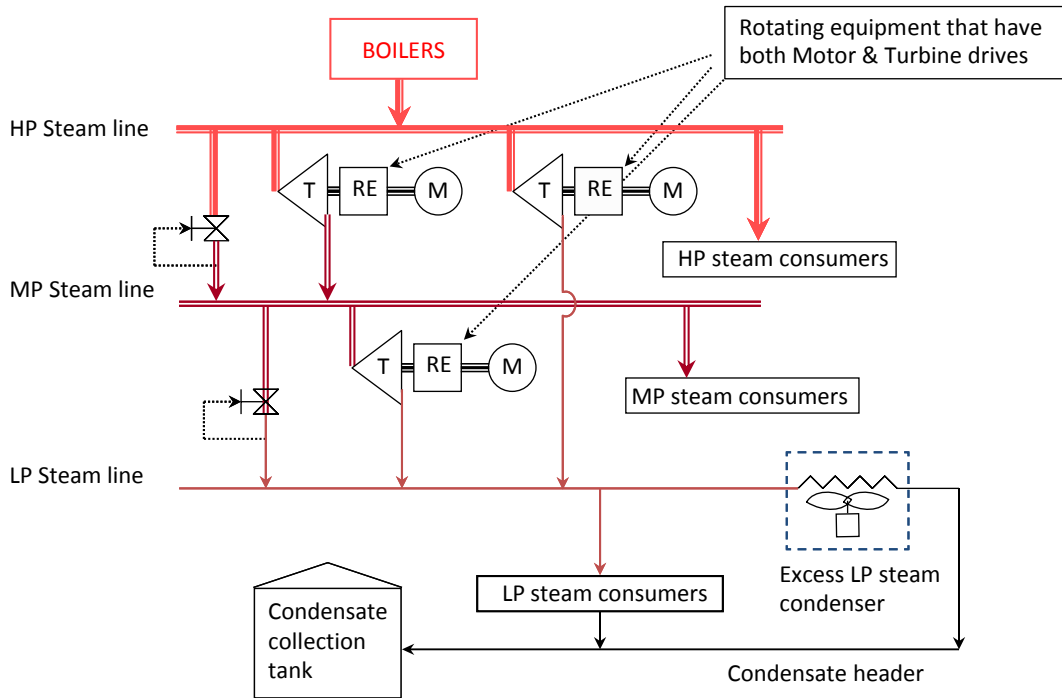


Figure 48: Steam System Balance Diagram at the Refinery

### 13.6.2. System Optimization Evaluation

Table 16 presents a comprehensive list of all the steam turbine drives in the refinery. Additionally, it categorizes them based on steam inlet conditions and provides information on inlet steam required ( $T_{ph}$ ) for normal operation of the turbine. All these turbines drive rotating equipment and hence, should be treated as fixed steam flow devices since the shaft power required is fixed by the process and not by steam demand on the header.

Steam systems optimization analysis allowed for calculation of the true impact costs of operating each of these turbines based on whether the low-pressure exhaust steam from the turbine was used for process heat at the low-pressure header or if it was vented to ambient. Each of these operating costs was then compared to impact electrical costs to make an optimal decision of operating turbine-drives or the electrical motor. To illustrate this example and methodology further consider the Ethane Refrigeration Compressor (ERC). The operating cost of the ERC using the steam-turbine when low-pressure exhaust steam is vented is calculated to be  $\sim \$84.84/hr$ . If the low-pressure exhaust steam was instead used to supply heat to a process, the ERC operating cost would be  $\sim \$12.6/hr$ . Alternately, if the steam turbine drive was shut down and the ERC was operated with an electric motor, the operating cost would be  $\$46.2/hr$ . So clearly, if steam is used by downstream process it is the most cost-effective and optimal strategy and as soon as steam has to be vented at low-pressure, certain steam-turbine drives need to be switched over to corresponding electric motor drives. This quantified impact is presented in Figure 49.

### 13.6.3. Results

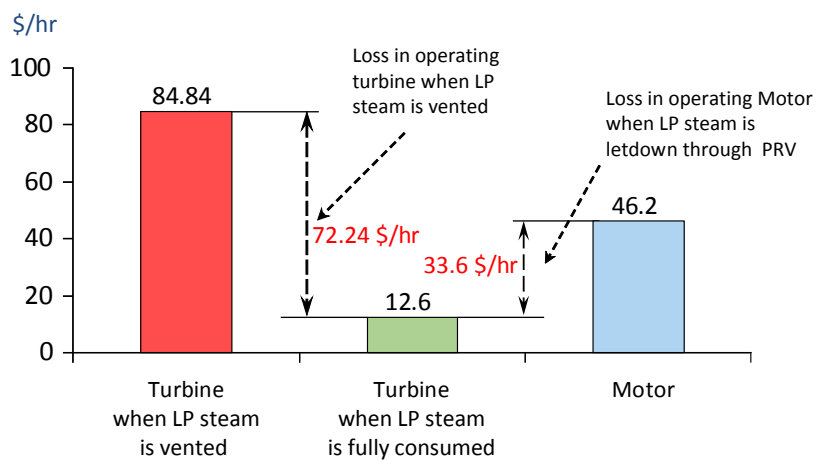
The steam turbine/electric motor drive optimization evaluation and load management strategy concluded that the ethane refrigerant compressor turbines, air compressor turbines,



stabilizer reboiler turbines, ethane compressor seal oil turbine and treated water pump turbines could be switched over from steam turbine to electric motor driven operations as the steam demand on the medium and low pressure header dropped due to reduced operating throughput rates in the refinery. This optimization and load management strategy saved the refinery ~\$30,000 annually without incurring any implementation costs.

**Table 16: Steam Turbine Drives on Rotating Equipment in UK Refinery**

	Total available Turbines	Turbines normally in service	Normal steam consumption	
			in lb/hr	T/hr per turbine
<b>HP steam turbines</b>				
C2 refrig. compressor turbines	3	2	23830	11.91
Air compressor turbines	2	1	7207	7.21
Boiler feed pump turbines	3	3	16847	5.62
Stabilizer reboiler turbines	14	12	64924	5.41
Stabilizer inter-heater pumps #1-4	4	4	15480	3.87
Cooling water pump turbine (MP)	2	2	16757	8.38
Stabilizer inter-heater pumps #5-7 (MP)	3	2	18257	9.13
Stabilizer O.H. compressor turbine (C)	2	2	31932	15.97
<b>MP steam turbines</b>				
Condensate to Deaerator pumps	2	2	3243	1.62
C3 vaporizer Glycol pump	1	1	1340	1.34
C2 stablg. compr. sealoil turbine	3	2	2532	1.27
Stab. OH compr. lubeoil	2	2	2216	1.11
Treated water pumps	2	1	1025	1.02
Stab. OH compr. sealoil pumps	3	2	1847	0.92
C3 refrig. compr. aux. turbine	3	2	1712	0.86



**Figure 49: Operating Cost Impact & Optimization for ERC at the Refinery**

### 13.7. Case Study #7 – Better utilization of Steam’s superheat

In a commodity chemical plant in Europe, two steam turbines drove a large air compressor and an electric generator in a single-shaft arrangement. The first turbine, a backpressure turbine, was used to let down high-pressure (HP) steam at 930 psig to medium-pressure (MP) steam at 290 psig. The second turbine, an extraction-condensing turbine, receives MP steam, which is extracted as low-pressure (LP) steam at 73 psig (in the extraction section) for process use, and the remaining MP steam is expanded into a vacuum condenser (Figure 50).

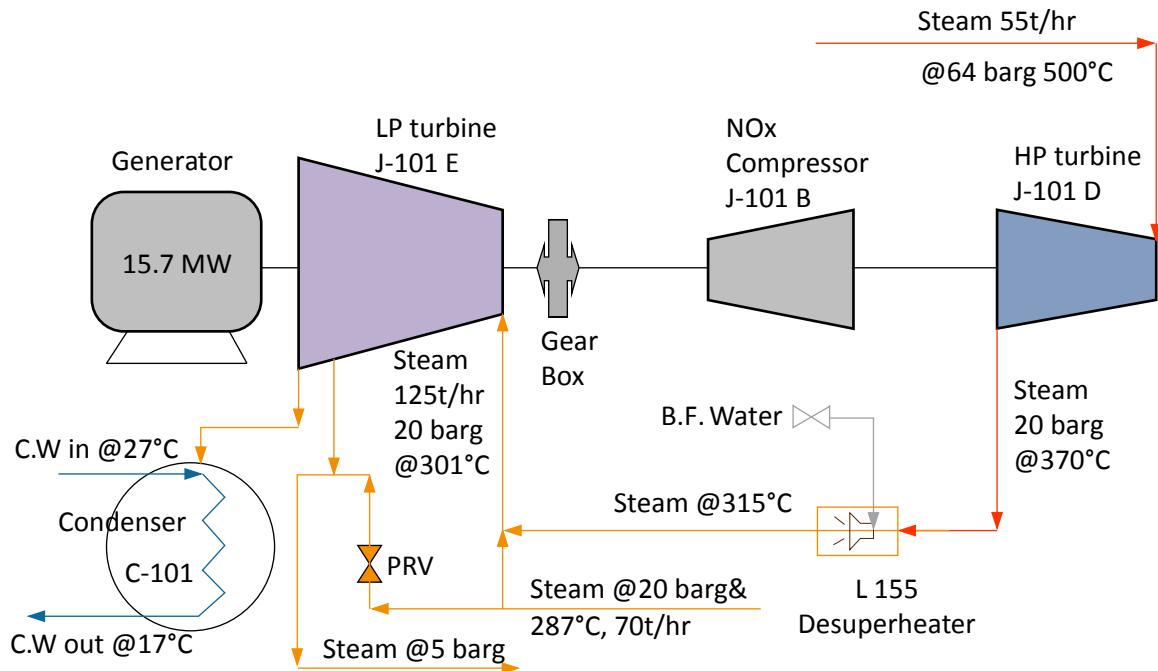


Figure 50: Observed Turbine Operation at the Plant

In the original design, only the exhaust steam from the backpressure turbine was used to supply MP steam to the extraction-condensing turbine. Because the temperature of the outlet steam from the backpressure turbine was higher than 660°F (the maximum allowable steam inlet temperature specified for the extraction-condensing turbine), before entering the turbine, the MP steam went through a desuperheater to reduce its temperature. In this design, the desuperheater was designed to produce MP steam at 600°F — providing for a 60°F safety margin. (Note that the amount of work extracted from a steam turbine decreases as the inlet temperature goes down, so adding the desuperheater reduced the amount of work generated by the extraction-condensing turbine.)

The original design was later modified to add steam from a waste-heat boiler (WHB) to the steam from the backpressure turbine outlet, which increased the steam flow to the extraction-condensing turbine and thus raised its power output. The temperature of the steam from the WHB was 550°F — significantly cooler than the exhaust steam from the backpressure turbine. When they made this modification, the designers did not re-evaluate the use of the desuperheater.



During an Energy Optimization study of this system the consultant found that the maximum temperature that can be reached with the combined steam flow to the extraction-condensing turbine is below 660°F and desuperheating of the backpressure turbine exhaust steam can be safely eliminated. Based on this finding, a bypass line was installed around the desuperheater, and the water supply to the desuperheater was shut off (Figure 51). This change increased the amount of electricity generated by the turbine by 500 kW, resulting in an annual energy cost saving of \$400,000.

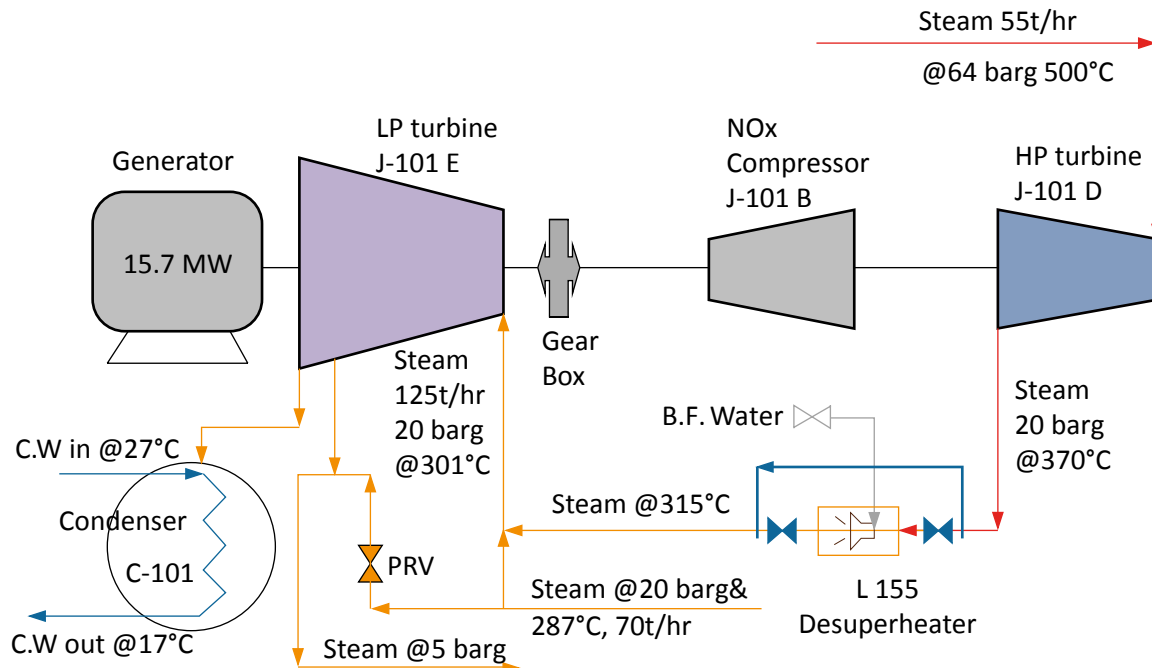


Figure 51: Turbine Operation modified without Desuperheater

This example illustrates the need to challenge existing operating practices, and also to re-evaluate conditions when process changes are made. While it is always essential to operate within design limits, excessively large margins of safety can result in unnecessary losses of energy efficiency.

### 13.8. Case Study #8 – Waste Heat Utilization and Heat Integration

Typically preheating the make-up feedwater at a deaerator can consume 10%, or even 15%, of the total steam generated on a site. For this reason, make-up water is often considered as a good heat sink for heat integration with recovered waste process heat.

In this example, the deaerator in a chemical plant processed a combination of warm returned condensate and softened makeup water that is available only at ambient temperature. Within the boiler house there were also several water-cooled air compressors (Figure 52), one of which was experiencing chronic maintenance problems in its cooling tower.

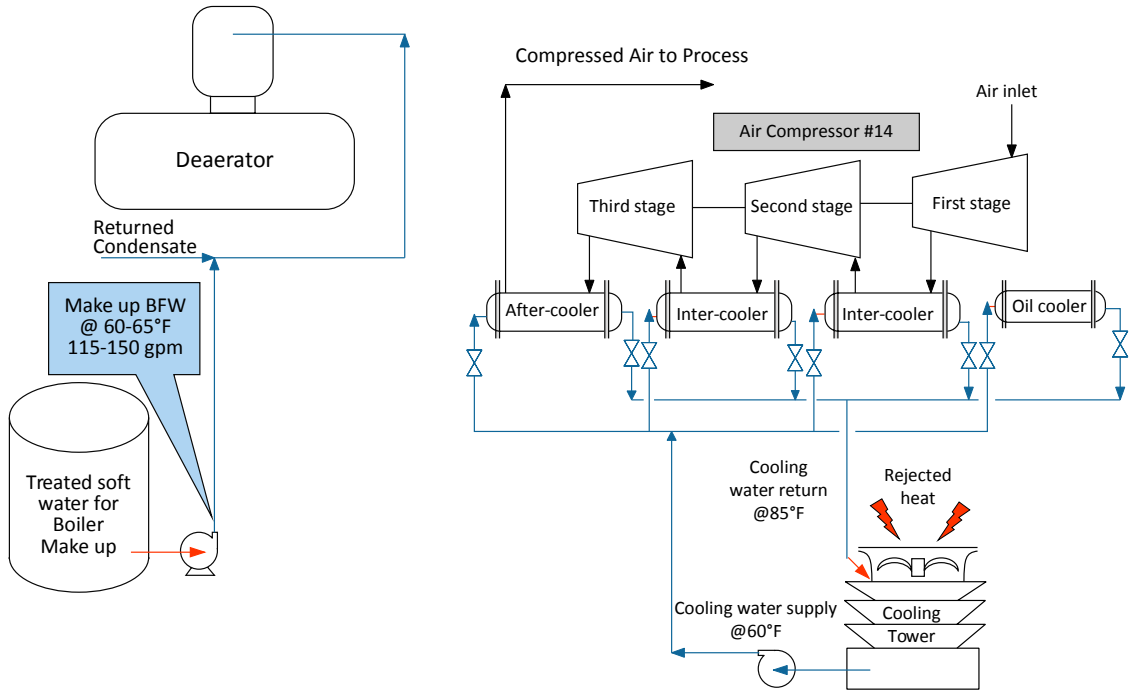


Figure 52: Heat Rejection at Cooling Tower and Heat addition at Deaerator

During a project to replace this cooling tower, the Energy Consultant noticed that the average quantity of softened makeup water at ambient temperature going to the deaerator (115–150 gpm) was almost identical to the amount of cooling water needed for the air compressor (120 gpm). Based on this observation, a new project was proposed to route the makeup water through the air compressor and isolate the cooling tower with blinds (Figure 53). The new proposal was evaluated and accepted, and the piping modifications were completed within two months.

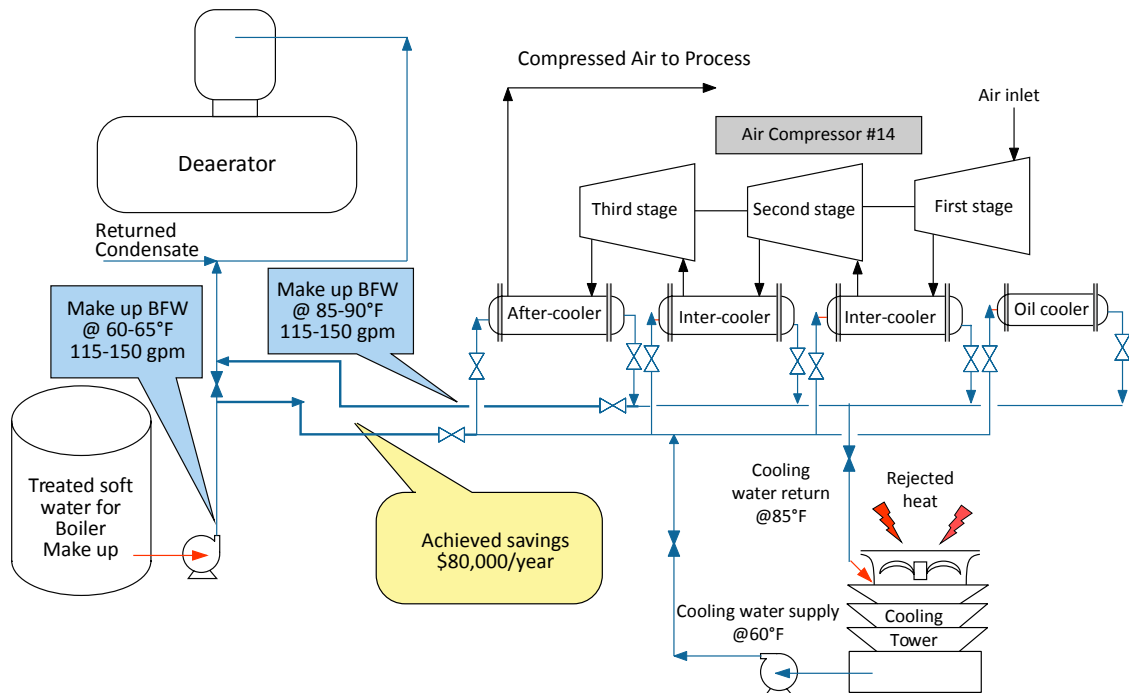
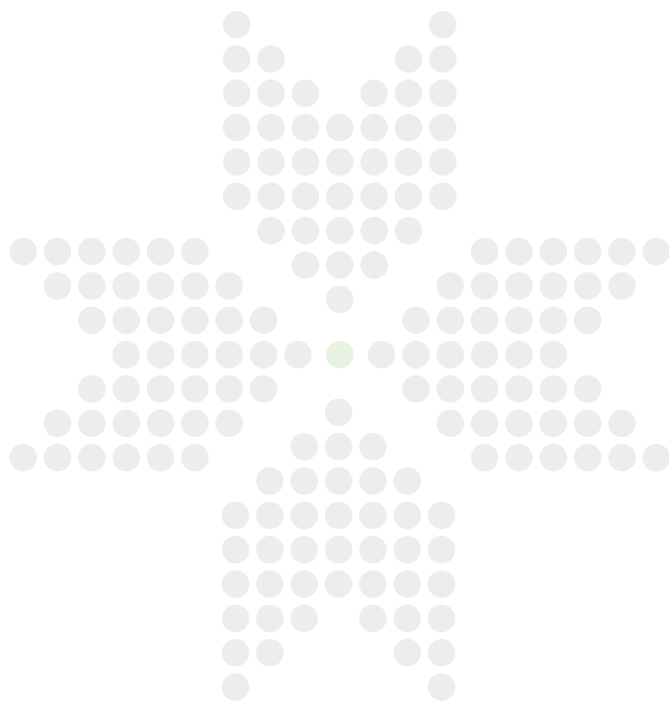


Figure 53: Heat Integration by recovering the rejected heat at the Cooling Tower



Heat from the air compressor is now recovered by preheating the softened water, saving \$80,000/yr in deaerator steam usage. Implementation was inexpensive, as it required only local piping changes. In addition, the project removed the need to maintain or replace the cooling tower, thus eliminating a significant cost.

This example illustrates the importance of looking for creative ways to redeploy existing equipment *in situ* to save energy.



## 14. CONCLUSIONS & NEXT STEPS

---

It is expected that this Expert Steam Systems Optimization Training Manual has provided the reader with insights as to the overall steam systems optimization investigation methodology when working with an industrial steam system. Additionally, it is expected that the reader will have gained a tremendous insight into field work using portable instrumentation, preparation of the steam systems optimization report and project implementations from the different case studies presented. There are several optimization opportunities and BestPractices that can be implemented to minimize operating costs, improve overall system operations and reduce GHG emissions. All these areas were discussed in detail in the Experts Training Manual and are summarized again in the sections below.

### 14.1. Steam Systems Optimization Opportunities & BestPractices

This section summarizes all the steam system opportunities and BestPractices identified in an industrial plant. This section should also serve as a checklist for steam system energy experts and steam system users to ensure that their steam systems are operating at their optimized configurations. Although there could be many objectives for optimizing the steam system, the main objective for this Experts Training Manual was to minimize operating costs.

#### 14.1.1. Steam Generation Area Optimization Opportunities & BestPractices

There are several optimization opportunities and bestpractices in the steam generation area, including:

- Minimize excess air
- Install heat recovery equipment
- Clean boiler heat transfer surfaces
- Improve water treatment
- Install an automatic boiler blowdown controller
- Recover energy from boiler blowdown
- Add/restore boiler refractory
- Minimize the number of operating boilers
- Investigate fuel switching
- Optimize deaerator operations



### 14.1.2. Steam Distribution Area Optimization Opportunities & BestPractices

There are several optimization opportunities and bestpractices in the steam distribution area including:

- Repair steam leaks
- Minimize vented steam
- Ensure that steam system piping, valves, fittings and vessels are well insulated
- Isolate steam from unused lines
- Minimize flows through pressure reducing stations
- Reduce pressure drop in headers
- Drain condensate from steam headers

### 14.1.3. Steam End-Use Area Optimization Opportunities & BestPractices

It is extremely difficult to cover end-uses that are specific to industrial processes and plants. Process and utility integration leads to overall energy system optimization of the plant and the benefits are far-reaching. In the classic configuration, the main strategies to optimize steam in the end use area are:

- Eliminate or reduce the amount of steam used by a process
- Improve process efficiency and eliminate inappropriate steam usage
- Use steam at as low a pressure as possible which would possibly allow power generation
- Shift all or part of the steam demand to a waste heat source
- Upgrade low pressure (or waste) steam to supply process demands that would have otherwise used much higher pressure steam.

### 14.1.4. Condensate Recovery Area Optimization Opportunities & BestPractices

There are several optimization opportunities and bestpractices in the condensate recovery area including:

- Implement an effective steam-trap management and maintenance program
- Recover as much as possible of available condensate
- Recover condensate at the highest possible thermal energy
- Flash high pressure condensate to make low pressure steam

### 14.1.5. Combined Heat and Power Area Optimization Opportunities & BestPractices

The CHP optimization opportunity in industrial steam systems almost always relies on understanding the economic benefit of modifying operations of steam turbines. In industrial CHP applications, two major turbine configurations are encountered and they include:

- Backpressure
- Condensing





## 14.2. Steam System Assessment Standard

It is important for a system-specific energy assessment to follow a protocol that sets the expectations of the industry and deliverables from the energy experts (consultants). The Experts Training Manual relies heavily on the standard - Energy Assessment for Steam Systems (ASME EA-3-2009). It is expected that steam system energy experts and consultants should have a copy of the standard. This chapter is provided here in the Experts Training Manual to provide an overview of the assessment protocol and highlight some of the salient features.

The ASME Standard (ASME EA-3-2009) – Energy Assessment for Steam Systems is a non-prescriptive standard that clearly identifies processes, protocols and deliverables of a steam assessment. In addition to the ASME Standard, there is an accompanying guidance document (ASME EA-3G-2010 – Guidance for ASME EA-3, Energy Assessment for Steam Systems) that further helps the Steam System Expert properly apply the Standard during an energy assessment.

It is expected that the use of this ASME Standard and the accompanying Guidance Document will increase the quantity and quality of energy assessments performed, with significant potential savings in implemented energy costs and steam systems optimization. The Standard and the Guidance Document are intended for energy managers, facility managers, plant engineers, energy consultants, maintenance managers, plant managers and EH&S managers, across a broad range of industries.

## 14.3. Data Collection & Portable Instrumentation

An industrial steam system energy assessment will require a significant amount of data collection. Data can be in several different formats and will depend on the specific industrial plant, steam system being evaluated, scope of the assessment and the actual steam systems optimization projects being evaluated for the industrial steam system. In general, the data collection strategy focuses on two areas of data collection:

- Design information
- Operating data

In industrial steam systems, operating data measurements of process and utility variables typically consist of:

- Temperature
- Pressure
- Flow
- Combustion analysis
- Energy usage
- Water chemistry
- Power production

Most industrial plants' utility systems, such as steam, do not have enough instrumentation to undertake a detailed mass and energy balance on the system. This makes it very difficult to analyze industrial steam systems and understand operating conditions and identify steam systems optimization opportunities. Portable (hand-held) instrumentation should be used whenever possible during an industrial steam system assessment to capture operating data instantaneously and be able to use the information for steam systems optimization opportunities. Sometimes portable instrumentation provides an excellent check on the in-situ instrumentation.



Lastly, there may be multiple instruments available and/or required for measuring a certain process or utility variable. It is very important that the steam system energy expert understand the functionalities and capabilities of portable instrumentation and have access to them when undertaking a steam system energy assessment in an industrial plant.

#### 14.4. Steam System Assessment Report

It is expected that after the completion of an industrial steam system assessment, the steam system expert will present a report to the industrial plant personnel. This report can take several forms but at a minimum there should be a wrap-up meeting at the end of the assessment in the plant. This should then be followed up by a detailed Steam System Assessment Summary Report. It is imperative that the steam system expert present this final report to plant personnel within a reasonable time frame (such as within 3-4 weeks after completing the assessment).

The expert should make every effort to ensure that the wrap-up meeting at the end of the steam system energy assessment is face-to-face with plant personnel and is attended by plant management, decision makers for the implementation of projects and all the plant personnel who participated in the energy assessment site work. The wrap-up meeting should be used to get buy-in from everyone present on the list of the improvement opportunities that were identified during the assessment. The best way to organize this wrap-up meeting is to schedule it prior to the start of the assessment and invite all the people who should be involved in this meeting.

The steam system assessment final report is the document which sets down everything about the assessment and the results. There is no set format or template for the assessment final report but it is expected that it be comprehensive enough for the plant personnel to understand the data captured, analysis conducted and the quantification of the identified potential optimization opportunities. Additionally, the report should have qualitative recommendations or opportunities that were identified but need additional due-diligence before quantifying their benefits. The general sections of a typical steam system assessment report (as prepared for US Department of Energy steam system assessments) with a brief description and example (wherever possible) are presented in Chapter 12. This report format can be followed by steam system experts and may be standardized for their use going forward.

#### 14.5. Next Steps

It is anticipated that after completing the Experts Training on Steam Systems Optimization, attendees would be able to use the different tools and resources to undertake detailed steam system assessments and follow them up with project implementation.

Steam system experts should engage with industrial plants and develop action plans for assessing their steam systems. They should start with a simple scoping and information gathering tool that allows them to understand the industrial steam system and to identify all the BestPractices currently implemented in the industrial steam system.

Steam system experts should work with industrial plants to conduct detailed (investment-grade) energy assessments to identify areas of optimization opportunities. This should be followed by the steam system assessment report which clearly quantifies each of the steam systems optimization opportunities and their projected implementation costs. This report should be used by the industrial plant to implement projects for steam systems optimization.

## 15. REFERENCES

---

1. US Department of Energy Industrial Technologies Program – Steam BestPractices Software Tools Suite - <http://www1.eere.energy.gov/industry/bestpractices/software.html>
2. US Department of Energy Industrial Technologies Program – Steam BestPractices Publications - <http://www1.eere.energy.gov/industry/bestpractices/publications.asp>
3. Harrell, Greg, *Steam System Survey Guide*, ORNL/TM-2001/263, May 2002.
4. US Department of Energy’s Industrial Technologies Program, *Improving Steam System Performance – A Sourcebook for Industry*, September 2010.
5. The American Society of Mechanical Engineers, *Fired Steam Generators – Performance Test Codes*, ASME PTC-4, 2008.
6. The American Society of Mechanical Engineers, *Energy Assessment for Steam Systems*, ASME EA-3-2009.
7. The American Society of Mechanical Engineers, *Guidance for ASME EA-3, Energy Assessment for Steam Systems*, ASME EA-3G-2010.
8. Heinz, B. and Singh, M., *Steam Turbines – Design, Applications and Rerating*, 2<sup>nd</sup> Edition, McGraw Hill, 2009.
9. Flynn, D., *The NALCO Water Handbook*, 2<sup>nd</sup> Edition, 2009.
10. Avallone, E., Baumeister, T. and Sadegh, A., *Marks’ Standard Handbook for Mechanical Engineers*, 11<sup>th</sup> Edition, 2006.
11. Green, D. and Perry, R., *Perry’s Chemical Engineers’ Handbook*, 8<sup>th</sup> Edition, 2007.
12. Kenneth, O., *Industrial Boiler Management: An Operator’s Guide*.
13. Moran, M. and Shapiro, H., *Fundamentals of Engineering Thermodynamics*, 6<sup>th</sup> Edition, John Wiley & Sons, Inc., 2008.
14. Lemmon E. W., Huber M. L. and McLinden M. O., *REFPROP*, NIST Standard Reference Database 23, version 9.0, 2010.





# APPENDIX A: STEAM TABLES (FROM REFPROP)

## A.1 Saturated Liquid and Vapor Properties (by Pressure)

Temperature °C	Absolute pressure bar	Liquid density kg/m <sup>3</sup>	Vapor density kg/m <sup>3</sup>	Liquid Enthalpy kJ/kg	Vapor Enthalpy kJ/kg	Liquid Entropy kJ/kg-K	Vapor Entropy kJ/kg-K
81,32	0,50	970,940	0,309	340,54	2645,20	1,0912	7,5930
99,61	1,00	958,630	0,590	417,50	2674,90	1,3028	7,3588
111,35	1,50	949,920	0,863	467,13	2693,10	1,4337	7,2230
120,21	2,00	942,940	1,129	504,70	2706,20	1,5302	7,1269
127,41	2,50	937,020	1,392	535,34	2716,50	1,6072	7,0524
133,52	3,00	931,820	1,651	561,43	2724,90	1,6717	6,9916
138,86	3,50	927,150	1,908	584,26	2732,00	1,7274	6,9401
143,61	4,00	922,890	2,163	604,65	2738,10	1,7765	6,8955
147,90	4,50	918,960	2,416	623,14	2743,40	1,8205	6,8560
151,83	5,00	915,290	2,668	640,09	2748,10	1,8604	6,8207
155,46	5,50	911,850	2,919	655,76	2752,30	1,8970	6,7886
158,83	6,00	908,590	3,169	670,38	2756,10	1,9308	6,7592
161,98	6,50	905,510	3,418	684,08	2759,60	1,9623	6,7322
164,95	7,00	902,560	3,666	697,00	2762,80	1,9918	6,7071
167,75	7,50	899,740	3,914	709,24	2765,60	2,0195	6,6836
170,41	8,00	897,040	4,161	720,86	2768,30	2,0457	6,6616
172,94	8,50	894,430	4,407	731,95	2770,80	2,0705	6,6409
175,35	9,00	891,920	4,654	742,56	2773,00	2,0940	6,6213
177,66	9,50	889,480	4,900	752,74	2775,10	2,1165	6,6027
179,88	10,00	887,130	5,145	762,52	2777,10	2,1381	6,5850
182,01	10,50	884,840	5,390	771,94	2778,90	2,1587	6,5681
184,06	11,00	882,620	5,635	781,03	2780,60	2,1785	6,5520
186,04	11,50	880,460	5,880	789,82	2782,20	2,1976	6,5365
187,96	12,00	878,350	6,125	798,33	2783,70	2,2159	6,5217
189,81	12,50	876,290	6,370	806,58	2785,10	2,2337	6,5074
191,60	13,00	874,280	6,614	814,60	2786,50	2,2508	6,4936
193,35	13,50	872,310	6,859	822,39	2787,70	2,2674	6,4803
195,04	14,00	870,390	7,103	829,97	2788,80	2,2835	6,4675
196,69	14,50	868,500	7,348	837,35	2789,90	2,2992	6,4550
198,29	15,00	866,650	7,592	844,56	2791,00	2,3143	6,4430
199,85	15,50	864,840	7,837	851,59	2791,90	2,3291	6,4313
201,37	16,00	863,050	8,082	858,46	2792,80	2,3435	6,4199
202,86	16,50	861,300	8,326	865,17	2793,70	2,3575	6,4089
204,31	17,00	859,580	8,571	871,74	2794,50	2,3711	6,3981
205,73	17,50	857,890	8,816	878,17	2795,20	2,3845	6,3877
207,11	18,00	856,220	9,061	884,47	2795,90	2,3975	6,3775

Temperature °C	Absolute pressure bar	Liquid density kg/m <sup>3</sup>	Vapor density kg/m <sup>3</sup>	Liquid Enthalpy kJ/kg	Vapor Enthalpy kJ/kg	Liquid Entropy kJ/kg-K	Vapor Entropy kJ/kg-K
208,47	18,50	854,580	9,306	890,65	2796,60	2,4102	6,3675
209,80	19,00	852,960	9,551	896,71	2797,20	2,4227	6,3578
211,10	19,50	851,370	9,796	902,66	2797,80	2,4348	6,3483
212,38	20,00	849,800	10,042	908,50	2798,30	2,4468	6,3390
213,63	20,50	848,250	10,287	914,24	2798,80	2,4584	6,3299
214,86	21,00	846,720	10,533	919,87	2799,30	2,4699	6,3210
216,06	21,50	845,210	10,779	925,42	2799,70	2,4811	6,3123
217,25	22,00	843,720	11,026	930,87	2800,10	2,4921	6,3038
218,41	22,50	842,240	11,272	936,24	2800,50	2,5029	6,2954
219,56	23,00	840,790	11,519	941,53	2800,80	2,5136	6,2872
220,68	23,50	839,350	11,766	946,74	2801,10	2,5240	6,2791
221,79	24,00	837,920	12,013	951,87	2801,40	2,5343	6,2712
222,88	24,50	836,510	12,260	956,92	2801,70	2,5443	6,2634
223,95	25,00	835,120	12,508	961,91	2801,90	2,5543	6,2558
225,01	25,50	833,740	12,756	966,82	2802,10	2,5640	6,2483
226,05	26,00	832,370	13,004	971,67	2802,30	2,5736	6,2409
227,07	26,50	831,020	13,253	976,46	2802,50	2,5831	6,2336
228,08	27,00	829,680	13,501	981,18	2802,70	2,5924	6,2264
229,08	27,50	828,360	13,750	985,85	2802,80	2,6016	6,2194
230,06	28,00	827,040	14,000	990,46	2802,90	2,6106	6,2124
231,02	28,50	825,740	14,250	995,01	2803,00	2,6195	6,2056
231,98	29,00	824,450	14,500	999,51	2803,10	2,6283	6,1988
232,92	29,50	823,170	14,750	1004,00	2803,10	2,6370	6,1921
233,85	30,00	821,900	15,001	1008,30	2803,20	2,6455	6,1856
234,77	30,50	820,640	15,251	1012,70	2803,20	2,6540	6,1791
235,68	31,00	819,390	15,503	1017,00	2803,20	2,6623	6,1727
236,57	31,50	818,150	15,754	1021,20	2803,20	2,6706	6,1664
237,46	32,00	816,920	16,006	1025,40	2803,10	2,6787	6,1602
238,33	32,50	815,710	16,259	1029,60	2803,10	2,6867	6,1540
239,20	33,00	814,490	16,512	1033,70	2803,00	2,6946	6,1479
240,05	33,50	813,290	16,765	1037,80	2803,00	2,7025	6,1419
240,90	34,00	812,100	17,018	1041,80	2802,90	2,7102	6,1360
241,73	34,50	810,910	17,272	1045,80	2802,80	2,7178	6,1301
242,56	35,00	809,740	17,526	1049,80	2802,60	2,7254	6,1243
243,37	35,50	808,570	17,781	1053,70	2802,50	2,7329	6,1186
244,18	36,00	807,410	18,036	1057,60	2802,40	2,7403	6,1129
244,98	36,50	806,250	18,291	1061,50	2802,20	2,7476	6,1073
245,77	37,00	805,100	18,547	1065,30	2802,10	2,7549	6,1018
246,56	37,50	803,960	18,803	1069,10	2801,90	2,7620	6,0963
247,33	38,00	802,830	19,059	1072,80	2801,70	2,7691	6,0908
248,10	38,50	801,710	19,316	1076,50	2801,50	2,7761	6,0854



Temperature °C	Absolute pressure bar	Liquid density kg/m <sup>3</sup>	Vapor density kg/m <sup>3</sup>	Liquid Enthalpy kJ/kg	Vapor Enthalpy kJ/kg	Liquid Entropy kJ/kg-K	Vapor Entropy kJ/kg-K
248,86	39,00	800,590	19,574	1080,20	2801,30	2,7831	6,0801
249,61	39,50	799,470	19,832	1083,90	2801,10	2,7900	6,0748
250,35	40,00	798,370	20,090	1087,50	2800,80	2,7968	6,0696
251,09	40,50	797,270	20,349	1091,10	2800,60	2,8035	6,0644
251,82	41,00	796,170	20,608	1094,70	2800,30	2,8102	6,0592
252,55	41,50	795,080	20,867	1098,20	2800,10	2,8168	6,0542
253,26	42,00	794,000	21,127	1101,70	2799,80	2,8234	6,0491
253,98	42,50	792,930	21,388	1105,20	2799,50	2,8299	6,0441
254,68	43,00	791,850	21,649	1108,70	2799,20	2,8363	6,0391
255,38	43,50	790,790	21,910	1112,10	2798,90	2,8427	6,0342
256,07	44,00	789,730	22,172	1115,50	2798,60	2,8490	6,0293
256,76	44,50	788,670	22,434	1118,90	2798,30	2,8553	6,0245
257,44	45,00	787,620	22,697	1122,20	2797,90	2,8615	6,0197
258,11	45,50	786,570	22,960	1125,60	2797,60	2,8677	6,0150
258,78	46,00	785,530	23,224	1128,90	2797,30	2,8738	6,0102
259,44	46,50	784,500	23,488	1132,20	2796,90	2,8799	6,0055
260,10	47,00	783,470	23,753	1135,50	2796,50	2,8859	6,0009
260,75	47,50	782,440	24,018	1138,70	2796,20	2,8918	5,9963
261,40	48,00	781,420	24,284	1141,90	2795,80	2,8978	5,9917
262,04	48,50	780,400	24,550	1145,10	2795,40	2,9036	5,9871
262,68	49,00	779,380	24,816	1148,30	2795,00	2,9095	5,9826
263,31	49,50	778,370	25,084	1151,50	2794,60	2,9153	5,9781
263,94	50,00	777,370	25,351	1154,60	2794,20	2,9210	5,9737
264,56	50,50	776,370	25,619	1157,80	2793,80	2,9267	5,9692
265,18	51,00	775,370	25,888	1160,90	2793,40	2,9323	5,9648
265,79	51,50	774,380	26,157	1164,00	2792,90	2,9380	5,9605
266,40	52,00	773,390	26,427	1167,00	2792,50	2,9435	5,9561
267,01	52,50	772,400	26,697	1170,10	2792,00	2,9491	5,9518
267,61	53,00	771,420	26,968	1173,10	2791,60	2,9546	5,9475
268,20	53,50	770,440	27,240	1176,10	2791,10	2,9600	5,9433
268,79	54,00	769,460	27,512	1179,10	2790,70	2,9654	5,9391
269,38	54,50	768,490	27,784	1182,10	2790,20	2,9708	5,9348
269,97	55,00	767,520	28,057	1185,10	2789,70	2,9762	5,9307
270,54	55,50	766,550	28,331	1188,00	2789,20	2,9815	5,9265
271,12	56,00	765,590	28,605	1191,00	2788,70	2,9868	5,9224
271,69	56,50	764,630	28,879	1193,90	2788,20	2,9920	5,9183
272,26	57,00	763,670	29,155	1196,80	2787,70	2,9972	5,9142
272,82	57,50	762,720	29,431	1199,70	2787,20	3,0024	5,9101
273,38	58,00	761,770	29,707	1202,60	2786,70	3,0075	5,9061
273,94	58,50	760,820	29,984	1205,40	2786,20	3,0126	5,9021
274,49	59,00	759,880	30,262	1208,30	2785,70	3,0177	5,8981

Temperature °C	Absolute pressure bar	Liquid density kg/m <sup>3</sup>	Vapor density kg/m <sup>3</sup>	Liquid Enthalpy kJ/kg	Vapor Enthalpy kJ/kg	Liquid Entropy kJ/kg-K	Vapor Entropy kJ/kg-K
275,04	59,50	758,940	30,540	1211,10	2785,10	3,0228	5,8941
275,58	60,00	758,000	30,818	1213,90	2784,60	3,0278	5,8901
276,13	60,50	757,060	31,098	1216,70	2784,00	3,0328	5,8862
276,67	61,00	756,130	31,378	1219,50	2783,50	3,0377	5,8823
277,20	61,50	755,200	31,658	1222,30	2782,90	3,0427	5,8784
277,73	62,00	754,270	31,940	1225,10	2782,40	3,0476	5,8745
278,26	62,50	753,340	32,221	1227,80	2781,80	3,0524	5,8706
278,79	63,00	752,420	32,504	1230,50	2781,20	3,0573	5,8668
279,31	63,50	751,500	32,787	1233,30	2780,60	3,0621	5,8630
279,83	64,00	750,580	33,070	1236,00	2780,10	3,0669	5,8592
280,34	64,50	749,660	33,355	1238,70	2779,50	3,0716	5,8554
280,86	65,00	748,750	33,640	1241,40	2778,90	3,0764	5,8516
281,37	65,50	747,840	33,925	1244,10	2778,30	3,0811	5,8478
281,87	66,00	746,930	34,211	1246,70	2777,70	3,0858	5,8441
282,38	66,50	746,020	34,498	1249,40	2777,10	3,0904	5,8404
282,88	67,00	745,110	34,786	1252,00	2776,40	3,0951	5,8367
283,38	67,50	744,210	35,074	1254,70	2775,80	3,0997	5,8330
283,87	68,00	743,310	35,363	1257,30	2775,20	3,1043	5,8293
284,37	68,50	742,410	35,652	1259,90	2774,60	3,1088	5,8256
284,86	69,00	741,510	35,943	1262,50	2773,90	3,1134	5,8220
285,34	69,50	740,620	36,234	1265,10	2773,30	3,1179	5,8184
285,83	70,00	739,720	36,525	1267,70	2772,60	3,1224	5,8148
286,31	70,50	738,830	36,817	1270,20	2772,00	3,1269	5,8111
286,79	71,00	737,940	37,110	1272,80	2771,30	3,1313	5,8076
287,27	71,50	737,050	37,404	1275,30	2770,70	3,1358	5,8040
287,74	72,00	736,170	37,698	1277,90	2770,00	3,1402	5,8004
288,21	72,50	735,280	37,993	1280,40	2769,30	3,1446	5,7969
288,68	73,00	734,400	38,289	1282,90	2768,60	3,1489	5,7933
289,15	73,50	733,520	38,585	1285,40	2768,00	3,1533	5,7898
289,61	74,00	732,640	38,883	1287,90	2767,30	3,1576	5,7863
290,08	74,50	731,760	39,181	1290,40	2766,60	3,1619	5,7828
290,54	75,00	730,880	39,479	1292,90	2765,90	3,1662	5,7793
290,99	75,50	730,010	39,779	1295,40	2765,20	3,1705	5,7758
291,45	76,00	729,140	40,079	1297,90	2764,50	3,1747	5,7723
291,90	76,50	728,260	40,380	1300,30	2763,80	3,1789	5,7689
292,35	77,00	727,390	40,681	1302,80	2763,10	3,1832	5,7654
292,80	77,50	726,520	40,983	1305,20	2762,30	3,1874	5,7620
293,25	78,00	725,660	41,287	1307,70	2761,60	3,1915	5,7586
293,69	78,50	724,790	41,591	1310,10	2760,90	3,1957	5,7552
294,13	79,00	723,920	41,895	1312,50	2760,20	3,1998	5,7518
294,57	79,50	723,060	42,201	1314,90	2759,40	3,2040	5,7484



Temperature °C	Absolute pressure bar	Liquid density kg/m <sup>3</sup>	Vapor density kg/m <sup>3</sup>	Liquid Enthalpy kJ/kg	Vapor Enthalpy kJ/kg	Liquid Entropy kJ/kg-K	Vapor Entropy kJ/kg-K
295,01	80,00	722,200	42,507	1317,30	2758,70	3,2081	5,7450
295,44	80,50	721,330	42,814	1319,70	2757,90	3,2122	5,7416
295,88	81,00	720,470	43,122	1322,10	2757,20	3,2162	5,7383
296,31	81,50	719,620	43,430	1324,50	2756,40	3,2203	5,7349
296,74	82,00	718,760	43,740	1326,80	2755,70	3,2243	5,7316
297,16	82,50	717,900	44,050	1329,20	2754,90	3,2284	5,7282
297,59	83,00	717,040	44,361	1331,60	2754,10	3,2324	5,7249
298,01	83,50	716,190	44,673	1333,90	2753,40	3,2364	5,7216
298,43	84,00	715,340	44,985	1336,30	2752,60	3,2403	5,7183
298,85	84,50	714,480	45,299	1338,60	2751,80	3,2443	5,7150
299,27	85,00	713,630	45,613	1340,90	2751,00	3,2483	5,7117
299,69	85,50	712,780	45,928	1343,30	2750,20	3,2522	5,7084
300,10	86,00	711,930	46,244	1345,60	2749,40	3,2561	5,7051
300,51	86,50	711,080	46,561	1347,90	2748,60	3,2600	5,7018
300,92	87,00	710,230	46,879	1350,20	2747,80	3,2639	5,6986
301,33	87,50	709,390	47,198	1352,50	2747,00	3,2678	5,6953
301,74	88,00	708,540	47,517	1354,80	2746,20	3,2717	5,6921
302,14	88,50	707,690	47,837	1357,10	2745,40	3,2755	5,6888
302,54	89,00	706,850	48,159	1359,30	2744,60	3,2793	5,6856
302,95	89,50	706,010	48,481	1361,60	2743,80	3,2832	5,6824
303,34	90,00	705,160	48,804	1363,90	2742,90	3,2870	5,6791
303,74	90,50	704,320	49,128	1366,10	2742,10	3,2908	5,6759
304,14	91,00	703,480	49,453	1368,40	2741,30	3,2946	5,6727
304,53	91,50	702,640	49,778	1370,60	2740,40	3,2983	5,6695
304,93	92,00	701,800	50,105	1372,90	2739,60	3,3021	5,6663
305,32	92,50	700,960	50,433	1375,10	2738,70	3,3058	5,6631
305,71	93,00	700,120	50,761	1377,40	2737,90	3,3096	5,6599
306,09	93,50	699,280	51,091	1379,60	2737,00	3,3133	5,6568
306,48	94,00	698,440	51,421	1381,80	2736,20	3,3170	5,6536
306,87	94,50	697,600	51,753	1384,00	2735,30	3,3207	5,6504
307,25	95,00	696,770	52,085	1386,20	2734,40	3,3244	5,6473
307,63	95,50	695,930	52,418	1388,40	2733,60	3,3281	5,6441
308,01	96,00	695,090	52,753	1390,60	2732,70	3,3317	5,6410
308,39	96,50	694,260	53,088	1392,80	2731,80	3,3354	5,6378
308,77	97,00	693,420	53,424	1395,00	2730,90	3,3390	5,6347
309,14	97,50	692,590	53,761	1397,20	2730,00	3,3427	5,6316
309,52	98,00	691,760	54,100	1399,40	2729,10	3,3463	5,6284
309,89	98,50	690,920	54,439	1401,60	2728,20	3,3499	5,6253
310,26	99,00	690,090	54,779	1403,70	2727,30	3,3535	5,6222
310,63	99,50	689,260	55,121	1405,90	2726,40	3,3571	5,6191
311,00	100,00	688,420	55,463	1408,10	2725,50	3,3606	5,6160



## A.2 Saturated Liquid and Vapor Properties (by Temperature)

Temperature °C	Absolute pressure bar	Liquid density kg/m <sup>3</sup>	Vapor density kg/m <sup>3</sup>	Liquid Enthalpy kJ/kg	Vapor Enthalpy kJ/kg	Liquid Entropy kJ/kg-K	Vapor Entropy kJ/kg-K
10	0,01	999,650	0,009	42,02	2519,20	0,1511	8,8998
20	0,02	998,160	0,017	83,91	2537,40	0,2965	8,6660
30	0,04	995,610	0,030	125,73	2555,50	0,4368	8,4520
40	0,07	992,180	0,051	167,53	2573,50	0,5724	8,2555
50	0,12	988,000	0,083	209,34	2591,30	0,7038	8,0748
60	0,20	983,160	0,130	251,18	2608,80	0,8313	7,9081
70	0,31	977,730	0,198	293,07	2626,10	0,9551	7,7540
80	0,47	971,770	0,294	335,01	2643,00	1,0756	7,6111
90	0,70	965,300	0,424	377,04	2659,50	1,1929	7,4781
99,61	1,00	958,630	0,590	417,50	2674,90	1,3028	7,3588
100	1,01	958,350	0,598	419,17	2675,60	1,3072	7,3541
110	1,43	950,950	0,827	461,42	2691,10	1,4188	7,2381
120	1,99	943,110	1,122	503,81	2705,90	1,5279	7,1291
130	2,70	934,830	1,497	546,38	2720,10	1,6346	7,0264
140	3,62	926,130	1,967	589,16	2733,40	1,7392	6,9293
150	4,76	917,010	2,548	632,18	2745,90	1,8418	6,8371
160	6,18	907,450	3,260	675,47	2757,40	1,9426	6,7491
170	7,92	897,450	4,122	719,08	2767,90	2,0417	6,6650
180	10,03	887,000	5,159	763,05	2777,20	2,1392	6,5840
190	12,55	876,080	6,395	807,43	2785,30	2,2355	6,5059
200	15,55	864,660	7,861	852,27	2792,00	2,3305	6,4302
210	19,08	852,720	9,589	897,63	2797,30	2,4245	6,3563
220	23,20	840,220	11,615	943,58	2800,90	2,5177	6,2840
230	27,97	827,120	13,985	990,19	2802,90	2,6101	6,2128
240	33,47	813,370	16,749	1037,60	2803,00	2,7020	6,1423
250	39,76	798,890	19,967	1085,80	2800,90	2,7935	6,0721
260	46,92	783,630	23,712	1135,00	2796,60	2,8849	6,0016
270	55,03	767,460	28,073	1185,30	2789,70	2,9765	5,9304
280	64,17	750,280	33,165	1236,90	2779,90	3,0685	5,8579
290	74,42	731,910	39,132	1290,00	2766,70	3,1612	5,7834
300	85,88	712,140	46,168	1345,00	2749,60	3,2552	5,7059
310	98,65	690,670	54,541	1402,20	2727,90	3,3510	5,6244
311	100,00	688,420	55,463	1408,10	2725,50	3,3606	5,6160



### A.3 Superheated Vapor Properties (by Pressure)

Temperature °C	Absolute pressure bar	Density kg/m <sup>3</sup>	Enthalpy kJ/kg	Entropy kJ/kg-K
120	1,0	0,558	2716,60	7,4678
140	1,0	0,529	2756,70	7,5672
160	1,0	0,504	2796,40	7,6610
180	1,0	0,481	2836,00	7,7503
200	1,0	0,460	2875,50	7,8356
140	3,0	1,621	2739,40	7,0269
160	3,0	1,537	2782,60	7,1291
180	3,0	1,462	2824,60	7,2239
200	3,0	1,396	2865,90	7,3131
220	3,0	1,336	2906,80	7,3978
180	7,0	3,512	2799,40	6,7893
200	7,0	3,333	2845,30	6,8884
220	7,0	3,177	2889,50	6,9799
240	7,0	3,037	2932,70	7,0658
260	7,0	2,912	2975,20	7,1472
200	10,0	4,854	2828,30	6,6955
220	10,0	4,609	2875,50	6,7934
240	10,0	4,394	2920,90	6,8836
260	10,0	4,204	2965,10	6,9681
280	10,0	4,032	3008,60	7,0482
220	15,0	7,110	2850,20	6,5659
240	15,0	6,743	2900,00	6,6649
260	15,0	6,425	2947,40	6,7555
280	15,0	6,144	2993,30	6,8400
300	15,0	5,893	3038,20	6,9198
220	20,0	9,787	2821,60	6,3867
240	20,0	9,217	2877,20	6,4973
260	20,0	8,740	2928,50	6,5952
280	20,0	8,330	2977,10	6,6849
300	20,0	7,968	3024,20	6,7684
250	25,0	11,487	2880,90	6,4107
275	25,0	10,732	2947,40	6,5350
300	25,0	10,107	3009,60	6,6459
325	25,0	9,574	3069,10	6,7476
350	25,0	9,109	3127,00	6,8424
375	25,0	8,696	3183,90	6,9319
400	25,0	8,325	3240,10	7,0170
275	40,0	18,313	2887,30	6,2312
300	40,0	16,987	2961,70	6,3639
325	40,0	15,928	3029,50	6,4797

Temperature °C	Absolute pressure bar	Density kg/m <sup>3</sup>	Enthalpy kJ/kg	Entropy kJ/kg-K
350	40,0	15,044	3093,30	6,5843
375	40,0	14,284	3154,70	6,6809
400	40,0	13,618	3214,50	6,7714
425	40,0	13,026	3273,20	6,8570
300	60,0	27,632	2885,50	6,0703
325	60,0	25,389	2969,50	6,2137
350	60,0	23,668	3043,90	6,3357
375	60,0	22,269	3112,80	6,4441
400	60,0	21,088	3178,20	6,5432
425	60,0	20,068	3241,40	6,6352
450	60,0	19,170	3302,90	6,7219
300	80,0	41,188	2786,50	5,7937
325	80,0	36,488	2898,40	5,9851
350	80,0	33,361	2988,10	6,1321
375	80,0	31,007	3066,90	6,2561
400	80,0	29,117	3139,40	6,3658
425	80,0	27,538	3207,70	6,4655
450	80,0	26,182	3273,30	6,5579
325	100,0	50,308	2810,30	5,7596
350	100,0	44,564	2924,00	5,9459
375	100,0	40,719	3016,30	6,0911
400	100,0	37,827	3097,40	6,2141
425	100,0	35,509	3172,00	6,3229
450	100,0	33,578	3242,30	6,4219
475	100,0	31,923	3309,70	6,5135



## A.4 Subcooled Liquid Properties (by Pressure)

Temperature °C	Absolute pressure bar	Density kg/m <sup>3</sup>	Enthalpy kJ/kg	Entropy kJ/kg-K
90	1,01	965,310	377,06	1,1928
65	1,01	980,550	272,18	0,8936
40	1,01	992,220	167,62	0,5724
10	1,01	999,700	42,119	0,1511
90	3,0	965,400	377,22	1,1927
65	3,0	980,640	272,34	0,8935
90	7,0	965,580	377,53	1,1924
65	7,0	980,810	272,68	0,8933
90	10,0	965,720	377,76	1,1922
65	10,0	980,950	272,92	0,8931
90	15,0	965,950	378,15	1,1918
65	15,0	981,160	273,34	0,8928
90	20,0	966,180	378,53	1,1915
65	20,0	981,380	273,75	0,8925
90	25,0	966,400	378,92	1,1911
65	25,0	981,600	274,17	0,8923
90	40,0	967,090	380,08	1,1900
65	40,0	982,260	275,41	0,8914
90	60,0	967,990	381,63	1,1886
65	60,0	983,120	277,07	0,8903
90	80,0	968,890	383,18	1,1872
65	80,0	983,990	278,72	0,8892
90	100,0	969,780	384,73	1,1858
65	100,0	984,850	280,38	0,8881

# APPENDIX B: STACK LOSS TABLES

(Based on Combustion Model developed by Greg Harrell, Ph.D., P.E., EMSCAS)

## B.1 Fuel Composition

Fuel composition and properties Component	Coal (Bituminous) Water -4%; Ash -7%		Coal (Bituminous) Water -5%; Ash -35%		Coal (Bituminous) Water -10%; Ash -15%		Green Wood		Natural Gas	
	Mole Fraction [lbmol/lbm <sub>fuel</sub> ]	Mass Fraction [lbm/lbm <sub>fuel</sub> ]	Mole Fraction [lbmol/lbm <sub>fuel</sub> ]	Mass Fraction [lbm/lbm <sub>fuel</sub> ]	Mole Fraction [lbmol/lbm <sub>fuel</sub> ]	Mass Fraction [lbm/lbm <sub>fuel</sub> ]	Mole Fraction [lbmol/lbm <sub>fuel</sub> ]	Mass Fraction [lbm/lbm <sub>fuel</sub> ]	Mole Fraction [lbmol/lbm <sub>fuel</sub> ]	Mass Fraction [lbm/lbm <sub>fuel</sub> ]
C	0,6709	0,7500	0,4942	0,4400	0,6539	0,6300	0,1234	0,0500	0,0000	0,0000
H <sub>2</sub>	0,2662	0,0500	0,3677	0,0550	0,2224	0,0360	0,0000	0,0000	0,0000	0,0000
CH <sub>4</sub>	0,0000	0,0000	0,0000	0,0000	0,0000	0,0000	0,0000	0,0000	0,9490	0,9053
N <sub>2</sub>	0,0057	0,0150	0,0144	0,0300	0,0080	0,0180	0,0000	0,0000	0,0110	0,0183
CO	0,0000	0,0000	0,0000	0,0000	0,0000	0,0000	0,0000	0,0000	0,0000	0,0000
C <sub>2</sub> H <sub>4</sub> (Ethylene)	0,0000	0,0000	0,0000	0,0000	0,0000	0,0000	0,0000	0,0000	0,0000	0,0000
C <sub>2</sub> H <sub>6</sub> (Ethane)	0,0000	0,0000	0,0000	0,0000	0,0000	0,0000	0,0000	0,0000	0,0340	0,0607
C <sub>3</sub> H <sub>8</sub> (Propane)	0,0000	0,0000	0,0000	0,0000	0,0000	0,0000	0,0000	0,0000	0,0060	0,0157
O <sub>2</sub>	0,0225	0,0670	0,0295	0,0700	0,0210	0,0540	0,0000	0,0000	0,0000	0,0000
S	0,0033	0,0100	0,0021	0,0050	0,0035	0,0090	0,0004	0,0004	0,0000	0,0000
H <sub>2</sub> O (intrinsic)	0,0226	0,0380	0,0374	0,0500	0,0691	0,1000	0,7889	0,4800	0,0000	0,0000
H <sub>2</sub> O (extrinsic)	0,0000	0,0000	0,0000	0,0000	0,0000	0,0000	0,0000	0,0000	0,0000	0,0000
CO <sub>2</sub>	0,0000	0,0000	0,0000	0,0000	0,0000	0,0000	0,0000	0,0000	0,0000	0,0000
C <sub>6</sub> H <sub>10</sub> O <sub>5</sub> (Cellulose)	0,0000	0,0000	0,0000	0,0000	0,0000	0,0000	0,0839	0,4596	0,0000	0,0000
<b>Ash (Total)</b>	<b>0,0087</b>	<b>0,0700</b>	<b>0,0546</b>	<b>0,3500</b>	<b>0,0221</b>	<b>0,1530</b>	<b>0,0034</b>	<b>0,0100</b>	<b>0,0000</b>	<b>0,0000</b>
<b>Ash Components</b>										
Al <sub>2</sub> O <sub>3</sub>	0,0015	0,0147	0,0097	0,0735	0,0039	0,0321	0,0006	0,0021	0,0000	0,0000
SiO <sub>2</sub>	0,0055	0,0308	0,0345	0,1540	0,0140	0,0673	0,0022	0,0044	0,0000	0,0000
Fe <sub>2</sub> O <sub>3</sub>	0,0016	0,0245	0,0103	0,1225	0,0042	0,0536	0,0006	0,0035	0,0000	0,0000
<b>Total</b>	<b>1,0000</b>	<b>1,0000</b>	<b>1,0000</b>	<b>1,0000</b>	<b>1,0000</b>	<b>1,0000</b>	<b>1,0000</b>	<b>1,0000</b>	<b>1,0000</b>	<b>1,0000</b>
Fuel Molecular Weight	kgm <sub>fuel</sub> /kgmol <sub>fuel</sub>	10,7340	13,4790	12,4549	29,6086	16,8182				
Fuel Higher Heating Value	kJ/kg	31 788	22 282	25 857	9 666	54 205				
Fuel Lower Heating Value	kJ/kg	30 603	20 958	24 826	7 869	48 906				



## B.2 Stack Loss for Natural Gas

Stack Loss Table for Natural Gas														
Flue Gas Oxygen Content Wet Basis [%]	Flue Gas Oxygen Content Dry Basis [%]	Comb Conc [ppm]	Stack Loss [% of fuel Higher Heating Value input]											
			Net Stack Temperature [ $\Delta^{\circ}\text{C}$ ] {Difference between flue exhaust temperature and ambient temperature}											
			100	120	140	160	180	200	220	240	260	280	300	320
1,0	1,2	0	13,6	14,4	15,2	15,9	16,7	17,5	18,3	19,1	19,9	20,7	21,5	22,3
2,0	2,4	0	13,8	14,6	15,4	16,2	17,1	17,9	18,7	19,6	20,4	21,3	22,1	23,0
3,0	3,6	0	14,0	14,8	15,7	16,6	17,4	18,3	19,2	20,1	21,0	21,9	22,7	23,6
4,0	4,7	0	14,2	15,1	16,0	16,9	17,9	18,8	19,7	20,6	21,6	22,5	23,5	24,4
5,0	5,8	0	14,5	15,4	16,4	17,4	18,3	19,3	20,3	21,3	22,3	23,3	24,3	25,3
6,0	6,9	0	14,8	15,8	16,8	17,8	18,9	19,9	21,0	22,0	23,1	24,1	25,2	26,2
7,0	8,0	0	15,1	16,2	17,3	18,4	19,5	20,6	21,7	22,8	24,0	25,1	26,2	27,3
8,0	9,1	0	15,5	16,7	17,8	19,0	20,2	21,4	22,6	23,8	25,0	26,2	27,4	28,6
9,0	10,1	0	15,9	17,2	18,5	19,7	21,0	22,3	23,6	24,9	26,2	27,5	28,8	30,1
10,0	11,1	0	16,5	17,9	19,2	20,6	22,0	23,4	24,8	26,2	27,6	29,0	30,5	31,9
Actual Exhaust T [ $^{\circ}\text{C}$ ]			120	140	160	180	200	220	240	260	280	300	320	340
Ambient T [ $^{\circ}\text{C}$ ]			20	20	20	20	20	20	20	20	20	20	20	20

## B.3 Stack Loss for #2 Fuel Oil

Stack Loss Table for Number 2 Fuel Oil														
Flue Gas Oxygen Content Wet Basis [%]	Flue Gas Oxygen Content Dry Basis [%]	Comb Conc [ppm]	Stack Loss [% of fuel Higher Heating Value input]											
			Net Stack Temperature [ $\Delta^{\circ}\text{C}$ ] {Difference between flue exhaust temperature and ambient temperature}											
			120	140	160	180	200	220	240	260	280	300	320	340
1,0	1,1	0	10,2	11,0	11,7	12,5	13,2	14,0	14,8	15,6	16,3	17,1	17,9	18,7
2,0	2,2	0	10,4	11,2	12,0	12,8	13,6	14,4	15,2	16,0	16,8	17,7	18,5	19,3
3,0	3,3	0	10,7	11,5	12,3	13,2	14,0	14,8	15,7	16,6	17,4	18,3	19,1	20,0
4,0	4,4	0	10,9	11,8	12,7	13,6	14,5	15,3	16,2	17,1	18,1	19,0	19,9	20,8
5,0	5,5	0	11,2	12,1	13,1	14,0	15,0	15,9	16,9	17,8	18,8	19,7	20,7	21,7
6,0	6,5	0	11,6	12,5	13,5	14,5	15,5	16,5	17,5	18,6	19,6	20,6	21,6	22,7
7,0	7,6	0	11,9	13,0	14,1	15,1	16,2	17,3	18,3	19,4	20,5	21,6	22,7	23,8
8,0	8,6	0	12,4	13,5	14,7	15,8	16,9	18,1	19,3	20,4	21,6	22,8	23,9	25,1
9,0	9,6	0	12,9	14,1	15,4	16,6	17,8	19,1	20,3	21,6	22,8	24,1	25,4	26,6
10,0	10,7	0	13,5	14,9	16,2	17,5	18,9	20,2	21,6	22,9	24,3	25,7	27,1	28,4
Actual Exhaust T [ $^{\circ}\text{C}$ ]			140	160	180	200	220	240	260	280	300	320	340	360
Ambient T [ $^{\circ}\text{C}$ ]			20	20	20	20	20	20	20	20	20	20	20	20

## B.4 Stack Loss for #6 Fuel Oil

Stack Loss Table for Number 6 Fuel Oil														
Flue Gas Oxygen Content Wet Basis [%]	Flue Gas Oxygen Content Dry Basis [%]	Comb Conc [ppm]	Stack Loss [% of fuel Higher Heating Value input]											
			Net Stack Temperature [ $\Delta^{\circ}\text{C}$ ] {Difference between flue exhaust temperature and ambient temperature}											
			120	140	160	180	200	220	240	260	280	300	320	340
1,0	1,1	0	9,5	10,3	11,1	11,8	12,6	13,4	14,2	14,9	15,7	16,5	17,3	18,1
2,0	2,2	0	9,8	10,6	11,4	12,2	13,0	13,8	14,6	15,4	16,3	17,1	17,9	18,7
3,0	3,3	0	10,0	10,8	11,7	12,5	13,4	14,2	15,1	16,0	16,8	17,7	18,6	19,4
4,0	4,4	0	10,3	11,2	12,0	12,9	13,8	14,7	15,6	16,6	17,5	18,4	19,3	20,2
5,0	5,4	0	10,6	11,5	12,4	13,4	14,3	15,3	16,3	17,2	18,2	19,2	20,1	21,1
6,0	6,5	0	10,9	11,9	12,9	13,9	14,9	15,9	17,0	18,0	19,0	20,0	21,1	22,1
7,0	7,5	0	11,3	12,4	13,4	14,5	15,6	16,7	17,8	18,9	20,0	21,1	22,2	23,3
8,0	8,5	0	11,8	12,9	14,0	15,2	16,4	17,5	18,7	19,9	21,0	22,2	23,4	24,6
9,0	9,6	0	12,3	13,5	14,8	16,0	17,2	18,5	19,8	21,0	22,3	23,6	24,8	26,1
10,0	10,6	0	12,9	14,2	15,6	16,9	18,3	19,7	21,0	22,4	23,8	25,2	26,6	28,0
Actual Exhaust T [ $^{\circ}\text{C}$ ]			140	160	180	200	220	240	260	280	300	320	340	360
Ambient T [ $^{\circ}\text{C}$ ]			20	20	20	20	20	20	20	20	20	20	20	20

## B.5 Stack Loss for Bituminous Coal (Water – 4%; Ash – 7%)

Stack Loss Table for Coal-Bituminous-Water 4%-Ash 7%														
Flue Gas Oxygen Content Wet Basis [%]	Flue Gas Oxygen Content Dry Basis [%]	Comb Conc [ppm]	Stack Loss [% of fuel Higher Heating Value input]											
			Net Stack Temperature [ $\Delta^{\circ}\text{C}$ ] {Difference between flue exhaust temperature and ambient temperature}											
			120	140	160	180	200	220	240	260	280	300	320	340
1,0	1,1	0	8,2	9,0	9,8	10,6	11,3	12,1	12,9	13,7	14,5	15,3	16,1	16,9
2,0	2,1	0	8,4	9,3	10,1	10,9	11,7	12,5	13,4	14,2	15,0	15,9	16,7	17,6
3,0	3,2	0	8,7	9,5	10,4	11,3	12,1	13,0	13,9	14,7	15,6	16,5	17,4	18,3
4,0	4,3	0	9,0	9,9	10,8	11,7	12,6	13,5	14,4	15,3	16,3	17,2	18,1	19,1
5,0	5,3	0	9,3	10,2	11,2	12,1	13,1	14,1	15,0	16,0	17,0	18,0	19,0	20,0
6,0	6,3	0	9,6	10,6	11,6	12,6	13,7	14,7	15,7	16,8	17,8	18,9	19,9	21,0
7,0	7,4	0	10,0	11,1	12,2	13,2	14,3	15,4	16,5	17,6	18,8	19,9	21,0	22,1
8,0	8,4	0	10,5	11,6	12,8	13,9	15,1	16,3	17,5	18,7	19,8	21,0	22,2	23,5
9,0	9,4	0	11,0	12,2	13,5	14,7	16,0	17,3	18,5	19,8	21,1	22,4	23,7	25,0
10,0	10,4	0	11,6	13,0	14,3	15,7	17,1	18,4	19,8	21,2	22,6	24,0	25,4	26,8
Actual Exhaust T [ $^{\circ}\text{C}$ ]			140	160	180	200	220	240	260	280	300	320	340	360
Ambient T [ $^{\circ}\text{C}$ ]			20	20	20	20	20	20	20	20	20	20	20	20



## B.6 Stack Loss for Bituminous Coal (Water – 5%; Ash – 35%)

Stack Loss Table for Coal-Bituminous-Water 5%-Ash 35%														
Flue Gas Oxygen Content Wet Basis [%]	Flue Gas Oxygen Content Dry Basis [%]	Comb Conc [ppm]	Stack Loss [% of fuel Higher Heating Value input]											
			Net Stack Temperature [ $\Delta^{\circ}\text{C}$ ] {Difference between flue exhaust temperature and ambient temperature}											
			120	140	160	180	200	220	240	260	280	300	320	340
1,0	1,1	0	10,4	11,2	12,0	12,8	13,6	14,4	15,2	16,0	16,8	17,6	18,4	19,2
2,0	2,2	0	10,7	11,5	12,3	13,1	13,9	14,8	15,6	16,4	17,3	18,1	19,0	19,8
3,0	3,4	0	10,9	11,7	12,6	13,5	14,3	15,2	16,1	17,0	17,8	18,7	19,6	20,5
4,0	4,4	0	11,2	12,1	13,0	13,9	14,8	15,7	16,6	17,5	18,5	19,4	20,3	21,3
5,0	5,5	0	11,5	12,4	13,4	14,3	15,3	16,2	17,2	18,2	19,2	20,2	21,1	22,1
6,0	6,6	0	11,8	12,8	13,8	14,8	15,8	16,9	17,9	18,9	20,0	21,0	22,1	23,1
7,0	7,6	0	12,2	13,2	14,3	15,4	16,5	17,6	18,7	19,8	20,9	22,0	23,1	24,2
8,0	8,6	0	12,6	13,8	14,9	16,1	17,2	18,4	19,6	20,8	22,0	23,1	24,3	25,5
9,0	9,7	0	13,1	14,4	15,6	16,9	18,1	19,4	20,6	21,9	23,2	24,5	25,8	27,1
10,0	10,7	0	13,7	15,1	16,4	17,8	19,1	20,5	21,9	23,3	24,7	26,0	27,4	28,8
Actual Exhaust T [ $^{\circ}\text{C}$ ]			140	160	180	200	220	240	260	280	300	320	340	360
Ambient T [ $^{\circ}\text{C}$ ]			20	20	20	20	20	20	20	20	20	20	20	20

## B.7 Stack Loss for Bituminous Coal (Water – 10%; Ash – 15%)

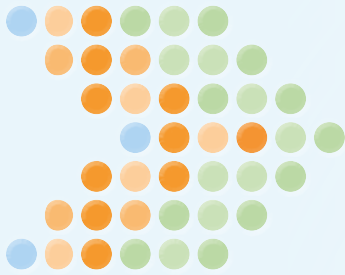
Stack Loss Table for Coal-Bituminous-Water 10%-Ash 15%														
Flue Gas Oxygen Content Wet Basis [%]	Flue Gas Oxygen Content Dry Basis [%]	Comb Conc [ppm]	Stack Loss [% of fuel Higher Heating Value input]											
			Net Stack Temperature [ $\Delta^{\circ}\text{C}$ ] {Difference between flue exhaust temperature and ambient temperature}											
			120	140	160	180	200	220	240	260	280	300	320	340
1,0	1,1	0	8,6	9,4	10,2	11,0	11,8	12,6	13,4	14,3	15,1	15,9	16,7	17,6
2,0	2,2	0	8,8	9,7	10,5	11,3	12,2	13,0	13,9	14,7	15,6	16,5	17,3	18,2
3,0	3,2	0	9,1	9,9	10,8	11,7	12,6	13,5	14,4	15,3	16,2	17,1	18,0	18,9
4,0	4,3	0	9,3	10,3	11,2	12,1	13,1	14,0	15,0	15,9	16,9	17,8	18,8	19,7
5,0	5,3	0	9,7	10,6	11,6	12,6	13,6	14,6	15,6	16,6	17,6	18,6	19,6	20,7
6,0	6,4	0	10,0	11,0	12,1	13,1	14,2	15,2	16,3	17,4	18,4	19,5	20,6	21,7
7,0	7,4	0	10,4	11,5	12,6	13,7	14,9	16,0	17,1	18,3	19,4	20,5	21,7	22,9
8,0	8,4	0	10,9	12,1	13,2	14,4	15,6	16,9	18,1	19,3	20,5	21,7	23,0	24,2
9,0	9,4	0	11,4	12,7	14,0	15,3	16,6	17,9	19,2	20,5	21,8	23,1	24,5	25,8
10,0	10,4	0	12,1	13,4	14,8	16,2	17,6	19,1	20,5	21,9	23,3	24,8	26,2	27,7
Actual Exhaust T [ $^{\circ}\text{C}$ ]			140	160	180	200	220	240	260	280	300	320	340	360
Ambient T [ $^{\circ}\text{C}$ ]			20	20	20	20	20	20	20	20	20	20	20	20



## B.8 Stack Loss for Green Wood

Stack Loss Table for Green-Wood Typical														
Flue Gas Oxygen Content Wet Basis [%]	Flue Gas Oxygen Content Dry Basis [%]	Comb Conc [ppm]	Stack Loss [% of fuel Higher Heating Value input]											
			Net Stack Temperature [ $\Delta^{\circ}\text{C}$ ] {Difference between flue exhaust temperature and ambient temperature}											
			120	140	160	180	200	220	240	260	280	300	320	340
1,0	1,4	0	24,5	25,5	26,5	27,5	28,6	29,6	30,6	31,7	32,7	33,8	34,8	35,9
2,0	2,7	0	24,7	25,8	26,9	27,9	29,0	30,1	31,2	32,3	33,4	34,5	35,6	36,7
3,0	4,0	0	25,1	26,2	27,3	28,4	29,5	30,7	31,8	33,0	34,1	35,3	36,4	37,6
4,0	5,2	0	25,4	26,6	27,8	28,9	30,1	31,3	32,5	33,7	35,0	36,2	37,4	38,6
5,0	6,4	0	25,8	27,0	28,3	29,5	30,8	32,1	33,3	34,6	35,9	37,2	38,5	39,8
6,0	7,6	0	26,2	27,5	28,9	30,2	31,5	32,9	34,2	35,6	36,9	38,3	39,7	41,0
7,0	8,7	0	26,7	28,1	29,5	31,0	32,4	33,8	35,2	36,7	38,1	39,6	41,0	42,5
8,0	9,7	0	27,3	28,8	30,3	31,8	33,4	34,9	36,4	38,0	39,5	41,1	42,6	44,2
9,0	10,8	0	28,0	29,6	31,2	32,9	34,5	36,2	37,8	39,5	41,1	42,8	44,5	46,2
10,0	11,8	0	28,8	30,5	32,3	34,1	35,9	37,6	39,4	41,2	43,1	44,9	46,7	48,5
Actual Exhaust T [ $^{\circ}\text{C}$ ]			140	160	180	200	220	240	260	280	300	320	340	360
Ambient T [ $^{\circ}\text{C}$ ]			20	20	20	20	20	20	20	20	20	20	20	20





UNIDO helps raise the business potential of industry by introducing and enhancing energy management practices and accounting methods. The present Manual for Industrial Steam Systems Assessment and Optimization seeks to provide direction and support to companies seeking to optimize their existing steam systems and an additional knowledge resource for industrial energy efficiency service providers.



**TOGETHER**  
*for a sustainable future*

Vienna International Centre · P.O. Box 300 · 1400 Vienna · Austria  
Tel.: (+43-1) 26026-0 · [unido@unido.org](mailto:unido@unido.org)  
[www.unido.org](http://www.unido.org)