



TOGETHER
for a sustainable future

OCCASION

This publication has been made available to the public on the occasion of the 50th anniversary of the United Nations Industrial Development Organisation.



TOGETHER
for a sustainable future

DISCLAIMER

This document has been produced without formal United Nations editing. The designations employed and the presentation of the material in this document do not imply the expression of any opinion whatsoever on the part of the Secretariat of the United Nations Industrial Development Organization (UNIDO) concerning the legal status of any country, territory, city or area or of its authorities, or concerning the delimitation of its frontiers or boundaries, or its economic system or degree of development. Designations such as “developed”, “industrialized” and “developing” are intended for statistical convenience and do not necessarily express a judgment about the stage reached by a particular country or area in the development process. Mention of firm names or commercial products does not constitute an endorsement by UNIDO.

FAIR USE POLICY

Any part of this publication may be quoted and referenced for educational and research purposes without additional permission from UNIDO. However, those who make use of quoting and referencing this publication are requested to follow the Fair Use Policy of giving due credit to UNIDO.

CONTACT

Please contact publications@unido.org for further information concerning UNIDO publications.

For more information about UNIDO, please visit us at www.unido.org

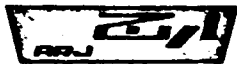

21391

ARJ CORPORATION شرکت آرج

IN THE NAME OF GOD

September 1995

CONVERSION OF DOMESTIC REFRIGERATOR PRODUCTION
FACILITIES AT PHASE OUT CFC-11 AND CFC-12

IRAN

(Arj Company)

FINAL REPORT

Project NO. MP/IRA/94/473

UNIDO Contract 95/054/ML

PREPARED BY

Abdulreza Mohammadi

Incharge of projects

Backstopping Officer:

A. Malayeri

Engineering and Metallurgical Industries Branch

UNITED NATIONS INDUSTRIAL DEVELOPMENT ORGANIZATION

VIENNA, AUSTRIA

A. GH



CONTENT

Introduction	1
Project Back Ground	2
Summary	3
Activities	4
Determination of constant "C"	5
Redesign & Calculation	6
Selection of Components	6
Making prototypes	8
performance tests	8
Optimization of circuit & Components	10
Trail tests production	11
Training of production staff	12
Instalation of the evaluation, charging system and leak detector	12
Prototypes specifications	13
Redesign,calculation and performance test sheets for model 6246a	19
Redesign,calculation and performance test sheets for model 6247a	47
Redesign,calculation and performance test sheets for model 6243a	73
Redesign,calculation and performance test sheets for model 6202a	98
Redesign,calculation and performance test sheets for model 6249a	130
Compressor selection	162
Tasks	165
Evaluation of prototypes	166
R12 & R134a cycle comparison	173
Energy consumption evaluation	179
conclusion	181
Recommendation	183
Appendix	185
Models Schematic	198
R134a vapour tables	203
Tubing condensers tables	207
Technical compressor specifications	211
Bibliography	212



INTRODUCTION

This is the final report of extended work for conversion of domestic refrigerator to phase out CFC-12 and its replacement by HFC-134a under UNIDO - ARJ contractor.

After redesigning of the models, and the necessary changes in the refrigeration circuit for all five models, twenty prototypes (four for each model) were made and the final testing was done on them according to the ISO 7371 , In this report all activities which were made for new production have been discussed. This involved extensive data collection and consultations, so that the quality and standard of work is high and up to the UNIDO expectation. Many guidance put forward by UNIDO, were so helpful that further research work could be accomplished without difficulty . Accuracy of calculations and methods has resulted in a new model which is more efficient than before, causing saving of energy and keeping better Temperature.



BACK GROUND OF PROJECT IN COMPANY

Because of bad effect of CFCs on the environment and ecological system which has been reported by authorities, and emphasizes that without any doubt that due to the chlorine which the CFCs compounds posses the ozone layer is being damaged.

Since 1990 that the I.R. of Iran signed the montreal protocol, Arj Co. has been decided to study of new refrigerant. In this respect the R&D Dept. has kept contact with the international authorities, department of environment of Iran and many foriegn material supplier to acqiure information and latest technology for eliminating ODS CFC-12 and replacing it with the harmless new refrigerant R134a. Meanwhile members of R&D Dept. participated in different seminars and educational courses, which had been held by the universities, research center.

In April 1992 the UNIDO delegation visited the Arj Co. surveyed and made a report, in 1994 asked for redesigning making prototypes and their tests, so that the Arj production facility could produce new type of refrigerators using R134a. The R&D Dept. of Arj had worked hard with the aim of finding out a suitable refrigerant system which is compatable with the present refrigerator/freezer units . In close cooperation with the manufacturers Arj has asked them for new compressors which operate on non-CFCs . since 1994 we have received many compressor from different suppliers as samples and necessary tests have been accomplished on these samples.

After some modifications on refrigeration circuit and finalizing the test results, it is found that different types of compressors such as Necchi & Gold star are compatable and acceptable on our units.

Finally in March 1995 two refrigerators has been sent to dkk Co. in Germany that one of them was charged with R134a, After necessary tests had been accomplished on them, finalizing and comparison the results obtained by the R&D Dept. of dkk Co, the design and the components selection of R134a refrigerator has been accepted fully.

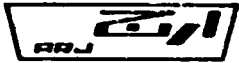

SUMMARY

This is the final report of extended work in phase out CFC-12 and its replacement by HFC-134a, covering all activities relevant to the new refrigerator /freezer models, which includes redesign and calculation, test performance , finalizing test results and optimizing the plan, for making mass production possible. The details specifications for each model are included in this report.



ACTIVITIES

The following jobs were done to introduce the new refrigerant HFC-R134a during this project.

- a) Determination of constant "C".
- b) Redesign and calculation for new R134a.
- c) Selection of components .
- d) Making prototypes .
- e) Performance tests according to ISO 7371.
- f) Optimization of circuit and components.
- g) Evaluation of prototypes and analysis.
- h) CFC-12 and HFC-R134a refrigeration comparison and review.
- i) Trial production .
- j) Training of production staff .
- k) Instalation and start up of charing system in the refrigeration work shop.

a) Determination of constant "C"

As it has already expressed in the first progress report. The cabinet constant is figure obtained practically by the below formulae:

$$C = \frac{P}{t_i - t_a} \quad \text{w/k} \quad \text{where}$$

P	Electrical power introduce to the element in watt
t _a .	Hot room Temp.in °k
t ₁ .	Inside cabinet Temp.in
t ₁ -t _a	Difference Temp.in °k
C	Cabinet constant "C" in w/k

Hence it carries high accuracy and is a factor showing the quality of insulation of the refrigerator. The cabinet constat multiplied by the area of body gives a total heat transmission load, which can be used for Calculating the compressor power

- Q = C* DT where C= U*A
 Q = Transmission load in W/k
 C = Cabinet Constant in w/k
 DT = Difference Temp. in °k
 U = Heat transfer coefficient in W/m²K
 A = Total area of the body in m²



b) Redesign & calculation

For each of five models, the redesign and calculation have been completed. it should be pointed out that the main criteria for redesign is the new design for condenser ; for each model by means of increasing the heat transfer area of condenser and by the aim of this to decrease compressor shell temperature and optimize energy consumption.

c) Selection of component

Capacity of Compressor

For the calculation of the cooling capacity of compressor we must know about following values:

- 1- *Transmission load.*
- 2- *Production load*

Determination of condenser

Knowing the "KS" value of the condenser which is given by the formulae

$$Ks = \frac{Qc \times 1.25}{DT} \quad \text{where}$$

QC = Cooling capacity of compressor in Kcal/hr

DT = Difference Temp. of Freon and ambient in °c

We can decide for suitable tube inside diameter . As it has been selected 3/16" for refrigerators and 1/4" for freezer also top freezer - refrigerator, similarly considering the width of the cabin a suitable

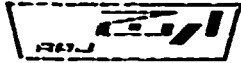

width for the condenser is taken into consideration. Now by referring to the catalogue of condenser manufacturer having the diameter and "KS" value, suitable condenser is selected.

Capacity of capillary

It depend on the condensation Temp. (ie 55 °c) and mass flow rate of refrigerant which is given by compressor manufacturer, from Molier diagram at evaporating Temp. (ie - 23.3 °c) and absolute pressure the value of liquid and vapour obtained ; therefore the capacity can be determined as follow .

Va = mass flow rate kg/hr vapour

$$m^3 /Kg \times \frac{1000}{60} = L/Min$$

Now to find out the length of capillary tube using the formulae

$$Va = 2.35 \sqrt{\frac{2}{P - 1}} \cdot a^{2.5} \cdot L^{-0.5}$$

Where

Va = Capillary capacity in L/Min.

- P = Condensation pressure Kg/Cm2 at 55 c from vapour table is known.
- a = Capillary internal diameter selected 0.79mm
- L = Length of capillary tube in mm is determined

Capacity of Evaporator

The capacity of evaporator for any specification depends on that transfer capacity to all out the vaporizing refrigerant to absorb heat at the rate necessary to produce the required cooling , when operating at designed conditions. The evaporating surface is determined by following formulae :

$$Q = U * A * DT$$



Q = Cooling capacity of evaporator is known, because it is equivalent to the colling capacity of compressor for hermatic compressor in Kcal/hr

U = Overall conductance factor $4.7 \text{ w/m}^2 \text{ K}$ for aluminium.

A = Surface area of evaporator in m to be selected.

d) Making prototypes

Totally twenty prototypes is made for five models(four for each model).

The condenser is new designed for them.

The detail specifications is mentioned in the next chapter.

e) Performance tests

All tests are accomplished according to ISO 7371

Test Procedure

All tests are done according to ISO 7371 and are performed at ambient of 43°C , 32°C and 18°C as following:

Energy consumption test

Freezing power test

Temperature rise test

The other tests ar; the pull down, the cycling, the continous run and the ice freeze test.

The test done after the pull down is the continous run test where the unit is allowed to run so long so that stablized temperature conditions



are achieved. At this stage all temperature parameters are to be recorded. Soon after this test the ice freeze test follows. In this test all the ice trays are filled with water at 10 °C where all this water changes into ice, (and the time interval is recorded,) The final test in these series is the cycling test where the thermostat by trial and error put in such position that we achieve +5 in refrigerator compartment section and -12 °C in freezer compartment. The percentage running time which creates the above mentioned characters is also recorded.

Pull Down Test

This test is performed in 43 °C ambient. Before the start of the test the door of the refrigerator are opened, and we wait for at least 24 hours when the Temp. of all parts of the refrigerator become same as the ambient now the door is closed and the electrical energy supplied then record the time after which the mean temperature of the refrigerator food liner reaches to 5 °C. The three temperature T1, T2, T3 each of them showing 1/3 height of refrigerator compartment should lay between 0 to 10 °C. This test shows the strength of the refrigerator capacity of the unit.

This test is done in an atmosphere of 32 °C. The freezer section must be loaded according to ISO Standard and the unit has been cool down to the standard conditions. The energy used in 24 hours to keep this condition study is the energy mentioned in the test report.

Temperature rise test

This test is especially designed for freezer and is performed at 32 °C. The freezer which has been brought to steady state condition is left without any electrical power and the time is noted for the warmest test package to reach -9 °C.



Storage Test

This test is done at 43 °c the freezer is first brought to the cold condition and the full load at -18 °c is introduced. The freezer should bring this load once again to -18 °c with in 24 hours.

Freezing Power Test

This test is done at 32 °c. It is expected that at least 2.5 Kg of lean meat for every 100 liter capacity of the unit can be frozed in 24 hours for this test the freezer is loaded with ballast load and is run so that the ballast load reach to -18 °c . At this stage the introduced load has to be frozen and which is at 32 °c . The freezer should be able to cool down the freezing load to -18 °c with in 24 hours.

f) Optimization of circiut & components

In this respect, the optimization of the charging of refrigeration system is done. For this purpose the refrigeration circuit charged with different values of R134a and the energy consumption noted. Condenser is also new designed to have better performance and decrease of compressor shell temp. refer the test result sheets in next chapter.



g) Evaluation of prototypes and analysis

It is a complete chapter which has discussion about this matter refer to Page no 166

h) CFC-12 & HFC-R134a refrigeration comparison & review

On page no 173 the R12 & R134a is compared considering the physical & thermodynamical properties of them.

i) Trial tests production

The following equipments were prepared for testing of twenty prototypes, included :

- * Vacuum pump
- * Charging station
- * Leak detector
- * Brazing unit
- * Thermos controllers and thermometers
- * Hot rooms

At the present time few refrigerators are under life test and more than seven months has already past and no problem aris.

According to the work plan Arj Co. is going to produce numbers of refrigerator and freezer as trial production.



j) Training of production staff

The production staff are divided to the different groups and they are attending training course which is still going on.

k) Instalation of the evacuation & charging system and leak detector .

The evacuation and charging system has already installed in the refrigeration production line and according to the work plan Arj Co. is ready to produce new production R134a for any model.

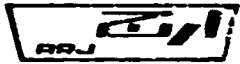

ARJ CORPORATION شرکت ارج سازان

PROTOTYPE SPECIFICATION

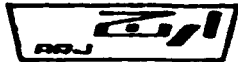

PROTOTYPES SPECIFICATIONS

COMPRESSOR SPECIFICATION

FOR MODEL 6246 a



Compressor	Model	Capacity	Displ.	Volt/freq.	Over load Protector	Re'ay	Motor type	Comp. Cooling
Gold star 1/6 hp	NR 52 LAEG	113 kcal/hr	5.2cc	220v/50Hz	Exteranal	PTC	RSIR	N

FOR MODEL 6247 a



Compressor	Model	Capacity	Displ.	Volt/freq.	Over load Protector	Relay	Motor type	Comp. Cooling
Gold Star Necchil/6hp	NR58 LAEG	124 Kcal/hr 130 " "	5.8 cc 7 cc	220 V/50HZ "	External "	PTC "	RSIR "	N "

For Model 6243 a



Compressor	Model	Capacity	Displ.	Volt/freq.	Over load Protector	Relay	Motor type	Comp. Cooling
GOLD STAR 1/8 hp	NR 45 LAEG	85Kcal/hr	4.50cc	220v/50Hz	External	PTC	PSRI	N

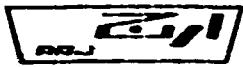

ARJ CORPORATION شرکت ارج آسانسورها

FOR MODEL 6202 a



Compressor	Model	Capacity	Displ.	Volt/freq.	Over load Protector	Relay	Motor type	Comp. Cooling
Gold star 1/4 hp	V 75 LAEG	167 Kcal/hr	7.46 cc	220V/50Hz	External	PTC	ESIR	OC

FOR MODEL 6249 a



Compressor	Model	Capacity	Displ.	Volt/freq.	Over load protecto	Relay	Motor type	Comp. Cooling
Necchi 1/4 hp	Esc9Hk	184 Kcal/hr	9.07cc	220v/50Hz	External	PTC	ESIR	OC



CONDENSER SPECIFICATIONS

FOR MODEL 6246 a
«»«»«»«»«»«»«»«»

Condenser	Type	No. of leg Dia.	Wide	Length	Volume
= 3/16"	static wired	18 - 3/16"	455.76mm	882 mm	86.1 cm3

FOR MODEL 6247a
«»«»«»«»«»«»«»«»

Condenser	Type	No. of leg Dia.	Wide	Length	Volume
= 3/16"	static wired	18 - 3/16"	455.76mm	882 mm	86.1 cm3

FOR MODEL 6243a
«»«»«»«»«»«»«»«»

Condenser	Type	No. of leg Dia.	Wide	Length	Volume
= 3/16"	static wired	14-3/16"	455.76mm	674	67.4

FOR MODEL 6202a
«»«»«»«»«»«»«»«»

Condenser	Type	No. of leg Dia.	Wide	Length	Volume
= 1/4 "	static wired	16+8-1/4 "	537.35mm	1188mm	326.7cm3

FOR MODEL 6249A
«»«»«»«»«»«»«»«»

Condenser	Type	No. of leg Dia.	Wide	Length	Volume
= 1/4 "	static wired	20+4-1/4 "	537.35mm	1188mm	326.7cm3



CAPILLARY SPECIFICATION

FOR MODEL 6246A



Capillary	Type	Length	Dryer	Thermostat	type
Q = 0.79mm	tube	3658mm	XH7-7.5gr	RANCO	k60-P1076

FOR MODEL 6247a



Capillary	Type	Length	Dryer	Thermostat	type
Q= 0.79mm	tube	3658mm	XH7-7.5gr	RANCO	K60-P1076

FOR MODEL 6243a



Capillary	Type	Length	Dryer	Thermostat	type
Q= 0.79mm	tube	3658mm	XH7-7.5gr	RANCO	k60-A076

FOR MODEL 6202a



Capillary	Type	Length	Dryer	Thermostat	type
Q= 0.79mm	tube	3048mm	XH7.10gr	RANCO	K50-P1397

FOR MODEL 6249a



Capillary	Type	Length	Dryer	Thermostat	type
Q= 0.79mm	tube	3048mm	XH7-10gr	RANCO	K59P4908

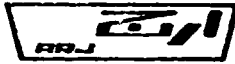

EVAPORATOR SPECIFICATION

FOR MODEL 6246a



Evaporator	Type	Wide	Length	Thickness	Volume
Alkan	Roll bond	308mm	1315mm	1.5mm	+ 210-x10cm ³

FOR MODEL 6247a



Evaporator	Type	Wide	Length	Thickness	Volume
Alkan	Roll bond	358.7mm	1315mm	1.5mm	+ 234-x10cm ³

FOR MODEL 6243a



Evaporator	Type	Wide	Length	Thickness	Volume
C.G.A	Roll bond	257mm	1194.7mm	1.5mm	+ 170-x10cm ³

FOR MODEL 6202a



Evaporator	Type	Wide	Length	Thickness	Volume
Q = 1/4 "	Tube	-	1200cm	0.71mm	+ 550 cm ³

FOR MODEL 6249a



Evaporator	Type	Wide	Length	Thickness	Volume
Alkan	Tube - Roll bond	127mm	1281.1mm	1.5mm	+ 150-x10cm ³

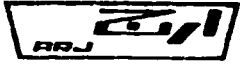

ARJ CORPORATION شرکت ارج سبز

MODEL 6246a



CALCULATION AND EQUIPMENT SELECTION FOR MODEL 6246a

TRANSMISSION LOAD

Qt = U * A * DT
C = U * A Cabinat constant "C"

Determination of the cabinat constant "C"

Conditions :

- * The refrigerator is standing in the air conditioned room at (ta)
* Installation of electrical heater of (P) inside the refrigerator cabinat for getting inside temperature (t1)
* The difference (t1-ta) should be between 15 to 20 c

Cabinat constant "C" : C = P / (t1-ta)

C = 21 / 15 = 1.43

The practical overall heat transfer coefficient (K) can be found from C as follow :

K = C / A units for C in W/K and A in m^2 effective heat transmission area

Simple derivation for seperate cabinat constant of freezer compartment and refrigerator compartment (cooling compartment enclosing celler compartment) can be found as follows :

C1 = K * A1

C2 = K * A2

A1 : effective heat transfer area of two stars freezer compatment.



ARJ CORPORATION

شركة ارج س.ج.ع

A2 : effective heat transfer area of cooling compartment enclosing
celler compartment

Calculatin of transmission heat

$$Q_t = Q_{t1} + Q_{t2}$$

$$Q_{t1} = C_1 * DT_1$$

$$Q_{t2} = C_2 * DT_2$$

Q_{t1} = Transmission heat relative to two stars freezer compartment

Q_{t2} = Transmission heat relative to cooling compartment enclosing
celler compartment.

$$T_1 = t_a - t_{i1}$$

$$T_2 = t_a - t_{i2}$$

$$t_{i1} = -12^{\circ}c$$

$$t_{i2} = +5^{\circ}c$$

$$t_a = +43^{\circ}c$$

A_{fo} = Outside area of the freezer compartment

$$A_{fo} = 2A_{3e} + A_1 + 2A_{2e} = 10904 \text{ cm}^2$$

A_{fi} = Inside area of the freezer compartment

$$A_{fi} = 2(28 \times 52.5) + (46 \times 52.5) + (28 \times 46) = 7142 \text{ cm}^2$$

A_{ro} = Outside area of the refrigerator compartment

$$A_{ro} = 2(61 \times 93) + 2(56 \times 93) + (61 \times 56) = 25178 \text{ cm}^2$$

A_{ri} = inside area of the refrigerator compartment

$$A_{ri} = 2(52.5 \times 89) + 2(46 \times 89) + (52.5 \times 46) = 19948 \text{ cm}^2$$



$$\begin{aligned}A_m &= \sqrt{A_i * A_o} \\A_{mf} &= 10904 \times 7143 = 0.8825 \text{ m}^2 \\A_{mr} &= 25178 \times 19948 = 2.241 \text{ m}^2 \\A &= 0.8825 + 2.241 = 3.1235 \text{ m}^2 \\U &= 1.43 / 3.1235 = 0.4578 \text{ w/m}^2 \text{ k} \\Q_{tr} &= U * A * DT \\Q_{tr} &= 0.4578 \times 2 \times 2.241 \times 38 \\Q_{tr} &= 38.98 \text{ watt} \\Q_{tf} &= 0.4578 \times 0.8825 \times 55 \\Q_{tf} &= 22.22 \text{ watt} \\Q_t &= 61.20 \text{ watt}\end{aligned}$$

PRODUCTION LOAD

$$Q_{pd} = \sum Q_{pr} + \sum Q_{pf} + \sum Q_{1f} + \sum Q_{1k}$$

Where

Q_{pr} = Heat removed from products above freezing point.

$$Q_{pr} = W * C_p * DT$$

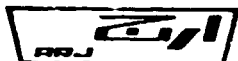

ARJ CORPORATION

شرکت آر جی

No.	Product	Specific heat	Weight Kg	Initial Temp. °C	Final Temp. °C
1	Meat	3.14	5	28	5
2	Butler	2.68	2	10	5
3	Vegetable	3.77	4	20	10
4	Fruit	3.81	5	20	10
5	Water	4.18	2	20	10
6	Milk	3.76	2	10	5

$$Q_{pr1} = 5 \times 3.14 (28-5) = 361 \text{ Kj}$$

$$Q_{pr2} = 2 \times 2.68 (10-5) = 26.8 \text{ ''}$$

$$Q_{pr3} = 4 \times 3.77 (20-10) = 150.8 \text{ ''}$$

$$Q_{pr4} = 5 \times 3.81 (20-10) = 190.5 \text{ ''}$$

$$Q_{pr5} = 2 \times 4 (20-10) = 80 \text{ ''}$$

$$Q_{pr6} = 2 \times 3.76 (10-5) = 37.6 \text{ ''}$$

$$Q_{pr} = 847 \text{ Kj}$$

For the Freezer part of Refrigerator

$$Q_{pf} = W * C_p * DT$$

Where

Q_{pf} = Heat removed from products to freezer product from initial temperature to freezing point

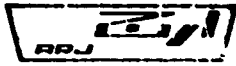

Product	Weight	Inlet Temp.	Freezing Point	Cp befor freezing	Cp after freezing
Fish	2 Kg	10 °c	-2.25 °c	3.18 kj/kg °k	1.72 kj/kg °k
Meat	2 kg	28 °c	-0.5 °c	3.14 kj/kg °k	1.67 kj/kg °k

$$Q_{pf1} = 2 \times 3.18 [10 - (-2.25)] = 77.91 \text{ Kj}$$

$$Q_{pf2} = 2 \times 3.14 [28 - (-0.5)] = 178.98 \text{ //}$$

$$Q_{pf} = 256.89 \text{ Kj}$$

$$Q_{lf} = w \times h_i$$

Where

Q_{lf} = Heat removed to freezer product .

$$Q_{lf1} = 2 \times 1.72 [-2.25 - (-12)] = 33.54 \text{ Kj}$$

$$Q_{lf2} = 2 \times 1.67 [-0.5 - (-12)] = 38.41 \text{ kj}$$

$$Q_{lf} = Q_{lf1} + Q_{lf2} \text{ kj}$$

$$Q_{lf} = 71.95 \text{ kj}$$

Q_{lf} = Heat removed to freeze product

$$Q_{lf} = W \times h_i$$

h_i = Latent heat per Kj/kg

$$h_{i1} = 235 \text{ kj/kg Fish}$$

$$h_{i2} = 228 \text{ " Meat}$$

$$Q_{lf} = Q_{lf1} + Q_{lf2}$$

$$Q_{lf} = 926 \text{ Kj}$$

Q_{lk} = Heat removed of 1 kg water for ice making from 10 °c to -12 °c



$$W = 1 \text{ kg}$$

$$C_p = 4.18 \text{ kJ/kg}^\circ\text{K}$$

$$Q_{1k1} = 1 \times 41.8 \quad (10-0)$$

$$Q_{1k1} = 41.8 \text{ kJ}$$

Q_{1k2} = Heat removed to freezer water

$$Q_{1k2} = W \times h_i$$

$$W = 1 \text{ kg}$$

$$h_i = 336 \text{ Latent heat of fusion}$$

$$Q_{1k2} = 336 \text{ kJ}$$

Q_{1k3} = Heat removed from freeze water to -12°C Evap.Temp.

$$Q_{1k3} = W \times C_p \times \Delta T.$$

$$W = 1 \text{ kg}$$

$$C_p = 2.09 \text{ kJ/kg}^\circ\text{K}$$

$$Q_{1k3} = 1 \times 2.09 \times 12 = 25.08 \text{ kJ}$$

$$Q_{1k} = Q_{1k1} + Q_{1k2} + Q_{1k3}$$

$$Q_{1k} = 41.8 + 336 + 25.08$$

$$Q_{1k} = 402.88 \text{ kJ}$$

Therefore the total production load will be :

$$zQ_{pd} = 847 + 256.89 + 71.95 + 926 = 402.78$$

$$zQ_{pd} = 2504.72 \text{ kJ}$$

$$2504.72 / 16 \times 3600 = 0.04348 \text{ kW}$$

$$Q_c = Q_t + Q_{pd}$$

$$Q_c = 61.44 + 43.48 = 104.92 \text{ watt}$$

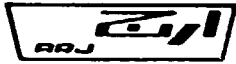

For air charging load (door opening) 10 % is taken

$$Q_a = 104.92 * 0.1 = 10.49 \text{ watt}$$

So cooling capacity will be :

$$Q_{cc} = Q_t + Q_{pd} + Q_a$$

$$Q_{cc} = 115.91 \text{ watt}$$

CONDENSER'S POWER DETERMINATION

We know that

$$K_s = \frac{S \text{ (k cal/h)} \times 1.25}{DT}$$

Where

K_s = Coefficient of transmission

S = Compressor cooling capacity

DT = The difference temperature of feron and embinet temperature

Operational condition

$$a) K_s = 115.41 \times 0.8605 \times 1.25 / 55 - 43 = 10.34 \text{ Kcal/h}$$

$$b) K_s = 115.41 \times 0.8605 \times 1.25 / 55 - 32 = 5.30 \text{ Kcal/h}$$

According to the static wired condenser, series 40-51-476

The suitable condenser dimensions is taken (see page 208)

No of legs : 18

The wide of the condenser : 466 mm

The length of the condenser : 876 mm

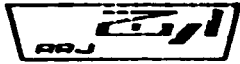

CAPILLARY'S CAPACITY DETERMINATION

According to the molier diagraph for R134a at an evaporation temperature of -23.3°C and absolute pressure of 1.167 the specific volume would be as follow (see page 203)

Liquid = .7305 L/kg

Vapour = 0.171 m3/kg

So we know that

Va = 2.35 * sqrt((2 / (p - 1)) * a^2.5 - 0.5 * L)

P = 14.90 condensation pressure at 55 c (see page 205)

Assuming mass flow rate 3.19 Kg/h of R134a

a = 0.79 mm capillary inside diameter mm

L = Capillary length

Va = 3.19 x 0.168 x 1000/60 = 9.09 L/min

So, applies the above formula

8.12 = 2.35 * sqrt((2 / (14.9 - 1)) * 0.79^2.5 - 0.5 * L)

L = 4.54 meter

Due to experience it should be 3 to 4 meter. However this value should be confirmed by adequate laboratory tests.



EVAPORATOR'S DETERMINATION

We know that for Hermetic compressor

Qcc = Q ev

Where

Qcc = Cooling capacity of compressor

Qev = " " evaporator

We have

Qcc = U * A * DT

Qcc = 99.31 Kcal/hr

Therefore 99.31 = U * A * DT

U = Coefficient of heat transmission of evaporator w / m²

A = Surface area of evaporator m²

DT = Difference temperature between the evaporator and compartment k

1/U = 1/Fo + x/k + 1/Fi

Fo = Fi = convection coefficient of inside & outside surface body.

Fo = Fi = 9.37 w/m² k

X = 1.5mm evaporator Thickness

k = 209.4 w/m² k

By applying the above formula

1/U = 1/9.37 + 1.5/209.4 + 1/9.37

U = 4.7 w/m² k

Therefore the evaporator surface will be :

92.31 = A x 4.7 [(-23.3-(-12))]

A = 1.869 m²

Research & Development Laboratories

Performance Sheet

Continuous Run at 220 V

No. 1

Refrigerator (10 cu.ft)

Room 2		Station 4		Date		March 95			
Test No. 1021		Model 6246a		Ambient °C		43			
Compressor NR 52 LAEG		Thermostat: Ranco		Control: Pes.		MAX. (Short)			
Overload -		Charge R 134a 142 gr		Kwhr Per Day		2	8	8	0
Remarks: Compressor Gold Star - 1/6 hp				Avg. Cas. Air °C		-13.9 / 0.26			
				Percent Run		1	0	0	%
				Average Watts		1	2	0	
				Cycles Per Day					
				Section C.I.					
				Pressure C.O.					
				Discharge Press.					
				Barometer		663 mmHg			

Actual Clock Time	Elapsed Time	Stopping Time Clock	Running Time	Kwhr Meter	Kwhr/Elapsed Time
9	2	1951	2:00	2137	
7		6:01		1897	240

Time											AVG.
Evaporator	°C	-13.9									
Cabinet	T ₁	°C	-0.3								
	T ₂	°C	-0.2								
	T ₃	°C	-0.3								
Compressor Shell	°C	98.6									
Suction Line	°C	39.6									
Thermostat	°C	-20.4									
Evap. highest Point	°C										
Top Egg Shelf	°C										
Bottom Egg Shelf	°C										
Dairy	°C										
Crisper	°C										
Inlet-Evap.	°C	-18.4									
Outlet-Evap.	°C	-17.7									
Inlet-Cond.	°C	77									
Outlet-Cond.	°C	56									
Middle Point Cond.	°C										
Room	°C	43									

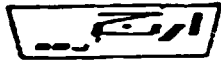

Research & Development Laboratories Performance Sheet

Refrigerator (10 cub.ft)

Continuous Run

No. 2

Room	2	Station	4	Date	March 95			
Test No.	1028	Model	9216a	Ambient °C	43			
Compressor	NR52 LAEG	Thermostat	Ranco	Control Pos.	Max (short)			
Overload		Charge	R134a -120 gr	kwhr Per Day	2	9	0	4
Remarks: Compressor Gold star - 1/6 hp				Avg. Cab. Air °C	-13.2 / 0.2			
				Percent Run	1	0	0	5
				Average Watts	1	2	1	
				Cycles Per Day				
				Suction °C				
				Pressure °C				
				Discharge Press-				
				Barometer	658 mm Hg			
Actual Clock Time	Elapsed Time	Running Time Clock	Running Time	kwhr Meter	kwhr/Elapsed Time			
12	2	810	200	3139	244			
10		610		2895				

Time											AVG.
EVAPORATOR	°C	-13.2									
CABINET	T.	°C	0.30								
	T.	°C	0.10								
	T.	°C	0.20								
Compressor Shell	°C	99									
Suction Line	°C	40.2									
Thermostat	°C										
Evap. highest Point	°C										
Top Egg Shelf	°C										
Bottom Egg Shelf	°C										
Dairy	°C										
Crisper	°C										
Inlet-Evap.	°C	-18.1									
Outlet-Evap.	°C	-17.4									
Inlet-Cond.	°C	78									
Outlet-Cond.	°C	57									
Middle Point-Cond.	°C										
Room	°C	43									

Tested By :

Head of Research & Development

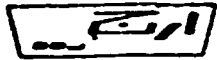

Research & Development Laboratories Performance Sheet

Refrigerators - 10 sub. (1)

Continuous Run

No. 3

Room 2	Station 2	Date	March 95	
Test No. 1208	Model 6246 a	Ambient °C	43	
Compressor NR52 LAEC	Thermostat Ranco	Control Pos.	Max (short)	
Overload	Charge R134a- 140gr	kwhr Per Day	2	9
Remarks: COMPRESSOR GOLD STAR 1/6 hp		Avg. Cab. Air °C	-13.15 / 0.15	
		Percent Run	1	0
		Average Watts	1	2
		Cycles Per Day		
		Section C.I.		
		Pressure C.O.		
		Discharge Press-		
		Barometer	656 mm Hg	

	Elapsed Time	Running Time	Kwhr Meter	Kwhr/Elapsed Time
11	2	967	1788	245
9		767	1543	

Time											AVG.
EVAPORATOR	°C	-13.5									
CABINET	T.	°C	0.30								
	T.	°C	0.15								
	T.	°C	0.22								
Compressor Shell	°C	100									
Suction Line	°C	41									
Thermostat	°C										
Evap. highest Point	°C										
Top Egg Shell	°C										
Bottom Egg Shell	°C										
Dairy	°C										
Crisper	°C										
Inlet-Evap.	°C	-18.1									
Outlet-Evap.	°C	-17.4									
Inlet-Cond.	°C	79									
Outlet-Cond.	°C	59									
Middle Point-Cond.	°C										
Room	°C	43									

Tested By :

Head of Research & Development



Research & Development Laboratories Performance Sheet

Refrigerator (10 cub. ft)

continuous Run

No. 4

Room 2	Station 3	Date	March 95																											
Test No. 1221	Model 6226 a	Ambient °C	43																											
Compressor NR 52 ALEG	Thermostat Ranco	Control Pos.	Max (short)																											
Overload	Charge R134a - 143 gr	kwhr Per Day	2	9 7 6																										
Remarks: Compressor Gold star - 1/6hp		Avg. Cab. Air °C	-13.1 / 0.23																											
<table border="1" style="width: 100%; border-collapse: collapse;"> <tr> <td style="width: 15%;"></td> <td style="width: 15%;"></td> <td style="width: 15%;"></td> <td style="width: 15%;"></td> <td style="width: 15%;"></td> <td style="width: 15%;"></td> </tr> <tr> <td>12</td> <td>2</td> <td>1223</td> <td>200</td> <td>5680</td> <td>248</td> </tr> <tr> <td>10</td> <td></td> <td>1023</td> <td></td> <td>5432</td> <td></td> </tr> <tr> <td>Actual Clock Time</td> <td>Elapsed Time</td> <td>Running Time Clock</td> <td>Running Time</td> <td>Kwhr Meter</td> <td>Kwhr/Elapsed Time</td> </tr> </table>								12	2	1223	200	5680	248	10		1023		5432		Actual Clock Time	Elapsed Time	Running Time Clock	Running Time	Kwhr Meter	Kwhr/Elapsed Time	Percent Run	1	0	0	%
		12	2	1223	200	5680	248																							
		10		1023		5432																								
		Actual Clock Time	Elapsed Time	Running Time Clock	Running Time	Kwhr Meter	Kwhr/Elapsed Time																							
		Average Watts	1	2	4																									
		Cycles Per Day																												
		Section C.I																												
		Pressure C.O.																												
		Discharge Press.																												
Barometer	658 mm Hg																													

Time											AVG.
EVAPORATOR	°C	13.1									
CABINET	T.	°C	0.23								
	T.	°C	0.18								
	T.	°C	0.22								
Compressor Shell	°C	101									
Suction Line	°C	42									
Thermostat	°C										
Evap. highest Point	°C										
Top Egg Shell	°C										
Bottom Egg Shell	°C										
Dairy	°C										
Crisper	°C										
Inlet-Evap.	°C	-18									
Outlet-Evap.	°C	-17.3									
Inlet-Cond.	°C	80									
Outlet-Cond.	°C	62									
Middle Point-Cond.	°C	-									
Room	°C	43									

Tested By: ..

Head of Research & Development

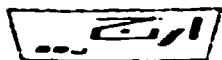

Research & Development Laboratories Performance Sheet

No. 5

REFRIGERATOR (10cJ.ft.)

Continuous Run

Room 2	Station 1	Date	Sept. 1995	
Test No. 1073	Model 6246a	Ambient °C	32	
Compressor NR52 LAEG	Thermostat Ranco	Control Pos.	Shut	
Overload	Charge R134a 142gr.	kwhr Per Day	2	0
Remarks: COMPRESSOR GOLD STAR 1/6hp		Avg. Cab. Air °C	-15.2/-4.9	
		Percent Run	1	0
		Average Watts	1	1
		Cycles Per Day		
		Suction C.I.		
		Pressure C.O.		
		Discharge Press.		
		Barometer	658 mm Hg	

9	2	3161h	200	7849h	220
7	Elapsed Time	3161h	Running Time	78270	kwhr/Elapsed Time
	Actual Clock Time	Running Time Clock		kwhr Meter	

Time		°C	-15.2						AVG.
EVAPURATOR		°C	-15.2						
Cabinet	T.	°C	-4.8						
	T.	°C	-5						
	T.	°C	-5.1						
Compressor Shell		°C	83.4						
Suction Line		°C	29						
Thermostat		°C	-20.4						
Evap. highest Point		°C							
Top Egg Shell		°C							
Bottom Egg Shell		°C							
Dairy		°C							
Crisper		°C							
Inlet-Evap.		°C	-20.1						
Outlet-Evap.		°C	-21.4						
Inlet-Cond.		°C	64						
Outlet-Cond.		°C	43.5						
Middle Point-Cond.		°C							
Room		°C	32						
		°C							
		°C							
		°C							
		°C							
		°C							
		°C							
		°C							
		°C							
		°C							
		°C							
		°C							
		°C							
		°C							

Tested By

Head of Research & Development

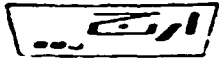

Research & Development Laboratories Performance Sheet

REFRIGERATOR (10cu.ft)

Continuous Run

No.6

Room 7	Station 1	Date	Sept. 1995	
Test No. 1094	Model 6246 a	Ambient °C	18	
Compressor NR52	Thermostat Danfoss	Control Pos.	Short	
Overload	Charge R134a 142gr	kwhr Per Day	2	4
Remarks: Compressor Gold Star 1/6hp.		Avg. Cap. Air °C	-17.5 / -5.9	
		Percent Run	1	0
		Average Watts	1	0
		Cycles Per Day		
		Suction C.I.		
		Pressure C.O.		
		Discharge Press.		
		Bgrometer		

10	2	65802	200	65012	202		
7	Elapsed Time	Running Time Clock	Running Time	Kwhr Meter	Kwhr/Elapsed Time		

Time	°C	-17.5						AVG.
Evaporator	°C	-17.5						
Cabinet	T ₁	°C	-5.3					
	T ₂	°C	-6					
	T ₃	°C	-6.2					
Compressor Shell	°C	74						
Suction Line	°C	16						
Thermostat	°C	-22.2						
Evap. highest Point	°C							
Top Egg Shelf	°C							
Bottom Egg Shelf	°C							
Dairy	°C							
Crisper	°C							
Inlet-Evap.	°C	-22.9						
Outlet-Evap.	°C	-21.1						
Inlet-Cond.	°C	58						
Outlet-Cond.	°C	24						
Middle Point-Cond.	°C							
Room	°C	18						

Tested By :

Head of Research & Development

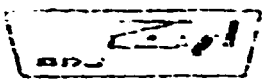

Research & Development Laboratories

No. 1

TEST: Full down	TEST No. 1022	DATE: March 95
VOLTS: 220 CYC. 50Hz	MODEL No. 6246a	ROOM: 2 STA.
CHARGE: R134a -142 gr	COMP No.	AMBIENT: 43°C

OVERLOAD

ISOLATOR + LEADS

Re:

Te:

ISO. No.

Time	0	10Min	25	60	120	180					
AMPS.		1.2	0.95	0.92	0.85	0.76					
WATTS		2.05	170	160	140	132					
Suct. Pressure											
Evaporator °C	43	31.6	12.8	-1.1	-6.7	-9.4					
Cabinet	T ₁ °C	43	41.4	37.3	26	14.6	8.6				
	T ₂ °C	43	41.1	36.2	24	13.4	5.7				
	T ₃ °C	43	40.2	35	23.7	12.6	6.7				
Compressor Shell °C	43	60	79	97	101	100					
Suction Line °C	43	53	45	45.5	41	40					
Thermostat °C	43	-2.2	-9.5	-12.2	-16	-17.2					
Inlet Evap. °C	43	1.5	-6.9	-10.4	-14.9	-16.1					
Outlet Evap. °C	43	5.2	-11.5	-14.5	-18	-19.6					
Inlet Cond. °C	43	76	78	84	81	78.5					
Outlet Cond. °C	43	69	62	61	58	60					
Room °C	43	43	43	43	43	43					

COMPLETION TIME--180 Mins.

No. OF CUT-OUTS----- TOTAL OFF TIME-----

me											
AMPS.											
WATTS											
Suct. Pressure											
P.C.											
P.C.	T ₁ °C										
	T ₂ °C										
	T ₃ °C										
Compressor Shell °C											
Suction Line °C											
Ice Tray °C											
Welding °C											
Bridge 2											
Room °C											

Tested by

-35-

Head of Research & Development

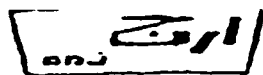

TEST: PULL DOWN	TEST No. 1201	DATE: MARCH 95
VOLTS: 220 CYC. 50 Hz	MODEL No. 6246 a	ROOM: 1 STA. 3
CHARGE: R134a-145 gr	COMP No.	AMBIENT: 43 C

OVERLOAD :

ISOLATOR ÷ LEADS :

Ro :

To :

ISO . No.

Time	0 Min	10	25	60	120	180							
AMPS.		1.24	0.98	0.95	0.88	0.80							
WATTS		209	171	160	142	135							
Suct. Pressure													
EVAPORATOR °C	43	31	12.2	-1.5	-6.2	-9.1							
T. °C	43	41	37.1	27	14.1	8.7							
CABINET T. °C	43	41.2	37.3	26	13.8	5.8							
T. °C	43	40.1	36.9	24	12.5	6.6							
Compressor Shell °C	43	61	79	98	101	102							
Suction Line °C	43	53	45	46.5	42	41							
THERMOSTAT °C	43	-2.3	-8.9	-11.7	-14.8	-15.9							
INLET EVAP. °C	43	-7.4	-10.9	-14.6	-16.1	-18.5							
OUTLET EVAP.	43	-8	-11.1	-14.9	-16.7	-19.2							
INLET COND °C	43	76	78	84	82	80							
OUTLET COND °C	43	69	62	60	59	61							
Room °C													

COMPLETION TIME 180 Min

No. OF CUT-OUTS _____ TOTAL OFF TIME _____

me													
AMPS.													
WATTS													
Suct. Pressure													
F. C. °C													
P.C.	T. °C												
	T. °C												
	T. °C												
Compressor Shell °C													
Suction Line °C													
Ice Tray °C													
Welding °C													
Bridge 2													
Room °C													

Tested by

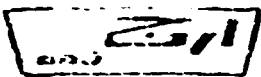

Research & Development Laboratories

No. 3

TEST : FULL DOWN			TEST No. 1043				DATE : MARCH 95				
VOLTS : 220 CYC. 50Hz			MODEL No.				ROOM : 3 STA. 1				
CHARGE : R134 a -140gr			COMP No. 6246 a				AMBIENT : 43 C				
OVERLOAD :											
ISOLATOR ÷ LEADS :											
		Ro :			To :			ISO . No.			
Time	0 Min	10	25	60	120	185					
AMPS.		1.23	0.96	0.86	0.86	0.78					
WATTS		207	171	159	141	134					
Suct. Pressure											
CABINET	T ₁ °C	43	30.9	12.2	-1.01	-6.2	-9.2				
	T ₂ °C	43	40.8	36.2	25	13.9	8.5				
	T ₃ °C	43	40.6	35.8	23	13.1	5.6				
	T ₄ °C	43	39.9	34	23.2	12.1	6.5				
Compressor Shell °C	43	58	78	96	700	99					
Suction Line °C	43	51	43	44.5	40	39					
THERMOSTAT °C	43	-2.1	-9	-12	-15	-16.5					
INLET EVAP. °C	43	1.4	-6.7	-10.0	-14.7	-15.9					
OUTLET EVAP. °C	43	5.1	-11.2	-14.4	-17	-19					
INLET COND °C	43	75	76	82	80	77.5					
OUTLET COND °C	43	68	61	59	57	59					
INLET OC											
OUTLET OC											
Room °C											

COMPLETION TIME 185 Min No. OF CUT-OUTS TOTAL OFF TIME

me											
AMPS.											
WATTS											
Suct. Pressure											
F. C. °C											
P.C.	T ₁ °C										
	T ₂ °C										
	T ₃ °C										
Compressor Shell °C											
Suction Line °C											
Ice Tray °C											
Winding °C											
Bridge 2											
Room °C											

Tested by

Head of Research & Development

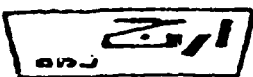

Research & Development Laboratories

No. 4

TEST: PULLDOWN	TEST No. 1143	DATE: MARCH 95
VOLTS: 220 CYC. 50Hz	MODEL No. 6246a	ROOM: 2 STA. 2
CHARGE: R134a - 143gr	COMP No.	AMBIENT: 43C

OVERLOAD :

ISOLATOR ÷ LEADS :		No :						To :						ISO . No.						
Time	0 Min	10	25	60	120	188														
AMPS.		1.09	95	0.94	0.85	0.79														
WATTS		205	170	160	142	135														
Suct. Pressure																				
EVAPORATOR °C	43	31	12.1	-1	-6.1	-9.3														
T ₁ °C	43	40.7	36.1	27	13.2	8.6														
CABINET T ₁ °C	43	41.2	36.1	23	12.9	5.5														
T ₂ °C	43	40.1	33	22.9	11.9	6.6														
Compressor Shell °C	43	59	79	97	102	101														
Suction Line °C	43	52	45	46	42	40														
THERMOSTAT °C	43	-2.15	-10	-11.8	-14.1	-16.6														
INLET EVAP. °C	43	1.2	-6.7	-10.1	-14.6	-16														
OUTLET EVAP.	43	5.1	-11.3	-14.3	-16.9	-19														
INLET COND °C	43	75	-77	82	81	78														
OUTLET COND °C	43	60	62	60	58	60														
Room °C																				

COMPLETION TIME 188 Min No. OF CUT-OUTS TOTAL OFF TIME

AMPS.																				
WATTS																				
Suct. Pressure																				
F. C. °C																				
P.C.	T ₁ °C																			
	T ₂ °C																			
	T ₃ °C																			
Compressor Shell °C																				
Suction Line °C																				
Ice Tray °C																				
Welding °C																				
Bridge	2																			
Room																				

Tested By

Head of Research & Development

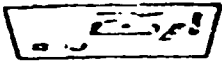

Research & Development Laboratories Performance Sheet

Refrigerator (10 cu.ft)

Cycling Run.

No.1

Room 1		Station 3		Date		March 95				
Test No. 1026		Model 6226a		Ambient °C		43				
Compressor NR 52 LAEG		Thermostat: Ranco		Control Pos.		MID.				
Overload		Charge R134a 142 gr		kwhr Per Day		2	4	1	2	
Remarks: Compressor Gold Star 1/6 hp						Avg. Cab. Air °C		-10 / 1.6		
						Percent Run		7	6	%
						Average Watts		1	0	1
						Cycles Per Day		48		
						Suction C.I.				
						Pressure C.O.				
						Discharge Press.				
						Barometer		658mm Hg		
10	2	170	152	861	201					
8		18		660						
Actual Clock Time	Elapsed Time	Running Time Clock	Running Time	kwhr Meter	kwhr/Elapsed Time					

Time	°C	Cut out	Cut in																AVG.
Evaporator	°C	-11	-9																
Cabinet	T ₁	°C	0.9	2.5															
	T ₂	°C	1.2	1.45															
	T ₃	°C	1.65	1.85															
Compressor Suel	°C	94	81																
Suction Line	°C	38	36																
Thermostat	°C	-19.9	-7.3																
Evap. highest Point	°C																		
Top Egg Shell	°C																		
Bottom Egg Shell	°C																		
Dairy	°C																		
Crisper	°C																		
Inlet-Evap.	°C	-18.5	-4.9																
Outlet-Evap.	°C	-21.7	-5.8																
Inlet-Cond.	°C	72.5	42																
Outlet-Cond.	°C	53.6	45.8																
Middle Part Cond.	°C																		
Room	°C	43	43																



Research & Development Laboratories Performance Sheet

Refrigerator (10 Cub. ft)

Cycling Run

No. 2

Room	2	Station	2	Date	March 95			
Test No.	1121	Model	6226 a	Ambient °C	43			
Compressor	NR52 LAEG	Thermostat	RANCO	Control Pos.	MID			
Overload		Charge	RI34a-140gr	kwhr Per Day	2	4	2	4
Remarks: Compressor Gold Star - 1/6 hp.				Avg. Cab. Air °C	-9.5/-1.5			
				Percent Run	7	7	%	
				Average Watts	1	6	1	
				Cycles Per Day	49			
				Section	C.I.			
				Pressure	C.O.			
				Discharge Press.				
				Barometer	658 mm Hg			
10	2	275	155	962	202			
8		120		760				
Actual Clock Time	Elapsed Time	Running Time Clock	Running Time	Kwhr Meter	Kwhr/Elapsed Time			

Time		Outout	Cut in								AVG.
EVAPORATOR	°C	-10.8	-9.8								
CABINET	T.	°C	0.90	2.5							
	T.	°C	1.20	1.40							
	T.	°C	1.60	1.80							
Compressor Shell	°C	95	82								
Suction Line	°C	37	37								
Thermostat	°C	-19.7	7.2								
Evap. highest Point	°C										
Top Egg Shell	°C										
Bottom Egg Shell	°C										
Dairy	°C										
Crisper	°C										
Inlet-Evap.	°C	-18.2	-4.7								
Outlet-Evap.	°C	-21.1	-5.7								
Inlet-Cond.	°C	73	43								
Outlet-Cond.	°C	54	46								
Middle Point-Cond.	°C										
Room	°C	43	43								

Tested By :

Spec of Research & Development

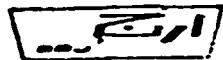

Research & Development Laboratories Performance Sheet

Refrigerator (10 cub.ft.)

Cycling Run

NO. 3

Room 1	Section 1	Date	March 95	
Test No. 1301	Model 5226a	Ambient °C	43	
Compressor NR52 LAEG	Thermostat Range	Control Pos.	MID	
Overload	Charge F134a 140gr	kwhr Per Day	2	4
Remarks: COMPRESSOR Gold star - 1/6 hp		Avg. Cab. Air °C	4	8
		Percent Run	7	7
		Average Watts	1	0
		Cycles Per Day	51	
		Section C.I.		
		Pressure C.O.		
		Discharge Press.		
		Barometer	658 mm Hg	

Time	Cutout	Cut in								AVG.
EVAPORATOR °C	-10.7	-9.7								
CABINET	T, °C	0.90	2.4							
	T, °C	7.28	1.41							
	T, °C	7.62	1.81							
Compressor Shell °C	95.5	82.5								
Suction Line °C	40	38								
Thermostat °C	-19.6	7								
Evap. highest Point °C										
Top Egg Shell °C										
Bottom Egg Shell °C										
Dairy °C										
Crisper °C										
Inlet-Evap. °C	-18.1	-4.5								
Outlet-Evap. °C	-21	-5.5								
Inlet-Cond. °C	74	45								
Outlet-Cond. °C	57	46								
Middle Point-Cond. °C	-	-								
Room °C	43	43								

Tested By :

Head of Research & Development

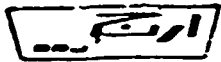

Research & Development Laboratories Performance Sheet

Refrigerator (10 cub ft.)

Cycling Run

No. -

Room	2	Station	2	Date	March 95			
Test No.	1421	Model	6243	Ambient °C	43			
Compressor	NR52 LAEG	Thermostat	Ranco	Control Pos.	MID			
Overload		Charge	R134a-143gr	kwhr Per Day	2	4	7	2
Remarks:	Compressor Gold star - 1/6 hp			Avg. Cab. Air °C	-10.5 / 2.22			
				Percent Run	7	0	%	
				Average Watts	1	0	3	
				Cycles Per Day	52			
				Section	C.I.			
				Pressure	C.O.			
				Discharge Press.				
				Barometer	658 mm Hg			

12	2	784	159	2332	205			
10		625		2127				
ACTUAL Clock Time	Elapsed Time	Running Time Clock	Running Time	Kwhr Meter	Kwhr/ Elapsed Time			

Time	°C	Cutout	Cut in							AVG.
EVAPORATOR	°C	10.5	-9.5							
CABINET	T ₁	°C	0.88	0.23						
	T ₂	°C	7.20	7.40						
	T ₃	°C	7.6	1.75						
Compressor Shell	°C	40	38							
Suction Line	°C	-19.5	-7							
Thermostat	°C									
Evap. highest Point	°C									
Top Egg Shell	°C									
Bottom Egg Shell	°C									
Dairy	°C									
Crisper	°C									
Inlet-Evap.	°C	-18	-42							
Outlet-Evap.	°C	-20	-5.1							
Inlet-Cond.	°C	76	46							
Outlet-Cond.	°C	59	47							
Middle Point-Cond.	°C									
Room	°C	42	43							

Tested By :



Prctotype No. 1

Ice Freeze Performance Sheet	
Model	6246a
Compressor Power	1/6 hp - NR52 LAEG
Ambient	32 °c
Thermostat position	Shorted
Volts /Amper	220 V/0.1.05A
Percentage working	Continous
Freezer air	-12.1 °c
Cabinet mean Temp.	4.9 °c
Compressor Sheet Temp.	97 °c
Inlet Cond Temp.	57 °c
Outlet Cond.Temp.	48 °c

Remarks : Within 4 hours Ice Temp. reached to -7°c

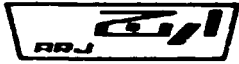

Prototype No. 2

Ice Freeze Performance Sheet	
Model	6246a
Compressor Power	1/6 hp - NR52 LAEG
Ambient	32 °c
Thermostat position	Shorted
Volts /Amper	220 V/ 1.06A
Percentage working	Continous
Freezer air	-12.1 °c
Cabinet mean Temp.	4.9 °c
Compressor Sheet Temp.	97 °c
Inlet Cond.Temp.	67 °c
Outlet Cond.Temp.	49 °c

Remarks : Within 4 hours & 2 minutes Ice Temp. reached to -7c



Prototype No. 3

Ice Freeze Performance Sheet	
Model	6246a
Compressor Power	1/6 hp - NR52 LAEG
Ambient	32 °c
Thermostat position	Shorted
Volts /Amper	220 V/ 1.06A
Percentage working	Continous
Freezer air	-12 °c
Cabinet mean Temp.	4.8 °c
Compressor Sheet Temp.	97 °c
Inlet Cond.Temp.	67 c
Outlet Cond.Temp.	49 °c

Remarks : Within 4 hours & 2 minutes Ice Temp. reached to -7°c



Prototype No. 4

Ice Freeze Performance Sheet	
Model	6246a
Compressor Power	1/6 hp - NR52 LAEG
Ambient	32 °c
Thermostat position	Shorted
Volts /Amper	220 V/0.1.05A
Percentage working	Contincous
Freezer air	-12 °c
Cabinet mean Temp.	4.8 °c
Compressor Sheet Temp.	98 °c
Inlet Cond.Temp.	68 °c
Outlet Cond.Temp.	49 °c

Remarks : Within 4 hours & 3 minutes Ice Temp. reached to -7 °c



ARJ CORPORATION شرکت ارج

MODEL 6247a



CALCULATION AND EQUIPMENT SELECTION FOR MODEL 6247a

TRANSMISSION LOAD

Qt = U * A * DT

C = U * A

Constant " C " = P / (t1-ta)

C = 21.1 / (35-20)

C = 1.4 w/k

C1 = K * A 1

C2 = K * A 2

A1 = Effective heat transfer area of freezer compartment.

A2 = " " " " " cooling " .

Therefore *****

Qt = Qt1 + Qts

Qt1 = C1 * DT1

Qt2 = C2 * DT2

Where *****

Qt1 = Transmission heat relative to freezer compartment .

Qt2 = " " " " " cooling " .

DT = ta - ti1

DT2 = ta - ti2

Where

$t_{i1} = -12 \text{ c}$ for two star refrigerator

$t_{i2} = 5 \text{ c}$ Average Temp. of inside cabinet

$t_a = 43 \text{ c}$ Ambient Temp.

A_{fo} = Out side area of the freezer compartment

$$A_{fo} = 2A_{3e} + A_1 + 2A_{2e}$$

$$A_{fo} = 12017 \text{ cm}^2$$

A_{fi} = Inside area of the freezer compartment.

$$A_{fi} = 2A'_{2e} + A'_1 + 2A'_{3e}$$

$$A_{fi} = 9063 \text{ cm}^2$$

A_{ro} = Out side area of the refrigerator compartment

$$A_{ro} = 2A_{2r} + A_1 + 2A_{3r}$$

$$A_{ro} = 33794 \text{ cm}^2$$

A_{ri} = Inside area of the refrigeration compartment.

$$A_{ri} = 2A'_{2r} + A'_1 + 2A'_{3r}$$

$$A_{ri} = 25582 \text{ cm}^2$$

$$A_{ri} = \sqrt{A_i \cdot A_o} \quad \text{mean value}$$

$A_{mf} = 1.043$ for freezer compartment

$A_{mr} = 2.940$ for refrigerator compartment

$$A = A_{mf} + A_{mr}$$

$$A = 3.983 \text{ m}^2$$

$$U = 1.40 / 3.983 = 0.351 \text{ w/m}^2 \text{ k}$$



$$Q_{tr} = U * A * DT$$

$$Q_{tr} = 0.351 \times 2.94 \times 38 \text{ for refrigerator compartment}$$

$$Q_{tr} = 39.21 \text{ watt}$$

$$Q_{tf} = 0.351 \times 1.043 \times 55 \text{ for freezer compartment}$$

$$Q_{tf} = 27.60 \text{ watt}$$

$$Q_t = Q_{tr} + Q_{tf}$$

$$Q_t = 66.81 \text{ watt}$$

PRODUCTION LOAD

$$Q_{pd} = \sum Q_{pr} + \sum Q_{pf} + \sum Q_{if} + \sum Q_{lk}$$

Where

Q_{pr} = Heat removed from products above freezing point

No.	Product	Specific heat	Weight	Initial Temp.	Final Temp.
1	Meat	3.14 kJ/kg °k	6 kg	28 °c	5 °c
2	Butter	2.68	2.5	10	5
3	Vegetable	3.77	5	20	10
4	Fruit	3.81	6	20	10
5	Water	4.18	2.5	20	10
6	Milk	3.76	2	10	5

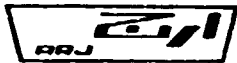

Therefore

$$Q_{pr1} = 6 \times 3.14 (28-5) = 433.32 \text{ kj}$$

$$Q_{pr2} = 2.5 \times 2.68 (10-5) = 33.50 \text{ ''}$$

$$Q_{pr3} = 5 \times 3.77 (15-5) = 198.50 \text{ ''}$$

$$Q_{pr4} = 6 \times 3.91 (15-5) = 228.60 \text{ ''}$$

$$Q_{pr5} = 2.5 \times 4.18 (20-10) = 50 \text{ ''}$$

$$Q_{pr6} = 2 \times 3.76 (10-5) = 37.60 \text{ ''}$$

$$Q_{pr} = 971.5 \text{ Kj} \text{ ''}$$

For the freezer part of refrigerator

Q_{pf} = Heat removed of product from initial Temp. to freezing point.

$$Q_{1f} = W * C_p * DT$$

Product	Weight	Initial Temp.	Freezing point	C_p befor freezing	C_p after freezing
Fish	2	10 °c	-2.25 °c	3.18 kj/kg	1.72 kj/kg
Meat	3	28	-0.5	3.14 "	1.67 "

Therefore

$$Q_{pf1} = 77.91 \text{ kj for Fish}$$

$$Q_{pf2} = 268.47 \text{ kj for Meat}$$

$$Q_{pf} = Q_{pf1} + Q_{pf2}$$

$$Q_{pf} = 346.38 \text{ kj}$$

Q_{1f} = Heat removed from freezing point to -12 °c

$$Q_{1f} = W * C_p * DT$$

$$Q_{1f1} = 2 \times 1.72 [-2.25 - (-12)] = 33.54 \text{ kj}$$

$$Q_{1f2} = 3 \times 1.67 (-0.5 - (-12)) = 57.61 \text{ kj}$$

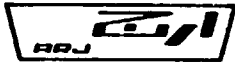

$$Q_{lf} = 91.15 \text{ kj}$$

Q_{lf} = Heat removed to freeze product

$$Q_{lf} = W * h_i$$

h_i = Latent heat for kj/kg

h_{i1} = 235 kj /kg Fish latent heat

h_{i2} = 228 kj/kg Meat latent heat

$$Q_{lf} = Q_{lf1} + Q_{lf2}$$

$$Q_{lf} = 476 + 684$$

$$Q_{lf} = 1154 \text{ kj}$$

Q_{lf} = Heat removed of 1 kg water for ice making from 10 °c to -12 °c

Q_{lk} = 402.88 kj (as it is calculated) for model 6246a

So, Total production load will be :

$$zQ_{pd} = 1026 + 346.30 + 91.15 + 1154 + 402.88$$

$$zQ_{pd} = 3020.35 \text{ kj}$$

$$Q_{pd} = 52.43 \text{ watt}$$

sum of transmission and production load

$$Q_c = Q_t + Q_{pd}$$

$$Q_c = 66.81 + 52.43$$

$$Q_c = 119.24 \text{ watt}$$

For air changing load 10% is taken

$$Q_a = 11.83 \text{ watt}$$

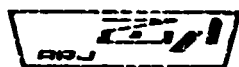

Therefore cooling capacity will be :

$$Q_{cc} = Q_t + Q_{pd} + Q_a$$

$$Q_{cc} = 131.16 \text{ watt}$$

CONDENSER,S POWER DETERMINATION

We know that

$$K_s = \frac{s(\text{Kcal/h}) \times 1.25}{DT}$$

Where

Ks = Coefficient of transmission

s = Compressor cooling capacity

DT = The difference of freon and ambient temperature

Operational condition

$$a) \quad K_s = 131.16 \times 0.8605 \times 1.25 / 55-43 = 11.75 \text{ Kcal/hk}$$

$$b) \quad K_s = 131.16 \times 0.8605 \times 1.25 / 55-32 = 11.13 \text{ Kcal/hk}$$

According to static wired condenser, series 40-51-476 (see page 208)

The suitable condenser dimension is taken

No of legs : 18

The wide of the condenser : 465 mm

The length of the condenser : 365 mm



CAPILLARY,S CAPACITY DETERMINATION

According to the mollier diagrafe for R134a at an evaporation Temp.-23.3 °c and absolute pressure of 1.167 bar the specific volume would be as follow (see page 203)

Liquid = 0.7305 l/kg
Vapour = 0.171 m3/kg

We know that

Va = 2.35 * sqrt(2 / (p - 1)) * a^2.5 * L^-0.5

Where

P = 14.90 kg/cm^2 at 55 c condensation pressure (see page 205)

a = 0.79 mm capillary inside diameter

L = length of capillary tube

Assuming mass flow rate 2.90 kg/h of R134a

Va = 2.90 x 0.171 x 1000/60 = 8.26 l/min

So by appling the above formula

8.12 = 2.35 * sqrt(2 / (14.90 - 1)) * 0.79^2.5 * L^-0.5

L = 5.50 meter

EVAPORATOR,S DETERMINATION

We know that for hermatic compressor

Qcc = Qev

Where

Qcc = Cooling capacity of compressor

Qev = 118.3 cooling capacity of evaporator Kcal/hr



We have

$$Q_{cc} = U * A * \Delta t$$

U = Coefficient of heat transmission of evaporator $w/m^2 k$

A = Surface area of evaporator m^2

Δt = Difference Temp. between evaporating Temp. and compartment $^{\circ}k$

$$1/U = 1/f_o + x/k + 1/f_i$$

$f_o = f_i = 9.37 w/m^2 k$ conductance factor of inside and outside body

x = 1.5 mm evaporator thickness

k = 209.4 $w/m^{\circ}k$ thermal conductivity of aluminium

By applying the above formulae

$$1/U = 1/9.37 + 105/209.4 + 1/9.37$$

$$U = 4.7 w/m^2 k$$

Therefore

$$112.86 = A * 4.7 * 11.3$$

$$A = 21.12 m^2$$

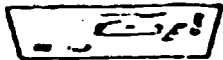

Research & Development Laboratories

Performance Sheet- Continuous Run at 220 V

Refrigerator (12 cu.ft)

No. 1

Room 2	Station 3	Date	March 95	
Test No. 1027	Model 6247a	Ambient °C	43	
Compressor E SC 7H	Thermostat Ranco	Control Pos.	MAX. Short	
Overload	Charge R134a 155 gr	kwhr Per Day	3	3
Remarks: Compressor Necchi - 1 1/2 hp		Avg. Cab. Air °C	6	0
		Percent Run	1	0
		Average Watts	1	4
		Cycles Per Day	0	0
		Suction C.I.		
		Pressure C.O.		
		Discharge Press.		
		Barometer	660 mm Hg	
12	2	12:10	2:00	587
10		10:10		307
Actual Clock Time	Elapsed Time	Stopping Time Clock	Running Time	kwhr/Elasped Time

Time																		AVG.
Evaporator	°C	-14.5																
Cabinet	T ₁	°C	2															
	T ₂	°C	4															
	T ₃	°C	3.5															
Compressor Shell	°C	95.5																
Suction line	°C	30.5																
Thermostat	°C	-19																
Evap. Highest Point	°C																	
Top Egg Shelf	°C																	
Bottom Egg Shelf	°C																	
Dairy	°C																	
Crisper	°C																	
Inlet-Evap.	°C	-18.5																
Outlet-Evap.	°C	-19.5																
Inlet-Cond.	°C	85.5																
Outlet-Cond.	°C	59																
Middle Point Cond.	°C	-																
Room	°C	43																

Tested By:

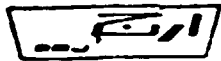

Research & Development Laboratories Performance Sheet

refrigerator (12 cub. ft)

Continuous Run

No. 2

Room 2		Station 3		Date		March 95			
Test No. 1484		Model 6247a		Ambient °C		43			
Compressor ESC7H		Thermostat Ranco		Control Pos.		Max (short)			
Overload		Charge R134a 158gr		kwhr Per Day		3	3	8	4
Remarks: Compressor Necchi - 1/6 hp						Avg. Cab. Air °C		-14.4 / 3.2	
						Percent Run		1 0 0 0	
						Average Watts		1 4 1 1	
						Cycles Per Day			
						Suction C.I.			
						Pressure C.O.			
						Discharge Pres-			
						Barometer		658 mm Hg	
12	2	1413	200	2651	282				
10		1213		2369					
ACTUAL Clock Time	Elapsed Time	Running Time Clock	Running Time	kwhr Meter	kwhr/ Elapsed Time				

Time													AVG.
EVAPORATOR	°C	-14.6											
CABINET	T.	°C	2										
	T.	°C	4										
	T.	°C	3.6										
Compressor Shell	°C	96.5											
Suction Line	°C	31.5											
Thermostat	°C	-18.8											
Evap. highest Point	°C												
Top Egg Shell	°C												
Bottom Egg Shell	°C												
Dair	°C												
Crisper	°C												
Inlet-Evap.	°C	-19.5											
Outlet-Evap.	°C	-18.6											
Inlet-Cond.	°C	87											
Outlet-Cond.	°C	60											
Middle Point-Cond.	°C	-											
Room	°C	43											

Tested By :

Spec of Research & Development

Research & Development Laboratories Performance Sheet

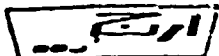

Refrigerator (12 cub. ft)

Continuous Run

No. 3

Room 1	Station 2	Date	March 95	
Test No. 1894	Model 6247 a	Ambient °C	43	
Compressor ESC7H	Thermostat Ranco	Control Pos.	Max (short)	
Overload	Charge R134a 160 gr	kwhr Per Day	3	4
Remarks: Compressor Necchi - 1/6 hp		Avg. Cab. Air °C	-14.1	3.20
		Percent Run	1	0
		Average Watts	1	4
		Cycles Per Day		
		Section C.I.		
		Pressure C.O.		
		Discharge Press.		
		Barometer	658 mm Hg	

10	2	16201	200	2365				
3		14201		2081	284			
Actual Clock Time	Elapsed Time	Running Time Clock	Running Time	Kwhr Meter	Kwhr/Elapsed Time			

Time										AVG.
EVAPORATOR	°C	-14.3								
CABINET	T.	°C	2							
	T.	°C	4.1							
	T.	°C	3.7							
Compressor Shell	°C	97								
Suction Line	°C	32								
Thermostat	°C	-18.8								
Evap. highest Point	°C									
Top Egg Shelf	°C									
Bottom Egg Shelf	°C									
Dairy	°C									
Crisper	°C									
Inlet-Evap.	°C	-49.4								
Outlet-Evap.	°C	-18.5								
Inlet-Cond.	°C	88								
Outlet-Cond.	°C	61								
Middle Point-Cond.	°C									
Room	°C	43								

Tested By .

Spec of Research & Development

Research & Development Laboratories Performance Sheet

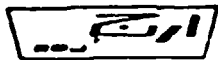

- Refrigerator (12 cub. ft.)

Continuous Run

No. 4

Room	2	Station	2	Date	March 95			
Test No.	1898	Model	6247a	Ambient °C	43			
Compressor	ESC7H	Thermostat	Ranco	Control Pos.	Max: short			
Overload		Charge	R134a 162gr.	kwhr Per Day	3	4	2	0
Remarks: COMPRESSOR VECKI 1/6 hp				Avg. Cab. Air °C	-14.3 / 3.23			
<div style="display: flex; justify-content: space-between;"> <div style="width: 15%; text-align: center;">12</div> <div style="width: 15%; text-align: center;">10</div> <div style="width: 15%; text-align: center;">Elapsed Time</div> <div style="width: 15%; text-align: center;">Running Time</div> <div style="width: 15%; text-align: center;">Running Time</div> <div style="width: 15%; text-align: center;">Kwhr Meter</div> <div style="width: 15%; text-align: center;">Ewhr/Elapsed Time</div> </div>				Percent Run	1	0	0	%
				Average Watts	1	4	3	
				Cycles Per Day				
				Section C.I.				
				Pressure C.O.				
				Discharge Press.				
Serometer					658 mm Hg			

Time	Temp	°C	°F	°C	°F	AVG.
EVAPORATOR	°C	-14.3				
CABINET	T.	°C	2			
	T.	°C	4.1			
	T.	°C	3.7			
Compressor Shell	°C	97				
Suction Line	°C	32				
Thermostat	°C	-18.6				
Evap. highest Point	°C					
Top Egg Shell	°C					
Bottom Egg Shell	°C					
Dairy	°C					
Crisper	°C					
Inlet-Evap.	°C	-19.4				
Outlet-Evap.	°C	-18.4				
Inlet-Cond.	°C	89				
Outlet-Cond.	°C	62				
Middle Point-Cond.	°C					
Room	°C	43				

Tested By :

Spec of Research & Development

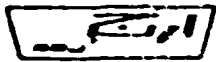

Research & Development Laboratories Performance Sheet

REFRIGERATOR (12 Cub.ft.)

Continuous Run

No. 5

Room 2	Station 1	Date Sept. 95			
Test No. 2073	Model 6247a	Ambient °C		32	
Compressor ESC7H	Thermostat Ranco	Control Pos.		Max (short)	
Overload	Charge R134a 155gr	kwhr Per Day		3	0
Remarks: Compressor Necchi 1/6 hp.		Avg. Cab. Air °C		-14.2	-3.4
		Percent Run		1	0
		Average Watts		1	2
		Cycles Per Day			
9	2	6516	200	1679	258
7		6416	Running	1421	Kwhr/Elapsed Time
Actual Clock Time	Elapsed Time	Running Time Clock	Running Time	Kwhr Meter	
		Section C.I.			
		Pressure C.O.			
		Discharge Press.			
		Barometer		658 mmHg	

Time												AVG.
EVAPORATOR	°C	14.2										
CABINET	T.	°C	-4									
	T.	°C	-3.1									
	T.	°C	-3.2									
Compressor Shell	°C	84										
Suction Line	°C	31										
Thermostat	°C											
Evap. highest Point	°C											
Top Egg Shell	°C											
Bottom Egg Shell	°C											
Dairy	°C											
Cheese	°C											
Inlet-Evap.	°C	-18.7										
Outlet-Evap.	°C	-17.4										
Inlet Cond.	°C	64										
Outlet Cond.	°C	47										
Middle Point-Cond.	°C											
Room	°C	32										

Tested By :

Proc of Research & Development

Research & Development Laboratories

No. 1

TEST: Pull down	TEST No. 1031	DATE: March 95
VOLTS: 220 CYC. 50Hz	MODEL No. 6247a	ROOM: 3 STA. 2
CHARGE: R134a-155 gr	COMP No.	ASSIENT: 43°C

OVERFLOW: -									
ISOLATOR ÷ LEADS:									
		Ro:				To:		ISO. No.	
Time	0	10 Min.	25	50	120	180	240		
AMPS.	-	1.27	1.17	1.1	1.05	1.02	1.02		
WATTS	-	215	182.5	165	150	145	142.5		
Suct. Pressure	-	-	-	-	-	-	-		
Evaporator °C	43	32	14.5	-1.5	-8.5	-11	-12.5		
Cabinet	T ₁ °C	43	41.5	36	24	13.5	8.5	5.7	
	T ₂ °C	43	42	38	27.5	16.5	11	8.3	
	T ₃ °C	43	42	38	27.5	16	10.5	7.5	
Compressor Shell °C	43	62	78	92	98	98	97		
Suction Line °C	43	21.5	19.5	16.5	15	15	15		
Thermostat °C	43	-2.5	-9.5	-13.5	-15.5	-17	-17.5		
Inlet. Evap. °C	43	-2	-8.5	-13	-15	-16.5	-17		
Outlet. Evap. °C	43	2	-6	-12	-16.5	-18.5	-20		
Inlet Cond. °C	43	80	85.5	90	92	89	88		
Outlet Cond. °C	43	69	66.5	63	62	61.5	61		
Room °C	43	43	43	43	43	43	43		

COMPLETION TIME: 240 Min. No. OF CUT-OUTS: _____ TOTAL OFF TIME: _____

me									
AMPS.									
WATTS									
Suct. Pressure									
T. C. °C									
P.C.	T ₁ °C								
	T ₂ °C								
	T ₃ °C								
Compressor Shell °C									
Suction Line °C									
Ice Tray °C									
Wicking °C									
Bridge Ω									
Room °C									

Tested by _____

Head of Research & Development

TEST: PULL DOWN	TEST No. 1231	DATE: MARCH 95
VOLTS: 220 CYC. 50 Hz	MODEL No. 624 a	ROOM: 2 STA. 1
CHARGE R 134a - 158 gr.	COMP No.	AMBIENT: 43°C

OVERLOAD :

ISOLATOR + LEADS :

Ro :

To :

ISO . No.

Time	0 Min	10	25	60	120	180	242						
AMPS.		1.28	1.18	7.15	1.06	1.04	1.03						
WATTS		217	183	169	15.	146	143						
Suct. Pressure													
EVAPORATOR °C	43	33	14.4	-1.6	-8.4	-10.8	-12.3						
CABINET	T. °C	43	42	37	25	14.5	9.5	5.8					
	T. °C	43	43	39	28.5	17	12	8.4					
	T. °C	43	43	39	28.5	17	12	7.6					
Compressor Shell °C	43	64	79	93	98	99	98						
Suction Line °C	43	22	20	17	15.6	15.5	16						
THERMOSTAT °C	43	-2.6	-9.7	-13.7	-15.6	-17.1	-17.4						
OUTLET EVAP. °C	43	-1.9	-7.5	-12.5	-15.8	-18.4	-16.7						
INLET EVAP. °C	43	-1.9	-5.5	-11.5	-16	-18.4	-19.5						
OUTLET COND. °C	43	81	86	90	93	90	89						
INLET COND. °C	43	70	67	67	63	62	62						
Room °C													

COMPLETION TIME 242 Min.

No. OF CUT-OUTS _____ TOTAL OFF TIME _____

AMPS.													
WATTS													
Suct. Pressure													
F. C. °C													
P.C.	T. °C												
	T. °C												
	T. °C												
Compressor Shell °C													
Suction Line °C													
Ice Tray °C													
Welding °C													
Bridge	2												
Room °C													

Tested by

TEST: PULL DOWN	TEST No. 1246	DATE: MARCH 95
VOLTS: 220 CYC. 50 HZ	MODEL No. 6247 a	ROOM: STA. 2
CHARGE: R 134a - 160 gr.	COMP No.	AMBIENT: 43°C

OVERFLOW :

ISOLATOR ÷ LEADS :

Ro :

To :

ISO . No.

Time	D Min	10	25	60	120	180	244						
AMPS.		1.28	1.19	1.16	1.07	1.09	1.04						
WATTS		218	183	168	151	147	144						
Suct. Pressure													
EVAPORATOR °C	43	34	14.3	-1.6	-8.3	-10.7	-12.2						
CABINET	T ₁ °C	43	42	37	26	15	9.6	5.9					
	T ₂ °C	43	44	40	29	17.2	12.1	8.35					
	T ₃ °C	43	42	39	29	18	13	7.59					
Compressor Shell °C	43	65	79	94	99	100	99						
Suction Line °C	43	23	19.5	17	15.4	15.6	17						
THERMOSTAT °C	43	-2.5	-9.6	-13.6	-15.6	-17.2	-17.5						
INLET EVAP. °C	43	-1.9	-7.4	-12.3	-15.4	-16.3	-16.8						
OUTLET EVAP. Ω	43	1.5	-5.5	-11.4	-16	-18.3	-19.4						
INLET COND. °C	43	81	86	90	93	91	90						
OUTLET COND °C	43	70	67	64	64	63	64						
Room °C	43	43	43	43	43	43	43						

COMPLETION TIME 244 min

No. OF CUT-OUTS TOTAL OFF TIME

me													
AMPS.													
WATTS													
Suct. Pressure													
F. C. °C													
P.C.	T ₁ °C												
	T ₂ °C												
	T ₃ °C												
Compressor Shell °C													
Suction Line °C													
Ice Tray °C													
Winding °C													
Bridge 2													
Room °C													

TEST: PULL DOWN		TEST No. 1277						DATE: March 95	
VOLTS: 220		CYC. 50 Hz		MODEL No. 6247 a				ROOM: 2 STA. 2	
CHARGE: R 134a- 162 gr		COMP No.						AMBIENT: 43°C	
OVERLOAD:									
ISOLATOR ÷ LEADS:									
		Ro:			To:			ISO. No.	
Time		10	25	60	120	189	247		
AMPS.		1.28	1.19	1.16	1.07	1.01	1.05		
WATTS		218	183	168	151	148	145		
Suct. Pressure									
EVAPORATOR °C		43	34	14.3	-1.6	-8.3	-10.7	-12.2	
CABINET	T ₁ °C	43	42	37	26	15	9.6	5.7	
	T ₂ °C	43	44	40	29	17.2	12.1	8.3	
	T ₃ °C	43	42	39	29	18	14	7.5	
Compressor Shell °C		43	65	79	94	99	100	99	
Suction Line °C		43	93	20	17	16	16	17.5	
THERMOSTAT °C		43	-2.6	-9.6	-13.5	-15.5	-17.1	-17.4	
INLET EVAP. °C		43	-1.9	-7.4	-12.5	-15.4	-16.2	-16.7	
OUTLET EVAP °C		43	1.55	-5.5	-11.4	-16	-18.2	-16.7	
INLET COND °C		42	83	86	90	93	91	90	
OUTLET COND °C		43	70	67	65	65	63	65	
Room °C		43	43	43	43	43	43	43	

COMPLETION TIME 247 Min No. OF CUT-OUTS _____ TOTAL OFF TIME _____

me									
AMPS.									
WATTS									
Suct. Pressure									
F. C. °C									
P.C.	T ₁ °C								
	T ₂ °C								
	T ₃ °C								
Compressor Shell °C									
Suction Line °C									
Ice Tray °C									
Winding °C									
Bridge Ω									
Room °C									

Tested by

Head of Research & Development

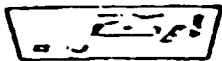

Research & Development Laboratories Performance Sheet

Refrigerator (12 cu.ft)

cycling Run.

No.1

Room 1		Station 2			Date		March 95			
Test No. 1033		Model 6247a			Ambient °C		43			
Compressor ESC 7H		Thermostat			Control Pos.		MID.			
Overload -		Charge R134a 155 gr			Kwhr Per Day		2	7	1	2
Remarks: Compressor Necchi 1/6 hp					Avg. Cab/Air °C		-9.5 / 6.5			
					Percent Run		7	5	%	
					Average Watts		1	1	3	
					Cycles Per Day		72			
					Suction C.I.					
					Pressure C.O.					
					Discharge Press.					
					Barometer		658 mm Hg			
10	2	265	150	286	226					
8		115		60						
Actual Clock Time	Elapsed Time	Stopping Time Clock	Running Time	Kwhr Meter	Kwhr/Elapsed Time					

Time		Cut out	Cut in												AVG.
Evaporator	°C	-10	-9												
Cabinet	T ₁	°C	5	5											
	T ₂	°C	7.5	7.5											
	T ₃	°C	7	7											
Compressor Suction	°C	89.5	89.5												
Suction Line	°C	17	35.5												
Thermostat	°C	-17.5	-6.5												
Evap. highest Point	°C														
Top Egg Shelf	°C														
Bottom Egg Shelf	°C														
Dairy	°C														
Crisper	°C														
Inlet-Evap.	°C	-17	-1.5												
Outlet-Evap.	°C	-12.5	-1.5												
Inlet-Cond.	°C	83.5	46												
Outlet-Cond.	°C	60	67												
Middle Point-Cond.	°C														
Room	°C	43	43												

Tested By:

Head of Research & Development

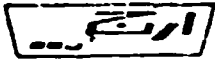

Research & Development Laboratories Performance Sheet

Refrigerator(12 cubft)

Cycling Run

No.2

Room 1	Station 4	Date	March 95																																						
Test No. 1921	Model 6247a	Ambient °C	43																																						
Compressor ESC7H	Thermostat Danfoss	Control Pos.	MID																																						
Overload	Charge R134a 158 gr	kwhr Per Day	2	7 3 6																																					
Remarks: Compressor Neuchi 1/6 hp		Avg. Cab. Air °C	-9.45 / 6.56																																						
<table border="1" style="width: 100%; border-collapse: collapse;"> <tr> <td style="width: 15%;"></td> <td style="width: 15%;"></td> <td style="width: 15%;"></td> <td style="width: 15%;"></td> <td style="width: 15%;"></td> <td style="width: 15%;"></td> </tr> <tr> <td style="width: 15%;"></td> <td style="width: 15%;"></td> <td style="width: 15%;"></td> <td style="width: 15%;"></td> <td style="width: 15%;"></td> <td style="width: 15%;"></td> </tr> <tr> <td style="width: 15%;"></td> <td style="width: 15%;"></td> <td style="width: 15%;"></td> <td style="width: 15%;"></td> <td style="width: 15%;"></td> <td style="width: 15%;"></td> </tr> <tr> <td style="width: 15%;"></td> <td style="width: 15%;"></td> <td style="width: 15%;"></td> <td style="width: 15%;"></td> <td style="width: 15%;"></td> <td style="width: 15%;"></td> </tr> <tr> <td style="width: 15%;"></td> <td style="width: 15%;"></td> <td style="width: 15%;"></td> <td style="width: 15%;"></td> <td style="width: 15%;"></td> <td style="width: 15%;"></td> </tr> <tr> <td style="width: 15%;"></td> <td style="width: 15%;"></td> <td style="width: 15%;"></td> <td style="width: 15%;"></td> <td style="width: 15%;"></td> <td style="width: 15%;"></td> </tr> </table>																																						Percent Run	6	5	%
		Average Watts	1	1	4																																				
		Cycles Per Day	73																																						
		Suction C.I.																																							
		Pressure C.O.																																							
		Discharge Press.																																							
11	2	1270	150	459	228																																				
9		1120		231																																					
Actual Clock Time	Elapsed Time	Running Time Clock	Running Time	Kwhr Meter	Kwhr/Elapsed Time																																				
				Barometer																																					
				558 mm Hg																																					

Time		Out	In																AVG.
EVAPORATOR	°C	-10	-8.9																
CABINET	T ₁	°C	5	5															
	T ₂	°C	7.6	7.6															
	T ₃	°C	7.1	7.1															
Compressor Shell	°C	89	89																
Suction Line	°C	18	36																
Thermostat	°C	-17.5	-6.4																
Evap. highest Point	°C																		
Top Egg Shell	°C																		
Bottom Egg Shell	°C																		
Dairy	°C																		
Crisper	°C																		
Inlet-Evap.	°C	-17	-1.5																
Outlet-Evap.	°C	-16.6	-1.6																
Inlet-Cond.	°C	84	47																
Outlet-Cond.	°C	60	67																
Middle Point-Cond.	°C																		
Room	°C	43	43																

Tested By :

Head of Research & Development

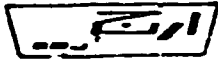

Research & Development Laboratories Performance Sheet

Refrigerator (12 cub. ft.)

Cycling Run

No. 3

Room 2	Station 4	Date	March 95	
Test No. 1561	Model 6247a	Ambient °C	43	
Compressor ESC7H	Thermostat Danfoss	Control Pos.	MID	
Overload	Charge R132a - 160gr	kwhr Per Day	2	7
Remarks: Compressor Necchi - 1/6 hp		Avg. Cab. Air °C	-9.4/6.61	
		Percent Run	6	6
		Average Watts	1	1
		Cycles Per Day	74	
		Section C.I.		
		Pressure C.O.		
		Discharge Press.		
		Barometer	658 mm Hg	

11	2	1741	152	680	229
9		1589	152	451	
Actual Clock Time	Elapsed Time	Running Time Clock	Running Time	Kwhr Meter	Kwhr/Elapsed Time

Time		Cutout	Cut in								AVG.
EVAPORATOR	°C	-9.9	-8.9								
CABINET	T.	°C	5.1	5.1							
	T.	°C	7.6	7.7							
	T.	°C	7.15	7.15							
Compressor Shell	°C	90	91								
Suction Line	°C	19	39								
Thermostat	°C	-17.4	-6.5								
Evap. highest Point	°C										
Top Egg Shell	°C										
Bottom Egg Shell	°C										
Dairy	°C										
Crisper	°C										
Inlet-Evap.	°C	-17.1	-1.6								
Outlet-Evap.	°C	-16.7	-1.8								
Inlet-Cond.	°C	85	48								
Outlet-Cond.	°C	61	69								
Middle Point-Cond.	°C										
Room	°C	43	43								

Tested By :

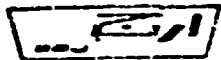

Research & Development Laboratories Performance Sheet

Refrigerator (12 cub ft)

Cycling Run

No. 4

Room 1	Station 1	Date	March 95	
Test No. 1884	Model 6247a	Ambient °C	43	
Compressor ESC7H	Thermostat Ranco	Control Pos.	MID	
Overload	Charge R134a 162 g	kwhr Per Day	2	7
Remarks: Compressor Necchi - 1/6 hp		Avg. Cab. Air °C	-9.3	6.7
		Percent Run	6	6
		Average Watts	1	1
		Cycles Per Day		
		Section C.I.		
		Pressure C.O.		
		Discharge Press.		
		Barometer	658 mm Hg	

12	2	944	152	1019	230
D		792		789	
Actual Clock Time	Elapsed Time	Running Time Clock	Running Time	Kwhr Meter	Kwhr/Elapsed Time

Time		Cutout	Cut in							AVG.
EVAPORATOR	°C	-9.8	-8.8							
CABINET	T.	°C	5.2	5.2						
	T.	°C	7.7	7.7						
	T.	°C	7.2	7.2						
Compressor Shell	°C	81	92							
Suction Line	°C	20	40							
Thermostat	°C	-17.5	-6.7							
Evap. highest Point	°C									
Top Egg Shelf	°C									
Bottom Egg Shelf	°C									
Door	°C									
Crisper	°C									
Inlet-Evap.	°C	-17.2	-1.7							
Outlet-Evap.	°C	-16.7	-1.9							
Inlet-Cond.	°C	86	50							
Outlet-Cond.	°C	62	70							
Middle Point-Cond.	°C									
Room	°C	43	43							

Tested By :

Head of Research & Development

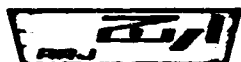

Prototype No.1

Ice Freeze Performance Sheet	
Model	6247a
Compressor Power	1/6 hp - ESC7H
Ambient	32 °c
Thermostat position	Shorted
Volts /Amper	220 V/1.1A
Percentage working	Continous
Freezer air	-12.2 °c
Cabinet mean Temp.	5.7 °c
Compressor Sheet Temp.	85 °c
Inlet Cond.Temp.	76 °c
Outlet Cond.Temp.	49 °c

Remarks : Within 4 hours and 8 minutes ice Temp. reached to -7 °c

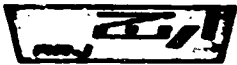

Prototype No.2

Ice Freeze Performance Sheet	
Model	6247a
Compressor Power	1/6 hp - ESC7H
Ambient	32 °c
Thermostat position	Shorted
Volts /Amper	220 V/1.1A
Percentage working	Continous
Freezer air	-12.2 °c
Cabinet mean Temp.	5.7 °c
Compressor Sheet Temp.	85 °c
Inlet Cond.Temp.	76 °c
Outlet Cond.Temp.	49 °c

Remarks : Within 4 hours & 10 minutes Ice Temp. reached to -7 °c

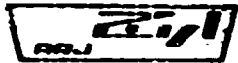

Prototype No.3

Ice Freeze Performance Sheet	
Model	6247a
Compressor Power	1/6 hp - ESC7H
Ambient	32 °c
Thermostat position	Shorted
Volts /Amper	220 V/1.1A
Percentage working	Continous
Freezer air	-12.1 °c
Cabinet mean Temp.	5.6 °c
Compressor Sheet Temp.	86 °c
Inlet Cond.Temp.	77 °c
Outlet Cond.Temp.	50 °c

Remarks : Within 4 hours and 12 minutes Ice Temp. reached to -7 °c

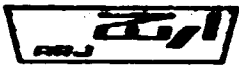

Prototype No. 4

Ice Freeze Performance Sheet	
Model	6247a
Compressor Power	1/6 hp - ESC7H
Ambient	32 °c
Thermostat position	Shorted
Volts /Amper	220 V/1.1A
Percentage working	Continuous
Freezer air	-12.1 °c
Cabinet mean Temp.	5.6 °c
Compressor Sheet Temp.	87 °c
Inlet Cond.Temp.	78 °c
Outlet Cond.Temp.	51 °c

Remarks : Within 4 hours and 15 minutes Ice Temp. reached to -7 °c



ARJ CORPORATION شرکت ارج ساز

MODEL 6243a



CALCULATION AND EQUIPMENT SELECTION FOR MODEL 6243a

TRANSMISSION LOAD

$$Q1 = U * A * DT$$

$$c = U * A$$

$$\text{Constant } c = \frac{p}{t1-t}$$

$$c = \frac{21.1}{42-27}$$

$$c = 1.41 \text{ w/k}$$

$$c1 = K * A1$$

$$c2 = K * A2$$

A1 = effective heat transfer area of freezer compartment

A2 = effective heat transfer area of cooling compartment

Therefore

$$Qt = Qt1 + Qt2$$

$$Qt1 = c1 * Dt1$$

$$Qt2 = c2 * Dt2$$

Where

Qt1 = transmission heat relative to freezer compartment.

Qt2 = transmission heat relative to cooling compartment.

$$Dt1 = ta - ti1$$

$$Dt2 = ta - ti2$$



$t_{i1} = -12^{\circ}\text{C}$ for two star refrigerator

$t_{i2} = 5^{\circ}\text{C}$ Avarage Temp. of inside cabinet

$t_a = 43^{\circ}\text{C}$ Ambinet Temp.

A_{fo} = out side area of the freezer compartment

$A_{fo} = 2A_{3e} + A_{1+2A_{2e}}$

$A_{fo} = 12017 \text{ cm}^2$

A_{fi} = Inside area of the refrigerator compartment.

$A_{fi} = 2A_{3e} + A_{1+2A_{3e}}$

$A_{ro} = 22746 \text{ cm}^2$

A_{ri} = inside area of the refrigerator compartment

$A_{ri} = 16656 \text{ cm}^2$

$A_m = \sqrt{A_i * A_o}$ mean value

$A_{mf} = 0.7775$ for freezer compartment

$A_{mr} = 1.946 \text{ m}$ for refrigerator compartment

$A = A_{mf} + A_{mr}$

$A = 2.793 \text{ m}^2$

$U = 1.41 / 2.723 = 0.517 \text{ w/m}^2 \text{ k}$

$Q_{tr} = U * A * DT$

$Q_{tr} = 0.517 * 1.946 * 38$ for refrigerator compartment

$Q_{tr} = 38.2 \text{ watt}$

$Q_{tf} = 0.517 * 0.7775$

$Q_{tf} = 22.10$ for freezer compartment

$Q_t = Q_{tr} + Q_{tf}$

$Q_t = 60.3 \text{ watt}$

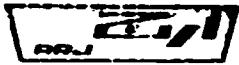

PRODUCTION LOAD

$$Q_{pd} = \sum Q_{pr} + \sum Q_{pf} + \sum Q_{ef} + \sum Q_{lk}$$

Where

Q_{pr} = Heat removed from products above freezeing point

No.	Product	Weight	Specific heat	Initial Temp.	Final Temp.
1	Meat	3 Kg	3.14 kJ/kg °k	28 °c	5 °c
2	Butter	1.5 "	2.68 "	10 "	5 "
3	Vegetable	3 "	3.77 "	20 "	10 "
4	Fruit	3 "	3.81 "	20 "	10 "
5	Water	1.5 "	4.18 "	20 "	10 "
6	Milk	1.5 "	3.76 "	10 "	5 "

Therefore

$$Q_{pr1} = 3 \times 3.14 (28-5) = 216.66 \text{ kJ}$$

$$Q_{pr2} = 1.5 \times 2.68 (10-5) = 20.10 \text{ "}$$

$$Q_{pr3} = 3 \times 3.77 (20-10) = 113.10 \text{ "}$$

$$Q_{pr4} = 3 \times 3.81 (20-10) = 114.30 \text{ "}$$

$$Q_{pr5} = 1.5 \times 4.18 (20-10) = 62.70 \text{ "}$$

$$Q_{pr6} = 1.5 \times 3.76 (10-5) = 28.20 \text{ "}$$

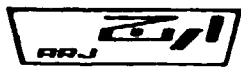

$$Q_{pr} = 555.06 \text{ kj}$$

For the Freezer Part of Refrigerator

Q_{pf} = Heat removed of products from intial Temp. to freezing point

$$Q_{pf} = W * C_p * DT$$

$$Q_{pf1} = 38.95 \text{ kj For Fish}$$

$$Q_{pf2} = 178.98 \text{ kj For Meat}$$

$$Q_{pf} = 217.93 \text{ kj}$$

Q_{lf} = Heat removed from freezing point to $-12^{\circ}c$ Evap.Temp.

$$Q_{lf} = W * C_p * DT$$

Where

Product	Weight	Initial Temp.	Freezing point	Cp before freezing	Cp after freezing
Fish	1 Kg	$10^{\circ}c$	$-2.25^{\circ}c$	3.18 kj/kg $^{\circ}K$	1.72 kj/kg $^{\circ}K$
Meat	2 "	$28^{\circ}c$	$-0.5^{\circ}c$	3.14 "	1.67 "

$$Q_{lf1} = 1 \times 1.72 [-2.25 - (-12)] = 16.77 \text{ Kj}$$

$$Q_{lf2} = 2 \times 1.67 [-0.5 - (-12)] = 38.41 \text{ kj}$$

$$Q_{lf} = Q_{lf1} + Q_{lf2}$$

$$Q_{lf} = 55.18 \text{ kj}$$

Q_{lf} = Heat removed to freezer product

$$Q_{lf} = W * h_i$$



Where

W = Average weight of product per kg

W1 = 1 kg Fish

W2 = 2 kg Meat

hi = Latent heat per Kj/kg

hi1 = 228 kj/kg for Meat

hi2 = 235 kj/kg for Fish

Q1f = Q1f1 + Q1f2

Q1f = 235 + 456

Q1f = 691 kj

Q1k = Heat removed of 1/2 kg water for ice making from 10 °c to -12 °c

Q1k = 201.44 kj as it is colculated for model 6246a

So = Total production load will be

$\sum Q_{pd} = 555.06 + 217.93 + 55.18 + 691 + 201.44$

$\sum Q_{pd} = 1720.6 \text{ Kg}$

Qpd = 29.8 watt

Sum of transmission and production load

Qc = Qt + Qpd

Qc = 60.30 + 29.8

Qc = 90.1 watt

For air changing load 10 % is taken

Qa = 9 watt

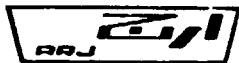

Therefore cooling capacity will be

$$Q_{cc} = 99 \text{ watt}$$

CONDENSER,S POWER DETERMINATION

We know that $\frac{S(\text{Kcal/h}) \times 1.25}{DT}$

Operational condition a) $K_s = 99 \times 0.8605 \times 1.25 / 55 - 43 = 8.87 \text{ Kcal/h}^{\circ}\text{K}$

b) $K_s = 99 \times 0.8605 \times 1.25 / 55 - 32 = 4.62 \text{ Kcal/h}^{\circ}\text{K}$

According to static wired condenser series 40 - 51 - 476 (see page 208)

The suitable condensor dimension is taken :

No of leg : 14

The wide of the condenser : 468 mm

The length of the condenser : 674 mm

CAPILLARY,S CAPACITY DETERMINATION

We know that

$$V_a = 2.35 \sqrt{\rho^{-1} * a^{2.5} * L^{-0.5}}$$

According to the vapour table (see page 203)

at -23.3°C the specific valume of vapoure = $0.171 \text{ m}^3/\text{kg}$

Asuming mass flow rate 2.90 kg/h of R134a



Therefore

$$V_a = 2.90 \times 0.171 \times 1000/50 = 8.26 \text{ l/min}$$

at 55 °c condensation Temp. the pressure is (see page 205)

$$P = 14.9 \text{ kg/cm}^2$$

By applying the above formulae

$$8.12 = 2.35 \sqrt{14.90 - 1} * 0.79 * a^{2.5} * L^{-0.5}$$

$$L = 5.50 \text{ meter}$$

EVAPORATOR,S DETERMINATION

We know that

$$Q_{cc} = Q_{ev} = U * A * DT$$

U = Coefficient of heat transmission of evaporator

$$U = 4.7 \text{ w/m}^2 \text{ k} \text{ (as it is calculated for model 6246a)}$$

Therefore

$$99 = A \times 4.9 \times 11.3$$

$$A = 1.86 \text{ m}^2$$

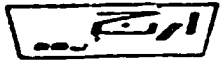

Research & Development Laboratories Performance Sheet

REFRIGERATOR (7 cub. ft.)

Continuous Run

No. 2

Room 1		Station 4		Date March 95	
Test No. 1717		Model 6243 a		Ambient °C 43	
Compressor NR45LAEG		Thermostat Ranco		Control Pos. Max (short)	
Overload		Charge 134a 132gr		kwhr Per Day 2 5 4 4	
Remarks: Compressor Geld star - 1/8 hp					
				Avg. Cab. Air °C -12/1	
				Percent Run 1 0 0 %	
				Average Watts 1 0 6	
				Cycles Per Day	
				Suction C.I.	
				Pressure C.O.	
				Discharge Press-	
				Barometer 658 mmHg	

10	2	757	200	1532	212
8		557		1425	
Actual Clock Time	Elapsed Time	Running Time Clock	Running Time	kwhr Meter	kwhr/Elapsed Time

Time											AVG.
EVAPORATOR	°C	-12									
CABINET	T.	°C	1								
	T.	°C	1.1								
	T.	°C	0.9								
Compressor Shell	°C	93									
Suction Line	°C	39									
Thermostat	°C	-18									
Evap. highest Point	°C										
Top Egg Shell	°C										
Bottom Egg Shell	°C										
Dairy	°C										
Crisper	°C										
Inlet-Evap.	°C	-19.4									
Outlet-Evap.	°C	-18.4									
Inlet-Cond.	°C	89									
Outlet-Cond.	°C	60									
Middle Point-Cond.	°C										
Room	°C	43									

Tested By :

Head of Research & Development



Research & Development Laboratories Performance Sheet

Refrigerator (7cu.ft)

Continuous Run at 220 V

No.1

Room 2	Station 3	Date	March 95	
Test No. 1037	Model 6243a	Ambient °C	43	
Compressor NR45 LAEG	Thermostat Ranco	Control Pos.	MAX.	
Overload	Charge R134a 130 gr	kwhr Per Day	2	5
Remarks: Compressor Necchi 1/8 Hp		Avg. Cdb/Air °C	2	0
		Percent Run	1	0
		Average Watts	1	0
		Cycles Per Day		
		Suction C.I.		
		Pressure C.O.		
		Discharge Press.		
		Barometer	658 mm Hg	

Time										AVG.
Evaporator	°C	-12.1								
Cabinet	T ₁	°C	1							
	T ₂	°C	1.1							
	T ₃	°C	0.9							
Compressor Suel	°C	93								
Suction Line	°C	38								
Thermostat	°C	-18								
Evap. highest Point	°C									
Top Egg Shell	°C									
Bottom Egg Shell	°C									
Dairy	°C									
Crisper	°C									
Inlet-Evap.	°C	-19.5								
Outlet-Evap.	°C	-18.5								
Inlet-Cond.	°C	87								
Outlet-Cond.	°C	60								
Middle Post-Cond.	°C	-								
Room	°C	43								

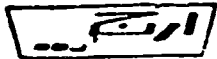

Research & Development Laboratories Performance Sheet

REFRIGERATOR (7 Cub.Ft)

Continuous Run

No.3

Room	2	Station	3	Date	March 95			
Test No.	1727	Model	6243	Ambient °C	43			
Compressor	NR45LAEG	Thermostat	Ranco	Control Pos.	Max (short)			
Overload		Charge	R134a 134gr	kwhr Per Day	2	5	6	8
Remarks: Compressor Gold Star -1/8 hp				Avg. Cab. Air °C	-11.9/ 0.96			
				Percent Run	1	0	0	%
				Average Watts	1	0	7	
				Cycles Per Day				
				Suction C.I.				
				Pressure C.O.				
				Discharge Press-				
				Barometer	658 mm Hg			

Actual Clock Time	Elapsed Time	Burning Time Clock	Running Time	Kwhr Meter	Kwhr/Elapsed Time
12	2	827	200	1822	214
10		627		1608	

Time																			AVG.
EVAPORATOR	°C	-11.92																	
CABINET	T ₁	°C	0.9																
	T ₂	°C	1																
	T ₃	°C	1																
Compressor Shell	°C	94																	
Suction Line	°C	40																	
Thermostat	°C	-17.5																	
Evap. highest Point	°C																		
Top Egg Shell	°C																		
Bottom Egg Shell	°C																		
Dairy	°C																		
Crisper	°C																		
Inlet-Evap.	°C	-19.3																	
Outlet-Evap.	°C	-18.4																	
Inlet-Cond.	°C	90																	
Outlet-Cond.	°C	62																	
Middle Point-Cond.	°C																		
Room	°C	43																	

Tested By :

Head of Research & Development

Research & Development Laboratories Performance Sheet

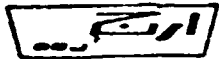

REFRIGERATOR (7 cub. ft)

Continuous Run

No. 4

Room	2	Station	2	Date	March 95																																							
Test No.	1747	Model	6243a	Ambient °C	43																																							
Compressor	NR45 LAEG	Thermostat	Ranco	Control Pos.	Max (short)																																							
Overload		Charge	R134a 135 gr	kwhr Per Day	2	5	8	0																																				
Remarks: Compressor Gold star - 1/8 hp				Avg. Cab. Air °C	-11.9 / 0.90																																							
<table border="1" style="width: 100%; border-collapse: collapse;"> <thead> <tr> <th>ACTUAL Clock Time</th> <th>Elapsed Time</th> <th>Running Time Clock</th> <th>Ramping Time</th> <th>Kwhr Meter</th> <th>Kwhr/Elapsed Time</th> </tr> </thead> <tbody> <tr> <td>12</td> <td>2</td> <td>917</td> <td>200</td> <td>1730</td> <td>215</td> </tr> <tr> <td>10</td> <td></td> <td>717</td> <td></td> <td>1515</td> <td></td> </tr> <tr> <td></td> <td></td> <td></td> <td></td> <td></td> <td></td> </tr> <tr> <td></td> <td></td> <td></td> <td></td> <td></td> <td></td> </tr> <tr> <td></td> <td></td> <td></td> <td></td> <td></td> <td></td> </tr> </tbody> </table>				ACTUAL Clock Time	Elapsed Time	Running Time Clock	Ramping Time	Kwhr Meter	Kwhr/Elapsed Time	12	2	917	200	1730	215	10		717		1515																				Percent Run	1	0	0	%
				ACTUAL Clock Time	Elapsed Time	Running Time Clock	Ramping Time	Kwhr Meter	Kwhr/Elapsed Time																																			
				12	2	917	200	1730	215																																			
				10		717		1515																																				
Average Watts	1	0	8																																									
Cycles Per Day																																												
Suction C.I.																																												
Pressure C.O.																																												
Discharge Press.																																												
Barometer	658 mm Hg																																											

Time											AVG.
EVAPORATOR	°C	-11.9									
CABINET	T ₁	°C	0.9								
	T ₂	°C	0.8								
	T ₃	°C	1.1								
Compressor Shell	°C	95									
Suction Line	°C	41									
Thermostat	°C	-17									
Evap. Highest Point	°C										
Top Egg Shell	°C										
Bottom Egg Shell	°C										
Dairy	°C										
Crisper	°C										
Inlet-Evap.	°C	-19									
Outlet-Evap.	°C	-18.2									
Inlet-Cond.	°C	90									
Outlet-Cond.	°C	64									
Middle Point-Cond.	°C										
Room	°C	43									

Tested By :

Head of Research & Development



Research & Development Laboratories Performance Sheet

REFRIGERATOR (7Cub.ft)

Continuous Run)

No.5

Room 7		Station		Date		Sept. 1995																																																																							
Test No. 1694		Model 6243a		Ambient °C		32																																																																							
Compressor NR45 LAEG		Thermostat Danfoss		Control Pos.		Max (short)																																																																							
Overload		Charge R134a 130gr		kwhr Per Day		2	2	5	6																																																																				
Remarks: Compressor Gold Star 1/8 hp						Avg. Cab. Air °C		-14.5/-3.8																																																																					
<table border="1" style="width: 100%; border-collapse: collapse; text-align: center;"> <tr><td> </td><td> </td><td> </td><td> </td><td> </td><td> </td></tr> <tr><td> </td><td> </td><td> </td><td> </td><td> </td><td> </td></tr> <tr><td> </td><td> </td><td> </td><td> </td><td> </td><td> </td></tr> <tr><td> </td><td> </td><td> </td><td> </td><td> </td><td> </td></tr> <tr><td> </td><td> </td><td> </td><td> </td><td> </td><td> </td></tr> <tr><td> </td><td> </td><td> </td><td> </td><td> </td><td> </td></tr> <tr><td> </td><td> </td><td> </td><td> </td><td> </td><td> </td></tr> <tr><td> </td><td> </td><td> </td><td> </td><td> </td><td> </td></tr> <tr><td> </td><td> </td><td> </td><td> </td><td> </td><td> </td></tr> <tr><td> </td><td> </td><td> </td><td> </td><td> </td><td> </td></tr> <tr><td> </td><td> </td><td> </td><td> </td><td> </td><td> </td></tr> </table>																																																																								Percent Run		1	0	0	0
Average Watts		9	4																																																																										
Cycles Per Day																																																																													
Section		C.J.																																																																											
Pressure		C.O.																																																																											
Discharge Press.																																																																													
Barometer		658				mm Hg																																																																							

Time											AVG.
EVAPORATOR	°C	-14.5									
CABINET	T.	°C	-4.2								
	T.	°C	-3.6								
	T.	°C	-3.8								
Compressor Shell	°C	60									
Suction Line	°C	30									
Thermostat	°C	-19.2									
Evap. highest Point	°C										
Top Egg Shell	°C										
Bottom Egg Shell	°C										
Dairy	°C										
Crisper	°C										
Inlet-Evap.	°C	-19.8									
Outlet-Evap.	°C	-19.1									
Inlet-Cond.	°C	63									
Outlet-Cond.	°C	45									
Middle Point-Cond.	°C										
Room	°C	32									

Tested By :

Dept of Research & Development

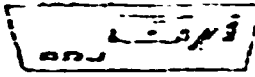

Research & Development Laboratories

Refrigerator (7 cu.ft)

No.1

TEST: Pull Down	TEST No: 1039	DATE: March 95
VOLTS: 220 CYC. 50Hz	MODEL No. 6243a	ROOM: 1 STA. 2
CHARGE:	COMP No.	AMBIENT: 43 C

OVERLOAD: -

ISOLATOR + LEADS :		Re :						To :		ISO . No.	
Time		0	10 MIN	25	60	120	240				
AMPS.		-	1.03	0.95	0.94	0.92	0.91				
WATTS		-	175	150	148	137	127				
Suct. Pressure		-	-	-	-	-	-				
Evaporator °C		43	31	16	1.6	-6	-9				
Cabinet	T ₁ °C	43	42	37	26	14.8	76				
	T ₂ °C	43	42	36	25	14	7				
	T ₃ °C	43	42	35.5	25	14	7				
Compressor Shell °C		43	59	80	39	94	95				
Suction Line °C		43	50	48	44	39	40				
Thermostat °C		43	5	-7	-11	-14	-16				
Inlet Evap. °C		43	-1	-8	-11	-15	-17				
Outlet Evap. Ω		43	10	-4	-12	-16	-18				
Inlet Cond. °C		43	86	86	93	92	89				
Outlet Cond. °C		43	76	67	66	63	63				
Room °C		43	43	43	43	43	43				

COMPLETION TIME - 240 Mins. No. OF CUT-OUTS - TOTAL OFF TIME -

me											
AMPS.											
WATTS											
Suct. Pressure											
F. C. °C											
P.C.	T ₁ °C										
	T ₂ °C										
	T ₃ °C										
Compressor Shell °C											
Suction Line °C											
Ice Tray °C											
Winding °C											
Bridge Ω											
Room °C											

Tested by

96

Head of Research & Development

TEST: PULL DOWN	TEST No. 1516	DATE: MARCH 95
VOLTS: 220 CYC. 50Hz	MODEL No. 6243 a	ROOM: 2 STA. 3
CHARGE: R134a - 132gr	COMP No.	AMBIENT: 43 C

OVERLOAD :									
ISOLATOR + LEADS :									
			Ro :				- To :		ISO . No.
Time	0 Min	10	25	60	120	142			
AMPS.		1.03	0.95	0.94	0.92	0.90			
WATTS		175	150	148	138	128			
Suct. Pressure									
EVAPORATOR °C	43	31	16	16	1-6	-9			
T. °C	43	42	37	26	14.8	76			
CABINET T. °C	43	42	36	25	14	7			
T. °C	43	42	36	26	15	8			
Compressor Shell °C	43	59	80	89	95	96			
Suction Line °C	43	59	49	44	39	40			
THERMOSTAT °C	43	5	-7	-11	-14	-16			
INLET EVAP. °C	43	-1	-8	-11	-15	-16.5			
OUTLET EVAP.	43	10	-4	-12	-16	-18			
INLET COND °C	43	87	87	93	93	90			
OUTLET COND °C	43	76	68	67	63	64			
Room °C									

COMPLETION TIME 242 Min No. OF CUT-OUTS- TOTAL OFF TIME-

me									
AMPS.									
WATTS									
Suct. Pressure									
F. C. °C									
P.C.	T. °C								
	T. °C								
	T. °C								
Compressor Shell °C									
Suction Line °C									
Ice Tray °C									
Welding °C									
Bridge Ω									
Room °C									

Research & Development Laboratories

No.3

TEST: PULL DOWN	TEST No. 1617	DATE: MARCH 95
VOLTS: 220 CYC. 50Hz	MODEL No. 6223a	ROOM: 1 STA. 1
CHARGE: R134- 134gr	COMP No.	AMBIENT: 43 C

OVERLOAD .

ISOLATOR ÷ LEADS :		Ro :						To :		ISO . No.	
Time	0 Min	10	25	60	120	244					
AMPS.		1.04	0.97	0.95	0.44	0.91					
WATTS		176	151	149	138	129					
Suct. Pressure											
EVAPORATOR °C	43	32	17	1.7	-5	-8.5					
T. °C	43	42	38	27	14.9	7.7					
CABINET T. °C	43	42	37	26	14.5	7.1					
T. °C	43	41	37	27	16	8.1					
Compressor Shell °C	43	60	81	89	96	97					
Suction Line °C	43	60	50	44	40	41					
THERMOSTAT °C	43	5	-6.5	-10.5	-13.8	-15.8					
INLET EVAP. °C	43	-1	-8	-10.8	-14.8	-16.4					
OUTLET EVAP. °C	43	10	-4	-11.9	-15.8	-17.8					
INLET COND °C	43	88	88	94	94	91					
OUTLET COND °C	43	77	69	68	64	64					
Room °C											

COMPLETION TIME — 244 Min

No. OF CUT-OUTS — TOTAL OFF TIME —

AMPS.										
WATTS										
Suct. Pressure										
F. C. °C										
P.C.	T. °C									
	T. °C									
	T. °C									
Compressor Shell °C										
Suction Line °C										
Ice Tray °C										
Winding °C										
Bridge °C										
Room °C										

Tested By

.88.

Head of Research & Development

Research & Development Laboratories

No. 4

TEST : PULL DOWN	TEST No. 1711	DATE : MARCH
VOLTS : CYC	MODEL No. 6243 a	ROOM : 2 STA. 3
CHARGE : 9134a - 135 gr	COMP No.	AMBIENT : 43 C

OVERLOAD :

ISOLATOR + LEADS :

Ro :

To :

ISO . No.

Time	0 Min	10	25	60	120	245					
AMPS.		1.05	0.98	0.96	0.95	0.92					
WATTS		177	152	150	139	130					
Suct. Pressure											
EVAPORATOR °C	43	33	18	1.7	-5	-8.5					
T. °C	43	47	38	28	14.8	7.8					
CABINET T. °C	43	42	37	27	14.5	7.2					
T. °C	43	42	38	28	15.9	8.2					
Compressor Shell °C	43	61	81	89	97	98					
Suction Line °C	43	61	-51	45	41	42					
THERMOSTAT °C	43	6	-6.9	-10	-13.5	-15.5					
INLET EVAP. °C	43	-0.9	-7.9	-10	-14.5	-16.1					
OUTLET EVAP. °C	43	11	-3.9	-11.5	-15.5	-17.5					
INLET COND °C	43	89	89	95	96	92					
OUTLET COND °C	43	78	70	69	65	66					
Room °C											

COMPLETION TIME 245 Min

No. OF CUT-OUTS _____ TOTAL OFF TIME _____

AMPS.											
WATTS											
Suct. Pressure											
F. C. °C											
P.C.	T. °C										
	T. °C										
	T. °C										
Compressor Shell °C											
Suction Line °C											
Ice Tray °C											
Welding °C											
Bridge 2											
Room °C											

Tested By _____

Head of Research & Development

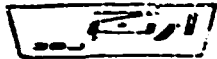

Research & Development Laboratories Performance Sheet

REFRIGERATOR (7 cub. ft)

Cycling Run

No. 1

Room 2	Station 1	Date	March 95	
Test No. 1859	Model 6243a	Ambient °C	43	
Compressor NR75LAEG	Thermostat Ranco	Control Pos.	MID	
Overload	Charge R134a - 130 gr	kwhr Per Day	2	0 4 0
Remarks: Compressor Gold star - 1/8 hp		Avg. Cab. Air °C	9.6/ 5.10	
		Percent Run	6	5 %
		Average Watts	8	5
		Cycles Per Day	35	
12	1	570	56	1331
11		514		1246
Actual Clock Time	Elapsed Time	Turning Time Clock	Running Time	Kwhr Meter
				Kwhr/Elapsed Time
		Suction C.I.		
		Pressure C.O.		
		Discharge Press.		
		Barometer	658 mm Hg	

Time		Out	in								AVG.
EVAPORATOR	°C	-10.1	-9.8								
CABINET	T.	°C	5.2	2.4							
	T.	°C	4.8	1.81							
	T.	°C	4.8	4.4							
Compressor Shell	°C	89	6.3								
Suction Line	°C	45									
Thermostat	°C	-11.7									
Evap. highest Point	°C										
Top Egg Shell	°C										
Bottom Egg Shell	°C										
Dairy	°C										
Crisper	°C										
Inlet-Evap.	°C	-18.1	-4.7								
Outlet-Evap.	°C	-21.1	-5.2								
Inlet-Cond.	°C	7.6	4.8								
Outlet-Cond.	°C	5.9	5.1								
Middle Point-Cond.	°C										
Room	°C	43	43								

Tested By :

Head of Research & Development

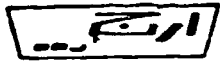

Research & Development Laboratories Performance Sheet

REFRIGERATOR (7 Cub ft) Cycling Run

No.2

Room 2	Station 3	Date	MARCH 95																										
Test No. 1629	Model 6243a	Ambient °C	43																										
Compressor NR 45LAEG	Thermostat Ranco	Control Pos.	MID																										
Overload	Charge R134a 132 gr	kwhr Per Day	2	1 1 2																									
Remarks: Compressor Gold Star 1/8 Hp		Avg. Cab. Air °C	10.2 / 5.26																										
<table border="1" style="width: 100%; border-collapse: collapse; text-align: center;"> <tr> <td style="width: 10%;"></td> <td style="width: 15%;"></td> <td style="width: 15%;"></td> <td style="width: 15%;"></td> <td style="width: 15%;"></td> <td style="width: 10%;"></td> </tr> <tr> <td>10</td> <td>i</td> <td>882</td> <td>56</td> <td>1305</td> <td>88</td> </tr> <tr> <td>9</td> <td></td> <td>826</td> <td></td> <td>1217</td> <td></td> </tr> <tr> <td>ACTUAL Clock Time</td> <td>Elapsed Time</td> <td>RUNNING Time Clock</td> <td>Running Time</td> <td>Kwhr Meter</td> <td>Kwhr/ Elapsed Time</td> </tr> </table>								10	i	882	56	1305	88	9		826		1217		ACTUAL Clock Time	Elapsed Time	RUNNING Time Clock	Running Time	Kwhr Meter	Kwhr/ Elapsed Time	Percent Run	6	4	%
		10	i	882	56	1305	88																						
		9		826		1217																							
		ACTUAL Clock Time	Elapsed Time	RUNNING Time Clock	Running Time	Kwhr Meter	Kwhr/ Elapsed Time																						
		Average Watts	8	8																									
		Cycles Per Day	87																										
		Suction °C																											
		Pressure C.O.																											
		Discharge Press-																											
Barometer	658 mmHg																												

Time		lit	ou	lit	in										AVG.
EVAPORATOR	°C	-10.9		-9.9											
CABINET	T ₁	°C	0.92		2.5										
	T ₂	°C	7.3		1.42										
	T ₃	°C	7.3		1.85										
Compressor Shell	°C	95.7		83.5											
Suction Line	°C	41		39											
Thermostat	°C	-19.5		6.9											
Evap. highest Point	°C														
Top Egg Shell	°C														
Bottom Egg Shell	°C														
Dairy	°C														
Crisper	°C														
Inlet-Evap.	°C	-18.8		-4.9											
Outlet-Evap.	°C	-21.6		-5.9											
Inlet-Cond.	°C	74		44											
Outlet-Cond.	°C	56		48											
Middle Point-Cond.	°C														
Room	°C	43		43											
INLET OC															
OUTLET OC															

Tested By :

Head of Research & Development

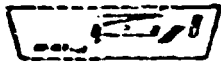

Research & Development Laboratories Performance Sheet

REFRIGERATOR (7 cub ft)

Cycling Run

No.3

Room 2	Station 2	Date March 95	
Test No. 1621	Model 6243	Ambient °C 43	
Compressor NR45LAEG	Thermostat Ranco	Control Pos. MID	
Overload	Charge R134a 134gr	kwhr Per Day 2 0 6 4	
Remarks: Compressor Gold star 1/8 hp		Avg. Cab. Air °C 9.9 / 5.6	
		Percent Run 6 5 %	
		Average Watts 8 6	
		Cycles Per Day 86	
		Suction C.I.	
		Pressure C.O.	
		Discharge Press.	
		Barometer 658mm Hg	

10	1	1008	56	775	86
9		952		689	
Actual Clock Time	Elapsed Time	Running Time Clock	Running Time	Kwhr Meter	Kwhr/Elapsed Time

Time	°C	Cut	cut	in	AVG.
EVAPORATOR	°C	-11	-9.1		
CABINET	T, °C	0.95	2.7		
	T, °C	7.4	1.45		
	T, °C	90	82		
Compressor Shell	°C	41	38		
Suction Line	°C				
Thermostat	°C				
Evap. highest Point	°C				
Top Egg Shell	°C				
Bottom Egg Shell	°C				
Dairy	°C				
Crisper	°C				
Inlet-Evap.	°C	-19.9	-4.1		
Outlet-Evap.	°C	-21.7	5.5		
Inlet-Cond.	°C	76	42		
Outlet-Cond.	°C	62	47		
Middle Point-Cond.	°C				
Room	°C	43	43		

Tested By :

Head of Research & Development

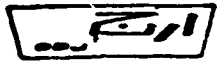

Research & Development Laboratories Performance Sheet

REFRIGERATOR (7 cub.ft)

Cycling Run

No.4

Room 2	Station 3	Date March 95																									
Test No. 1629	Model 6243a	Ambient °C 43																									
Compressor NR45LAEG	Thermostat RANCO	Control Pos. MID																									
Overload	Charge R134a- 135 gr	kwhr Per Day 2 1 1 2																									
Remarks: Compressor Gold star - 1/8 hp		Avg. Cab. Air °C 9.8/ 5.26																									
<table border="1" style="width: 100%; border-collapse: collapse;"> <tr> <td style="width: 15%;"></td> <td style="width: 15%;"></td> <td style="width: 15%;"></td> <td style="width: 15%;"></td> <td style="width: 15%;"></td> <td style="width: 15%;"></td> </tr> <tr> <td>10</td> <td>1</td> <td>882</td> <td>56</td> <td>1305</td> <td>83</td> </tr> <tr> <td>9</td> <td></td> <td>826</td> <td></td> <td>1217</td> <td></td> </tr> <tr> <td>Actual Clock Time</td> <td>Elapsed Time</td> <td>Running Time Clock</td> <td>Running Time</td> <td>Kwhr Meter</td> <td>Kwhr/Elapsed Time</td> </tr> </table>								10	1	882	56	1305	83	9		826		1217		Actual Clock Time	Elapsed Time	Running Time Clock	Running Time	Kwhr Meter	Kwhr/Elapsed Time	Percent Run 6 4 %	
10	1	882	56	1305	83																						
9		826		1217																							
Actual Clock Time	Elapsed Time	Running Time Clock	Running Time	Kwhr Meter	Kwhr/Elapsed Time																						
		Average Watts 8 8																									
		Cycles Per Day 87																									
		Suction C.I.																									
		Pressure C.O.																									
		Discharge Press.																									
		Barometer 658 mm Hg																									

Time		Cut out	Cut in								AVG.
EVAPORATOR	°C	-10	-9.1								
	T.	°C	0.87	0.23							
CABINET	T.	°C	7.20	7.35							
	T.	°C	7.6	1.65							
Compressor Shell	°C	41	39								
Suction Line	°C										
Thermostat	°C										
Evap. highest Point	°C										
Top Egg Shell	°C										
Bottom Egg Shell	°C										
Dairy	°C										
Crisper	°C										
Inlet-Evap.	°C	-17.2	-4.8								
Outlet-Evap.	°C	-18.7	-5.0								
Inlet-Cond.	°C	77	47								
Outlet-Cond.	°C	60	47								
Middle Point-Cond.	°C										
Room	°C	43	43								

Tested By :

Head of Research & Development



Prototype No.1

Ice Freeze Performance Sheet	
Model	6243a
Compressor Power	1/8 hp - NR45 LAEG
Ambient	32 °c
Thermostat	Shorted
Volts /Amper	220 V/0.89A
Percentage working	Contincus
Freezer air	-12.1 °c
Cabinet mean Temp.	5.2 °c
Compressor Shell Temp.	83 °c
Inlet Cond.Temp.	76 °c
Outlet Cond.Temp.	52 °c

Remarks : Within 4 hours & 10 minutes Ice Temp. reached to -7c



Prototype No.2

Ice Freeze Performance Sheet	
Model	6243a
Compressor Power	1/8 hp - NR45 LAEG
Ambient	32 °c
Thermostat	Shorted
Volts /Amper	220 V/0.89A
Percentage working	Continuous
Freezer air	-12.1 °c
Cabinet mean Temp.	5.2 °c
Compressor Shell Temp.	83 °c
Inlet Cond.Temp.	77 °c
Outlet Cond.Temp.	53 °c

Remarks : Within 4 hours & 11 minutes Ice Temp. reached to -7°C



Prototype No.3

Ice Freeze Performance Sheet	
Model	6243a
Compressor Power	1/8 hp - NR45 LAEG
Ambient	32 °c
Thermostat	Shorted
Volts /Amper	220 V/ 0.93 A
Percentage working	Continous
Freezer air	-12.1 °c
Cabinet mean Temp.	5.2 °c
Compressor Shell Temp.	84 °c
Inlet Cond.Temp.	77 °c
Outlet Cond.Temp.	54 °c

Remarks : Within 4 hours & 12 minutes Ice Temp. reached to -7°c



Prototype No. 4

Ice Freeze Performance Sheet	
Model	6243a
Compressor Power	1/8 hp - NR45 LAEG
Ambient	32 °c
Thermostat	Shorted
Volts /Amper	220 V/0.90A
Percentage working	Continous
Freezer air	-12.1 °c
Cabinet mean Temp.	5.2 °c
Compressor Shell Temp.	85 °c
Inlet Cond Temp.	77 °c
Outlet Cond.Temp.	53 °c

Remarks : Within 4 hours & 13 minutes Ice Temp. reached to -7°C



شرکت ارج سازمان ARJ CORPORATION

MODEL 620a

طرح شماره: ۱۳۸۱ - ۱۳۸۲ - ۱۳۸۳ - ۱۳۸۴ - ۱۳۸۵ - ۱۳۸۶ - ۱۳۸۷ - ۱۳۸۸ - ۱۳۸۹ - ۱۳۹۰ - ۱۳۹۱ - ۱۳۹۲ - ۱۳۹۳ - ۱۳۹۴ - ۱۳۹۵ - ۱۳۹۶ - ۱۳۹۷ - ۱۳۹۸ - ۱۳۹۹ - ۱۴۰۰



CALCULATION AND EQUIPMENT SELECTION FOR MODEL 6202a

TRANSMISSION LOAD

Cabinet constant $C = p / (t_1 - t_a)$

$C = 20 / (38 - 19) = 1.02$ measured in lab.

$A_{fo} = 36416 \text{ cm}^2$

$A_{ri} = 26160 \text{ cm}^2$

$A_m = \sqrt{A_i * A_o}$

$A_m = 3.2864 \text{ m}^2$

Therefore transmission load at inside Temp. (-18 °C) for three star freezer will be :

$Q_t = U * A * DT$

$Q_t = C * DT$

$Q_t = 1.02 [43 - (-18)]$

$Q_t = 62.21 \text{ watt}$

PRODUCTION LOAD

$Q_{pd} = \sum Q_{pf} + \sum Q_{1f} + \sum Q_{1k}$

Where

Q_{pf} = Heat removed from product to freezer product from initial temperature to freezing point

$Q_{pf} = W * C * DT$

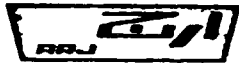

No.	product	Weight Kg	Freezing Temp.	Initial Temp.	Final Temp.	CP after freezing	CP before freezing
1	Poaltry	5	-2.75 °c	28 °c	-18 °c	1.55 kj/kg °k	3.18 kj/kg °k
2	Beef	6	-0.5 °	28	-18	1.67 kj/kg °k	3.14 kj/kg °k
3	Fish	4	-2.25 °	15	-18	1.72 kj/kg °k	3.64 kj/kg °k
4	Vegetable	3	-1.25 °	15	-18	1.97 kj/kg °k	3.64 kj/kg °k

$$Q_{pf(po)} = 5 \times 3.18 [28 - (-2.75)] = 489 \text{ kj}$$

$$Q_{pf(be)} = 6 \times 3.14 [28 - (-0.5)] = 537 \text{ "}$$

$$Q_{pf(fi)} = 4 \times 3.18 [15 - (-2.25)] = 325 \text{ "}$$

$$Q_{pf(veg)} = 3 \times 3.64 [15 - (-1.25)] = 179 \text{ "}$$

$$Q_{pf} = 1528.40 \text{ kj}$$

Q_{lf} = Heat removed to freezer product

$$Q_{lf(po)} = 5 \times 1.55 [-2.75 - (-18)] = 160 \text{ Kj}$$

$$Q_{lf(be)} = 6 \times 1.67 [-0.5 - (-18)] = 185 \text{ "}$$

$$Q_{lf(fi)} = 4 \times 1.72 [-2.25 - (-18)] = 139.5 \text{ "}$$

$$Q_{lf(veg)} = 3 \times 1.97 [-1.25 - (-18)] = 114 \text{ "}$$

$$Q_{lf} = 598.2 \text{ kj}$$

$$Q_{lk} = W \cdot h_i$$

Where

Q_{lk} = Heat removed to freeze Product

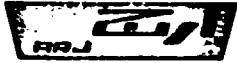

$$\begin{aligned} h_i(\text{po}) &= 246 \text{ kJ/kg}^\circ\text{K} \\ h_i(\text{be}) &= 288 \text{ " } \\ h_i(\text{fi}) &= 235 \text{ " } \\ h_i(\text{veg}) &= 277 \text{ " } \\ Q_{1k}(\text{po}) &= 5 \times 246 = 1230 \text{ kJ} \\ Q_{1k}(\text{be}) &= 6 \times 228 = 1368 \text{ " } \\ Q_{1k}(\text{fi}) &= 4 \times 235 = 940 \text{ " } \\ Q_{1u}(\text{veg}) &= 3 \times 277 = 831 \text{ " } \\ Q_{1k} &= 4369 \text{ kJ} \\ Q_{pd} &= Q_{pf} + Q_{1f} + Q_{1k} \\ Q_{pd} &= 6495 + 598 + 4369 = 6495 \text{ kJ} \\ &= 6495 / 16 \times 3600 = 112.75 \text{ watt} \end{aligned}$$

COOLING CAPACITY OF COMPRESSOR

$$\begin{aligned} Q_{cc} &= Q_t + Q_{pd} + Q_a \\ Q_{cc} &= (62.21 + 112.75) \times 1.1 = 191 \text{ watt} \\ Q_{cc} &= 165 \text{ k cal/h} \end{aligned}$$

CONDENSER'S POWER DETERMINATION

$$\text{As we know} \quad k_s = \frac{S(\text{kcal/h}) \times 1.25}{DT}$$

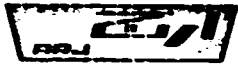

Operational condition

$$a) \quad K_s = \frac{165 \times 1.25}{55-43} = 17.53 \text{ k cal/h k}$$

$$b) \quad K_s = \frac{165 \times 1.25}{55-32} = 8.96 \text{ k cal/h k}$$

According to static wired condenser series 55-51-635 (page 209)

the suitable dimension of condenser is taken.

No of legs : 24

The wide of condenser : 572 mm

The lenght of condenser : 1179 mm

CAPILLARY'S CAPACITY DETERMINATION

Asuming mass flow rate of compressor 3.45 k cal/h

Evap.Temp. -23.3 c the specific volume of vapour is $0.171 \text{ m}^3 / \text{kg}$

at condensing Temp. 55 c the pressure is 14.9 kg/cm^2 (see page 205)

$$V_a = 3.45 \times 0.171 \times 1000/60$$

$$V_a = 9.83 \text{ L/min}$$

$$V_a = 2.35 \sqrt{\frac{p^{-1}}{14.9^{-1}}} \cdot 2.5^{-0.5} * L$$

$$9.66 = 2.35 \sqrt{\frac{1}{14.9}} \cdot 0.79 * L$$

$$L = 3.88 \text{ meter}$$

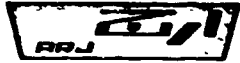

EVAPORATOR DETERMINATION

As we know that

$$Q_{cc} = Q_{ev}$$

Q_{cc} = Cooling capacity of compressor

Q_{ev} = Cooling capacity of evaporator

$$Q_{cc} = U * A * DT$$

Where

$$Q_{cc} = 165 \text{ kcal/h}$$

U = Coefficient of heat transmission $4.7 \text{ w/m}^2 \text{ k}$

A = Surface area of evaporator m^2

DT = Different temperature between evaporator Temp. and compartment

Therefore

$$165 = 4.7 * A * 11.3$$

$$A = 3.10 \text{ m}^2$$

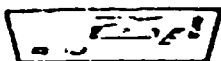

Research & Development Laboratories Performance Sheet

Freezer (10 cu.ft)

Continuous Run at 220 V

No. 1

Room 1	Station 2	Date April 95	
Test No. 1016	Model 6202a	Ambient °C 43	
Compressor V75	Thermostat Danfoss	Control Pos. MAX. (Short)	
Overload	Charge R134a 170 gr	kwhr Per Day 4 0 8 0	
Remarks: Compressor Gold Star 1/4 hp		Avg. Cdb/Air °C -21.2	
		Percent Run 1 0 0 %	
		Average Watts 1 7 0	
		Cycles Per Day	
		Suction C.I.	
		Pressure C.O.	
		Discharge Press.	
		Barometer 650mm Hg	
10	2	10 31	200
8		8 31	620
Actual Clock Time	Eapsed Time	Running Time Clock	Running Time Meter
			kwhr/Elapsed Time 340

Time																			AVG.
Cabinet	T ₁	°C	-18.4																
	T ₂	°C	-22																
	T ₃	°C	-22																
	T ₄	°C	-22.6																
Compressor Shell		°C	89.1																
Suction Line		°C	39																
Thermostat		°C	-20																
Evap. highest Point		°C																	
Top Egg Shelf		°C																	
Bottom Egg Shelf		°C																	
Dairy		°C																	
Crisper		°C																	
Inlet-Evap.		°C	-14																
Outlet-Evap.		°C	-12																
Inlet-Cond.		°C	61.5																
Outlet-Cond.		°C	56																
Middle Point-Cond.		°C	-																
Room		°C	43																
Inlet OC		°C	80																
Outlet OC		°C	58																

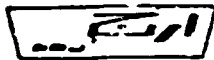

Research & Development Laboratories Performance Sheet

FREEZER (10 Cu.ft.)

Continuous Run

No. 2

Room	1	Station	4	Date	April 95			
Test No.	1729	Model	6202 a	Ambient °C	43			
Compressor	V75	Thermostat	DANFOSS	Control Pos.	MAX. (short)			
Overload		Charge	R134a 172gr	kwhr Per Day	4	0	9	2
Remarks:	Compressor Gold star-1/4 hp			Avg. Cab. Air °C	-21.4			
				Percent Run	1	0	0	%
				Average Watts	1	7	1	
				Cycles Per Day				
				Suction C.I.				
				Pressure C.O.				
				Discharge Press-				
				Barometer	658 mm Hg			
10	2	132i	200	1151				
8		1121		840				
Actual Clock Time	Elapsed Time	Running Time Clock	Running Time	Kwhr Meter	Kwhr/Elapsed Time			

Time																			AVG.
CABINET	T1	°C	-18.4																
	T2	°C	-22																
	T3	°C	-22.6																
	T4	°C	-22.6																
Compressor Shell	°C	90																	
Suction Line	°C	41																	
Thermostat	°C	-20																	
Evap. highest Point	°C																		
Top Egg Shell	°C																		
Bottom Egg Shell	°C																		
Dairy	°C																		
Crisper	°C																		
Inlet-Evap.	°C	-14																	
Outlet-Evap.	°C	-12																	
Inlet-Cond.	°C	62																	
Outlet-Cond.	°C	56																	
Middle Point-Cond.	°C																		
Room	°C	43																	
INLET OC		81																	
OUTLET OC		59																	

Tested By :

Head of Research & Development

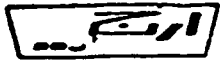

Research & Development Laboratories Performance Sheet

FREEZER (10 Cub. ft)

Continuous Run

No.3

Room 2	Station 3	Date	April 95	
Test No. 1236	Model 6202 a	Ambient °C	43	
Compressor V75	Thermostat DANFOSS	Control Pos.	MAX (short)	
Overload	Charge R134a 175g	kwhr Per Day	4	1
Remarks: Compressor Gold star 1/4 hp		Avg. Cab. Air °C	-21.17	
		Percent Run	1	0
		Average Watts	1	7
		Cycles Per Day		
		Suction C.I.		
		Pressure C.O.		
		Discharge Press-		
		Barometer	658 mm Hg	

	Elapsed Time	Running Time Clock	Running Time	Kwhr Meter	Kwhr/Elapsed Time
12	2	841	200	1455	342
10		691		1113	
Actual Clock Time					

Time		°C								AVG.
CABINET	T1	°C	-18.3							
	T2	°C	-21.9							
	T3	°C	-22							
	T4	°C	-22.5							
Compressor Shell		°C	90							
Suction Line		°C	41							
Thermostat		°C	-19.8							
Evap. highest Point		°C								
Top Egg Shell		°C								
Bottom Egg Shell		°C								
Dairy		°C								
Crisper		°C								
Inlet-Evap.		°C	-13.94							
Outlet-Evap.		°C	-12.94							
Inlet-Cond.		°C	63							
Outlet-Cond.		°C	57							
Middle Point-Cond.		°C								
Room		°C	43							
INLET OC		c	81							
OUTLET OC		c	60							

Tested By :

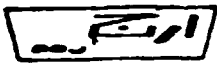

Research & Development Laboratories Performance Sheet

FREEZER (10 Cu.ft)

Continuous Run

No.4

Room 1	Station 3	Date	April 95	
Test No. 1411	Model 6202 a	Ambient °C	23	
Compressor V75	Thermostat DANFOSS	Control Pos.	MAX. (short)	
Overload	Charge R134 178 gr	kwhr Per Day	4	1
Remarks: Compressor GOLD star 1/4 hp		Avg. Cab. Air °C	-21.12	
		Percent Run	1	0
		Average Watts	1	7
		Cycles Per Day	3	
		Suction C.I.		
		Pressure C.O.		
		Discharge Press.		
		Barometer	658 mm Hg	

12	2	112i	200	902	345
10	Elapsed Time	Running Time Clock	Running Time	Kwhr Meter	Kwhr/Elapsed Time

Time			AVG.
CABINET	T1 °C	-18.3	
	T2 °C	-21.8	
	T3 °C	-21.9	
	T4 °C	-22.5	
Compressor Shell °C	90		
Suction Line °C			
Thermostat °C	-19.8		
Evap. highest Point °C			
Top Egg Shell °C			
Bottom Egg Shell °C			
Dairy °C			
Crisper °C			
Inlet-Evap. °C	-13.9		
Outlet Evap. °C	-13.8		
Inlet-Cond. °C	64		
Outlet-Cond. °C	59		
Middle Point-Cond. °C			
Room °C	43		
INLET OC	81		
OUTLET OC	61		

Tested By

Head of Research & Development

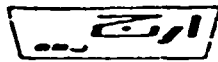

Research & Development Laboratories Performance Sheet

No. 5

FREEZER (10 cu.ft.)

Continuous Run

Room 2	Station 1	Date	Sept. 1995	
Test No. 1081	Model 6202a	Ambient °C	32	
Compressor 1/5	Thermostat Danfoss	Control Pos.	Short	
Overload	Charge R134a 170 gr	kwhr Per Day	3	7 2 0
Remarks: COMPRESSOR GOLD STAR 1/4 hp		Avg. Cab. Air °C	-25.4	
		Percent Run	1	0 0 0
		Average Watts	1	5 5
		Cycles Per Day		
		Suction C.I.		
		Pressure C.O.		
		Discharge Press-		
		Barometer	658 mm Hg	

9	2	418G1	200	62741	310
7		416U1		62431	
Actual Clock Time	Elapsed Time	Running Time Clock	Running Time	Kwhr Meter	Kwhr/Elapsed Time

Time									AVG.
	°C								
Cabinet	T.	°C	-18.4						
	T.	°C	-22						
	T.	°C	-22.6						
Compressor Shell	°C	74.1							
Suction Line	°C								
Thermostat	°C	-26.3							
Evap. highest Point	°C								
Top Egg Shell	°C								
Bottom Egg Shell	°C								
Dairy	°C								
Crisper	°C	-16.2							
Inlet-Evap.	°C	-14.8							
Outlet-Evap.	°C	48.6							
Inlet-Cond.	°C	41.5							
Outlet-Cond.	°C								
Middle Point-Cond.	°C								
Room	°C	32							

Tested By _____

Head of Research & Development

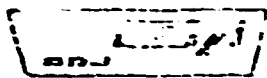

Research & Development Laboratories

Freezer (10 cu.ft)

No. 1

TEST: Pull Down	TEST No. 1017	DATE: April 95
VOLTS: 220 CYC. 50Hz	MODEL No. 6202a	ROOM: 43°C STA. 4
CHARGE: R134a -170gr	COMP No.	AHSIENT: 43°C

ISOLATOR + LEADS :		Re :		To :		ISO . No.	
Time	0	10 Min.	25	60	120	180	
AMPS.	-	1.37	1.47	1.22	1.07	1.07	
WATTS	-	250	275	220	180	175	
Suct. Pressure	-	-	-	-	-	-	
Cabinet	T ₁ °C	43	41	24.8	-1.8	-15	-18.9
	T ₂ °C	43	39	21.1	-2.9	-15.6	-19
	T ₃ °C	43	38	21.3	-2.6	-15.6	-19
	T ₄ °C	43	30.4	14.1	-3.8	-16	-19.5
Compressor Shell °C	43	56	76	92	91.3	89.7	
Suction Line °C	43	50	49	41	39.2	37.9	
Temostat °C	43	40	23	-7.1	-16	-18	
Inlet Evap. °C	43	5.2	7.2	-1.3	-7	-8.1	
Outlet Evap. Ω	43	36	23	-5	-9.4	-11	
Inlet Cond.	43	64	68	67	64	63	
Outlet Cond.	43	61	64	62	59	57	
Inlet OC	43	76	91	95	86	83	
Outlet OC	43	64	66.6	63	59	58	
Room °C	43	43	43	43	43	43	

COMPLETION TIME: 180 Mins. No. OF CUT-OUTS: _____ TOTAL OFF TIME: _____

me							
AMPS.							
WATTS							
Suct. Pressure							
F. C. °C							
P.C.	T ₁ °C						
	T ₂ °C						
	T ₃ °C						
Compressor Shell °C							
Suction Line °C							
Ice Tray °C							
Winding °C							
Bridge Ω							
Room °C							

Tested by

Head of Research & Development

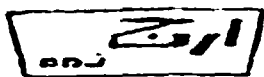

Research & Development Laboratories

No. 2

TEST: PULL DOWN	TEST No. 1027	DATE: APRIL 95
VOLTS: 220 CYC. 50 Hz	MODEL No. 6202 a	ROOM: 1 STA. 2
CHARGE: R134a - 172 gr	COMP No.	AMBIENT: 43 °C

OVERLOAD :

ISOLATOR + LEADS :

Ro :

Tc :

ISO . No.

Time	0 Min	10	25	60	120	182					
AMPS.		1.38	1.47	1.73	1.07	1.08					
WATTS		250	275	297	150	176					
Suct. Pressure											
CABINET	T ₁ °C	43	41	24.8	-1.3	-15	-18.8				
	T ₂ °C	43	39	21.1	-2.9	-15.9	-19				
	T ₃ °C	43	38	21.1	-2.6	-15.5	-19				
	T ₄ °C	43	31	14	-3.8	-15	-19.4				
Compressor Shell °C	43	56	76	92	92	90					
Suction Line °C	43	50	50	42	40	38					
THERMOSTAT °C	43	40	23	-7	-16	-18					
INLET EVAP. °C	43	5.2	7.1	-1.3	-7	-8					
OUTLET EVAP.	43	36	23	-5	-9.3	-11					
INLET COND °C	43	64	68	67	65	64					
OUTLET COND °C	43	61	64	62	60	58					
	43	76	91	96	85	83					
	43	64	67	64	60	59					
Room °C	43	43	43	43	43	43					

COMPLETION TIME 182 Min

No. OF CUT-OUTS TOTAL OFF TIME

AMPS.											
WATTS											
Suct. Pressure											
F. C. °C											
P.C.	T ₁ °C										
	T ₂ °C										
	T ₃ °C										
Compressor Shell °C											
Suction Line °C											
Ice Tray °C											
Winding °C											
Bridge Ω											
Room °C											

Tested By

-111-

Head of Research & Development

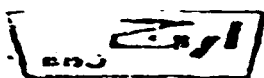

Research & Development Laboratories

No. 3

TEST: PULL DOWN	TEST No. 11297	DATE: APRIL 95
VOLTS: 220 CYC. 50 Hz	MODEL No. 6202 a	ROOM: 2 STA. 3
CHARGE: R134-175 gr	COMP No.	AMBIENT: 43 C

OVERLOAD:

ISOLATOR ÷ LEADS:		Ro:						To:		ISO. No.	
Time	0 Min	10	25	60	120	185					
AMPS.		1.38	1.48	1.24	1.08	1.09					
WATTS	43	251	276	222	181	177					
Suct. Pressure											
CABINET	T ₁ °C	43	42	25	-1.8	-15	-18.8				
	T ₂ °C	43	40	21.2	-2.8	-15.5	-18.9				
	T ₃ °C	43	39	22	-2.5	-15.5	-18.9				
	T ₄ °C	43	33	14	-3.7	-16	-19.4				
Compressor Shell °C	43	57	77	92	92	90					
Suction Line °C	43	51	50	42	40	39					
THERMOSTAT °C	43	41	24	-7	-15.9	-17.8					
INLET EVAP. °C	43	5.3	7.1	-1.2	-6.4	-8					
OUTLET EVAP.	43	37	24	-5	-9.2	-10.9					
INLET COND °C	43	65	68	67	64	65					
OUTLET COND °C	43	62	65	63	60	58					
INLET OC	43	77	92	96	87	84					
OUTLET OC	43	65	67	65	61	60					
Room °C	43	43	43	43	43	43					

COMPLETION TIME 183 Min No. OF CUT-OUTS _____ TOTAL OFF TIME _____

AMPS.										
WATTS										
Suct. Pressure										
F. C. °C										
P.C.	T ₁ °C									
	T ₂ °C									
	T ₃ °C									
Compressor Shell °C										
Suction Line °C										
Ice Tray °C										
Welding °C										
Bridge	2									
Room °C										

Tested by

Head of Research & Development

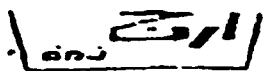

Research & Development Laboratories

NO 4

TEST: PULL DOWN	TEST No. 1297	DATE: APRIL 95
VOLTS: 220 CYC. 50 Hz	MODEL No. 6202 a	ROOM: 3 STA. 3
CHARGE: R134a-178 gr	COMP No.	AMBIENT: 43 c

OVERLOAD:

ISOLATOR + LEADS:

Re:

To:

ISO. No.

Time	0 Min	10	25	60	120	189							
AMPS.		1.4	1.49	1.25	1.09	1.10							
WATTS		255	290	230	205	180							
Suct. Pressure													
CABINET	T ₁ °C	43	42	25	-1.8	-15	-18.8						
	T ₂ °C	43	40	21.3	-2.8	-15.8	-18.9						
	T ₃ °C	43	40	23	-2.6	-15.5	-18.9						
	T ₄ °C	43	33	15	-3.6	-15.9	-19.2						
Compressor Shell °C	43	58	78	92	93	91							
Suction Line °C	43	52	51	42	41	40							
THERMOSTAT °C	43	42	25	-7	-15.8	-17.8							
INLET EVAP. °C	43	5.3	7.1	-1.2	-6.9	-8							
OUTLET EVAP. °C	43	37	24	-5	-9.2	-10.9							
INLET COND °C	43	65	68	67	64	65							
OUTLET COND °C	43	62	65	63	60	58							
INLET OC	43	77	92	96	87	84							
OUTLET OC	43	65	67	65	61	60							
Room °C	43	43	43	43	43	43							

COMPLETION TIME ~~189~~ Min

No. OF CUT-OUTS _____ TOTAL OFF TIME _____

AMPS.																				
WATTS																				
Suct. Pressure																				
F. C. °C																				
P.C.	T ₁ °C																			
	T ₂ °C																			
	T ₃ °C																			
Compressor Shell °C																				
Suction Line °C																				
Ice Tray °C																				
Winding °C																				
Bridge 2																				
Room °C																				

Tested by:

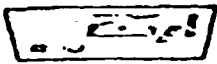

Research & Development Laboratories Performance Sheet

Freezer (10cu.ft)

Cycling Run

No.1

Room	1	Station	4	Date	April 95			
Test No.	1018	Model	6202a	Ambient °C	43			
Compressor	V75	Thermostat	Ranco	Control Pos.	MID.			
Overload		Charge	R134a 170gr	kwhr Per Day	3	2	4	9
Remarks:	Compressor Gold Star 1/4 hp			Avg. Cab. Air °C	-15.9			
				Percent Run	8	2	%	
				Average Watts				
				Cycles Per Day	33			
10	2	229	164	Suction C.I.				
8		65	500	Pressure C.O.				
Actual Clock Time	Elapsed Time	Stopping Time Clock	Running Time	kwhr Meter	kwhr/Elapsed Time			
				Discharge Press.				
				Barometer	658 mm Hg			

Time		Cut out	Cut in												AVG.	
Cabinet	T1 °C	-15.7	15.2													
	T2 °C	-16.5	16.1													
	T3 °C	-16	15.7													
	T4 °C	-16.1	15.8													
Compressor Shell °C		84	82.1													
Suction Line °C		37	20													
Thermostat °C		-20	-14													
Evap. highest Point °C																
Top Egg Shelf °C																
Bottom Egg Shelf °C																
Dairy °C																
Crisper °C																
Inlet-Evap. °C		-14.2	-11													
Outlet-Evap. °C		-12.1	-10.1													
Inlet-Cond. °C		62.5	58													
Outlet-Cond. °C		55	54													
Middle Inlet-Cond. °C																
Room °C		43														
Inlet OC °C		79	71													
Outlet OC °C		57	56													

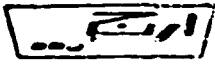

Research & Development Laboratories Performance Sheet

FREEZER (10 Cu ft)

Cycling Run

No.2

Room 2	Station 4	Date	APRIL 95	
Test No. 1897	Model 6202a	Ambient °C	43	
Compressor V75	Thermostat DANFOSS	Control Pos.	MID	
Overload	Charge R134a 172gr	kwhr Per Day	3	2
Remarks: Compressor Gold star - 1/4 hp		Avg. Cab. Air °C	6	4
		Percent Run	6	8
		Average Watts	1	3
		Cycles Per Day	34	
		Suction C.I.		
		Pressure C.O.		
		Discharge Press-		
		Barometer	658 mm Hg	
12	2	1078	186	1303
10		892		1031
Actual Clock Time	Elapsed Time	Running Time Clock	Running Time	Kwhr/Meter
				Kwhr/Elapsed Time

Time	cut	out	cut	in							AVG.
CABINET	T1	°C	-15.7	-15.1							
	T2	°C	-16.5	-16.1							
	T3	°C	-16	-15.7							
	T4	°C	-16	-15.8							
Compressor Shell	°C	84	83								
Suction Line	°C	38	21								
Thermostat	°C										
Evap. highest Point	°C										
Top Egg Shell	°C										
Bottom Egg Shell	°C										
Dairy	°C										
Crisper	°C										
Inlet-Evap.	°C	-14.2	-11								
Outlet-Evap.	°C	-12	-10.1								
Inlet-Cond.	°C	63	58								
Outlet-Cond	°C	56	54								
Middle Point-Cond	°C										
Room	°C	43	43								
INLET OC	°C	79	72								
OUTLET OC	°C	58	56								

Tested By :

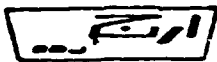

Research & Development Laboratories Performance Sheet

FREEZER

10 Cu.ft

Cyclins Run

No. 3

Room 1	Station 3	Date APRIL 95	
Test No. 1961	Model 6202 a	Ambient °C 43	
Compressor V75	Thermostat DANFOSS	Control Pos. MID	
Overload	Charge R134a-175gr	kwhr Per Day 3 2 8 5	
Remarks: Compressor Gold star -1/4 hp		Avg. Cab. Air °C -16	
		Percent Run 6 7 %	
		Average Watts 1 3 7	
		Cycles Per Day 35	
		Section C.I.	
		Pressure C.O.	
		Discharge Press.	
		Barometer 658 mm Hg	

12	2	607	184	1715	274
10	Elapsed Time	Running Time Clock	Running Time	Kwhr Meter	Kwhr/Elapsed Time

Time	out	out	cut in							AVG.
CABINET	T ₁	°C	-15.6	-15						
	T ₂	°C	-16.5	-16						
	T ₃	°C	-16	-15.6						
	T ₄	°C	-15.9	-15.7						
Compressor Shell	°C	85	83							
Suction Line	°C	39	22							
Thermostat	°C									
Evap. highest Point	°C									
Top Egg Shell	°C									
Bottom Egg Shell	°C									
Dairy	°C									
Crisper	°C									
Inlet-Evap.	°C	-14.1	-10.9							
Outlet-Evap.	°C	-11.9	-10							
Inlet-Cond.	°C	64	58							
Outlet-Cond.	°C	57	55							
Middle Point-Cond.	°C									
Room	°C	43	43							
INLET OC	°C	79	72							
OUTLET OC	°C	58	56							

Tested By :

Head of Research & Development

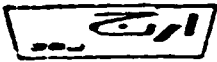

Research & Development Laboratories Performance Sheet

FREEZER (10 cub.ft)

Cycling Run

No. 4

Room 2	Station 4	Date	April 95	
Test No. 2131	Model 6202a	Ambient °C	43	
Compressor V 75	Thermostat Danfoss	Control Pos.	MID	
Overload	Charge R134a - 178gr	kwhr Per Day	3	3 1 2
Remarks: Compressor Gold Star - 1/4hp		Avg. Cab. Air °C	-15.95	
		Percent Run	6	7 %
		Average Watts	1	3 3
		Cycles Per Day		
		Suction C.I.		
		Pressure C.O.		
		Discharge Press.		
		Barometer	656 mm Hg	

12	2	886	185	2003	276
10	701	1727	Kwhr/ Elapsed Time		
Actual Clock Time	Elapsed Time	Running Time Clock	Raising Time	Kwhr Meter	Elapsed Time

Time		Cutout	Cutin						AVG.
CABINET	T ₁	°C	15.5	-15					
	T ₂	°C	-16.5	-16					
	T ₃	°C	-16	-15.6					
	T ₄	°C	-15.9	-15.8					
Compressor Shell		°C	86	84					
Suction Line		°C	40	22					
Thermostat		°C							
Evap. highest Point		°C							
Top Egg Shell		°C							
Bottom Egg Shell		°C							
Dairy		°C							
Crisper		°C							
Inlet-Evap.		°C	-14	-10.9					
Outlet-Evap.		°C	-11.8	-10					
Inlet-Cond.		°C	65	60					
Outlet-Cond.		°C	59	57					
Middle Point-Cond.		°C							
Room		°C	43	43					
INLET OC		°C	80	74					
OUTLET OC		°C	60	58					

Tested By :



Prototype No.1

Temp.rise test Performance sheet	
Model	6202a
Compressor Power	1/4 hp - V75 LAEG
Ambient	32 °c
Thermostat position	Normal
Volts /Amper	220 V/1.35A
Percentage working	-
Freezer air	-
Cabinet mean Temp.	-
Compressor Sheet Temp.	-
Inlet Cond.Temp.	-
Outlet Cond.Temp.	-

Remarks : 11 hours and 50 minutes is taken for the first package to reach -9 °c from -18 °c.



Prototype No.2

Temp.rise test Performance sheet	
Model	6202a
Compressor Power	1/4 hp - V75 LAEG
Ambient	32 °c
Thermostat position	Normal
Volts /Amper	220 V/1.35A
Percentage working	-
Freezer air	-
Cabinet mean Temp.	-
Compressor Sheet Temp.	-
Inlet Cond.Temp.	-
Outlet Cond.Temp.	-

Remarks : 11 hours and 51 minutes is taken for the first package to reach -9 °c from -18 °c.

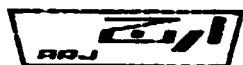

Prototype No.3

Temp.rise test Performance sheet	
Model	6202a
Compressor Power	1/4 hp - V75 LAEG
Ambient	32 °c
Thermostat position	Normal
Volts /Amper	220 V/1.35A
Percentage working	-
Freezer air	-
Cabinet mean Temp.	-
Compressor Sheet Temp.	-
Inlet Cond.Temp.	-
Outlet Cond.Temp.	-

Remarks : 11 hours and 51 minutes is taken for the first package to reach -9 °c from -18 °c.



Prototype No. 4

Temp. rise test Performance sheet	
Model	6202a
Compressor Power	1/4 hp - V75 LAEG
Ambient	32 °c
Thermostat. position	Normal
Volts /Amper	220 V/1.35A
Percentage working	-
Freezer air	-
Cabinet mean Temp.	-
Compressor Sheet Temp.	-
Inlet Cond.Temp.	-
Outlet Cond.Temp.	-

Remarks : 11 hours and 52 minutes is taken for the first package to reach -9 °c from -18 °c.



Prototype No. 1

Frozen food storage test Performance Sheet	
Model	6202a
Compressor Power	1/4 hp - V75 LAEG
Ambient	43 °c
Thermostat	Short
Volts /Amper	220 V/1.36A
Percentage working	Continous
Freezer air	-19.5a
Cabinet mean Temp.	-18.2 °c
Compressor Sheet Temp.	-89.2 °c
Inlet Cond.Temp.	62 °c
Outlet Cond.Temp.	57 °c

Remarks: 90 Kg test load.
After 24 hours all Temp. were at -18 °c



Prototype No.2

Frozen food storage test Performance Sheet	
Model	6202a
Compressor Power	1/4 hp - V75 LAEG
Ambient	43 °c
Thermostat	Short
Volts /Amper	220 V/1.36A
Percentage working	Continous
Freezer air	-19.5 °c
Cabinet mean Temp.	-18.2 °c
Compressor Sheet Temp.	-89.2 °c
Inlet Cond.Temp.	62 °c
Outlet Cond.Temp.	57 °c

Remarks: 90 Kg test load.
After 24 hours all Temp. were at -18 °c



Prototype No.3

Frozen food storage test Performance Sheet	
Model	6202a
Compressor Power	1/4 hp - V75 LAEG
Ambient	43 °c
Thermostat	Short
Volts /Amper	220 V/1.36A
Percentage working	Continous
Freezer air	-19.5 °c
Cabinet mean Temp.	-18.1 °c
Compressor Sheet Temp.	-89.4 °c
Inlet Cond.Temp.	63 °c
Outlet Cond.Temp.	58 °c

Remarks: 90 Kg test load.
After 24 hours all Temp. were at -18 °c



Prototype No.4

Frozen food storage test Performance Sheet	
Model	6202a
Compressor Power	1/4 hp - V75 LAEG
Ambient	43 °c
Thermostat	Short
Volts /Amper	220 V/1.36A
Percentage working	Continous
Freezer air	-19.4 °c
Cabinet mean Temp.	-18.1 °c
Compressor Sheet Temp.	-89.5 °c
Inlet Cond.Temp.	63 °c
Outlet Cond.Temp.	59 °c

Remarks: 90 Kg test load.
After 24 hours all Temp. were at -18 c

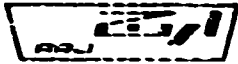

Prototype No.1

Freezing power test Performance Sheet	
Model	6202a
Compressor Power	1/4 hp - V75 LAEG
Ambient	32 °c
Thermostat	SHORT
Volts /Amper	220 V/1.38A
Percentage working	Continous
Freezer air	-
Cabinet mean Temp.	-
Compressor Shell Temp.	78 °C
Inlet Cond.Temp.	50 °C
Outlet Cond.Temp.	46 °C

Remarks : It is loaded with 12 Kg and reached from 30 °c to - 18 °c in 23.5 hours & 30 minutes.

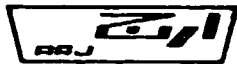

Frctotype No.2

Freezing power test Performance Sheet	
Model	6202a
Compressor Power	1/4 hp - V75 LAEG
Ambient	32 °c
Thermostat	SHORT
Volts /Amper	220 V/1.38A
Percentage working	Continous
Freezer air	-
Cabinet mean Temp.	-
Compressor Shell Temp.	78 °C
Inlet Cond.Temp.	50 °C
Outlet Cond.Temp.	46 °C

Remarks : It is loaded with 12 Kg and reached from 30 °c to - 18 °c in 23.5 hours & 30 minutes.



Prototype No.3

Freezing power test Performance Sheet	
Model	6202a
Compressor Power	1/4 hp - V75 LAEG
Ambient	32 °c
Thermostat	SHORT
Volts /Amper	220 V/1.38A
Percentage working	Continous
Freezer air	-
Cabinet mean Temp.	-
Compressor Shell Temp.	73 °C
Inlet Cond.Temp.	50 °C
Outlet Cond.Temp.	46 °C

Remarks : It is loaded with 12 Kg and reached from 30 °c to - 18 °c in 23.5 hours & 32 minutes.

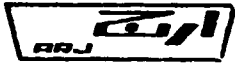

Prototype No.4

Freezing power test Performance Sheet	
Model	6202a
Compressor Power	1/4 hp - V75 LAEG
Ambient	32 °c
Thermostat	SHORT
Volts /Amper	220 V/1.38A
Percentage working	Continous
Freezer air	-
Cabinet mean Temp.	-
Compressor Shell Temp.	78 °c
Inlet Cond.Temp.	50 °c
Outlet Cond.Temp.	46 °c

Remarks : It is loaded with 12 Kg and reached from 30 °c to - 18 °c in 23.5 hours & 34 minutes.



شرکت ارج سرویس
ARJ CORPORATION

MODEL 6249a



CALCULATION AND EQUIPMENT SELECTION FOR MODEL 5249a

For this model there is two different cabinet constant as follows:

$$C = 1.43 \quad \text{w/h} \quad \text{for Refrigerator section}$$

$$C = 1.02 \quad \text{w/h} \quad \text{for Freezer section}$$

The total cooling capacity

$$Qc1 = Qtr + Qpr + Qar \quad \text{for Refrigerator compartment}$$

$$Qc2 = Qtf + Qpf$$

$$Qcc = Q1 + Q2$$

Where

Qtr = transmission heat relative to refrigerator compartment.

Qrf = transmission heat relative to freezer compartment.

Qpr = production load in refrigerator compartment

Qpf = production load in freezer compartment

Qa = Air changing load.

TRANSMISSION LOAD

$$Qtr = U * A * DT$$

$$C = U * A$$

$$Qtr = 1.43 * (43-5)$$

$$Qtr = 55 \text{ watt}$$

$$Qtf = 1.02 * [43 - (-18)]$$



Q_tf = 63 watt

Q_t = 118 watt

PRODUCTION LOAD

For the freezer compartment

Q_{pd} = ΣQ_{pf} + ΣQ_{lf} + ΣQ_{lk} + ΣQ_{pr}

Q_{pf} = W * C_p * DT

Q_{pf} = Heat removed from products from initial Temp. to freezing point.

Where *****

W = Average product weight per kg

Product	Weight	Freezing point	C _p before freezing	C _p after freezing	Initial Temp.	Final Temp.
Poultry	6 Kg	-2.75 °c	3.18 kj/kg k	1.55 kj/kg k	28 °c	-18 °c
Fish	4 kg	-2.25 °c	3.18 kj/kg k	1.72 kj/kg k	15 °c	-18 °c

Q_{pf1} = 6 x 3.18 [28-(-2.75)] = 586.7 kj for poultry

Q_{pf2} = 4 x 3.18 [15-(-2.25)] = 326 kj for fish

Q_{pf} = 611.7 kj

Q_{lf} = Heat removed to Freezer product

Q_{lf1} = 6 x 1.5 [-2.75-(-18)] = 192.9 kj for poultry

Q_{lf2} = 4 x 1.72 [-2.25-(-18)] = 140 kj for fish

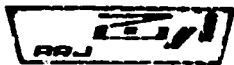

Q_{if} = 332.9 kj

Q_{lk} = W * h_i

Where

Q_{lk} = Heat removed to Freeze product

Q_{lk(me)} = 6 x 246 = 1476 kj

Q_{lk(fi)} = 4 x 235 = 940 kj

Q_{lk} = 2416 kj

Therefore

Q_{pdf} = Q_{pf} + Q_{if} + Q_{lk}

Q_{pdf} = 611.7 + 732.9 + 2416

Q_{pdf} = 3360 kj

For the refrigerator compartment.

Q_{pr} = Heat removed from product above Freezing point

Q_{pr} = W * C_p * DT

No.	Product	Specific heat	Weight Kg	Initial Temp.	Final Temp.°c
1	Meat	3.14 kj/kg °k	4	28 °c	5 °c
2	Butter	2.68 "	3	10	5
3	Vegetable	3.77 "	4	20	10
4	Fruit	3.81 "	6	20	10
5	Water	4.18 "	3	20	10
6	Milk	3.76 "	2	10	5

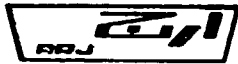

$$\begin{aligned}
 Q_{pr1} &= 4 \times 3.14 (28-5) = 288.8 \text{ kj} \\
 Q_{pr2} &= 3 \times 2.68 (10-5) = 40.2 \text{ ''} \\
 Q_{pr3} &= 4 \times 3.77 (20-10) = 150.8 \text{ ''} \\
 Q_{pr4} &= 6 \times 3.81 (20-10) = 228.6 \text{ ''} \\
 Q_{pr5} &= 3 \times 4.18 (20-10) = 125.4 \text{ ''} \\
 Q_{pr6} &= 2 \times 3.76 (10-5) = 37.6 \text{ ''} \\
 Q_{pdr} &= 571.4 \text{ Kj}
 \end{aligned}$$

Therefore

The total production load will be :

$$Q_{pd} = 3360 + 871.4 = 4231.4 \text{ Kj}$$

Now the cooling capacity will be :

$$Q_{cc} = (118 + 73.4) \times 1.09 = 209 \text{ watt}$$

CONDENSER'S POWER DETERMINATION

We know that

$$k_s = \frac{S(\text{k cal/h}) \times 1.25}{\Delta T}$$

Operational condition

$$a) \quad k_s = \frac{180 \times 1.25}{55-43} = 18.75 \text{ kcal/h}^\circ\text{k}$$



$$b) \quad ks = \frac{180 \times 1.25}{55-32} = 9.78 \quad \text{kcal/hk}$$

According to static wired condenser series 51-51-635 (see page 209)

The suitable dimension of condenser will be :

No of legs : 24

The wide of condensor : 612 mm

The lenght of condensor : 1179 mm

CAPILLARY'S CAPACITY DETERMINATION

Assuming mass flow rate of compressor 3.45 kg/h

at Evaporating Temp. -23.3 c the specific volume of vapour

is 0.171 m³/kg (see page 203)

at condensing Temp. 55 c the pressure is 14.9 kg/cm² (see page 205)

$$Va = 3.45 \times 0.171 \times 1000/60$$

$$Va = 9.83 \quad \text{L/min}$$

$$Va = 2.35 \sqrt{\frac{2}{p-1}} * a^{2.5} * L^{-0.5}$$

$$9.66 = 2.35 \sqrt{\frac{2}{14.9-1}} * 0.79 * L^{-0.5}$$

$$L = 3.83 \quad \text{meter}$$

EVAPORATOR DETERMINATION

As we know that

$$Q_{cc} = Q_{ev}$$

Q_{cc} = Cooling capacity of compressor



Q_{ev} = Cooling capacity of evaporator

$$Q = U * A * DT$$

Where

$$Q_{cc} = 180 \text{ kcal/h}$$

$$U = \text{Heat transmission coefficient } 4.7 \text{ W/m}^2 \text{ k}$$

A = Surface area of evaporator

DT = Difference temp. between evaporator and compartment

$$180 = 4.7 * A * 5.3$$

$$A = 7.22 \text{ m}^2$$

This surface are including for both freezer and refrigerator.

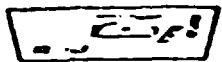

Research & Development Laboratories

Performance Sheet

Continuous Run at 220 V

No. 1

Room 1		Station -2		Date		April 95			
Test No. 1002		Model 6249a		Ambient °C		43			
Compressor ESC 9HK		Thermostat:		Control Pos.		MAX.			
Overload		Charge R134a 165 gr		Kwhr Per Day		4 8 0 0			
Remarks: Compressor Necchi - 1/4 hp						Avg. Cab. Air °C		-19.1/3.5	
						Percent Run		1 0 0 %	
						Average Watts		2 0 0	
						Cycles Per Day			
						Suction C.I.			
						Pressure C.D.			
						Discharge Press.			
						Barometer		658 mmHg	
10	2	1002	200	773	400				
8	Elapsed Time	802	Running Time	373	Kwhr/Elapsed Time				
Actual Clock Time		Running Time Clock		Kwhr Meter					

Time																			AVG.
Evaporator	°C	-19.1																	
Cabinet	T ₁	°C	3.6																
	T ₂	°C	3.3																
	T ₃	°C	3.6																
Compressor Shell	°C	84.7																	
Suction Line	°C	41.5																	
Thermostat	°C	-18.4																	
Evap. highest Point	°C																		
Top Egg Shell	°C																		
Bottom Egg Shell	°C																		
Dairy	°C																		
Crisper	°C																		
Inlet-Evap.	°C	-20.3																	
Outlet-Evap.	°C	-18																	
Inlet-Cond.	°C	73																	
Outlet-Cond.	°C	56																	
Middle Part Cond.	°C																		
Room	°C																		
Inlet OC	°C	68																	
Out let OC	°C	59.4																	

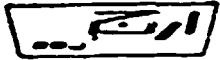

Research & Development Laboratories Performance Sheet

Two door Ref./Freezer

Continuous Run

No. 2

Room 2		Station 4		Date April 95	
Test No. 1196		Model 5249a		Ambient °C 43	
Compressor ESC9HK		Thermostat Danfoss		Control Pos. Max (short)	
Overload		Charge R134a 168 gr		kwhr Per Day 4 8 4 8	
Remarks: COMPRESSOR NECCHI - 1/4 hp					
				Avg. Cab. Air °C -19.1 / 3.45	
				Percent Run 1 0 0 %	
				Average Watts 2 0 2	
				Cycles Per Day	
				Section C.I.	
				Pressure C.O.	
				Discharge Press.	
				Barometer 658 mm Hg	
12	2	1141	200	1439	404
10		941		1039	
Actual Clock Time	Elapsed Time	Running Time Clock	Running Time	kwhr Meter	kwhr/Elapsed Time

Time																					AVG.
EVAPORATOR	°C	-19.1																			
CABINET	T.	°C	3.6																		
	T.	°C	3.2																		
	T.	°C	3.6																		
Compressor Shell	°C	85																			
Suction Line	°C	42																			
Thermostat	°C	-18.4																			
Evap. highest Point	°C																				
Top Egg Shelf	°C																				
Bottom Egg Shelf	°C																				
Dairy	°C																				
Crisper	°C																				
Inlet-Evap.	°C	-20.2																			
Outlet-Evap.	°C	-18.1																			
Inlet-Cond.	°C	73																			
Outlet-Cond.	°C	57																			
Middle Point-Cond.	°C																				
Room	°C	43																			
INLET OC	°C	68																			
OUTLET OC	°C	60																			

Tested By :

Head of Research & Development

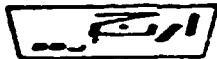

Research & Development Laboratories Performance Sheet

Two door Ref./Freezer

Continuous Run

No.3

Room	2		Station	3		Date	April 95			
Test No.	1210		Model	6249 a		Ambient °C	43			
Compressor	ESC9HK		Thermostat	Danfoss		Control Pos.	Max (short)			
Overload			Charge	R134a 170gr		kwhr Per Day	4	8	0	0
Remarks: COMPRESSOR NECCHI 1/4 hp						Avg. Cab. Air °C	-19.1 / 3.45			
						Percent Run	1	0	0	%
						Average Watts	2	0	2	
						Cycles Per Day				
						Section C.I.				
						Pressure C.O.				
						Discharge Press.				
						Barometer	658 mm Hg			
Actual Clock Time	Elapsed Time	Running Time Clock	Running Time	kwhr Meter	kwhr/Elapsed Time					
12	2	922	200	826	405					
10		722		421						

Time																	AVG.	
EVAPORATOR	°C	-19.1																
CABINET	T.	°C	3.6															
	T.	°C	3.2															
	T.	°C	3.6															
Compressor Shell	°C	85																
Suction Line	°C	42																
Thermostat	°C	-18.4																
Evap. highest Point	°C																	
Top Egg Shelf	°C																	
Bottom Egg Shelf	°C																	
Dairy	°C																	
Crisper	°C																	
Inlet-Evap.	°C	-20.1																
Outlet-Evap.	°C	-18.3																
Inlet-Cond.	°C	73																
Outlet-Cond.	°C	58																
Middle Point-Cond.	°C																	
Room	°C	43																
INLET OC	°C	68																
OUTLET OC	°C	61																

Tested By :

Head of Research & Development



Research & Development Laboratories

Performance Sheet

Continuous Run

No. 4

Two door Ref/ Freezer

Room	2		Station	1		Date	April 95			
Test No.	1380		Model	6249 a		Ambient	°C 43			
Compressor	ESC9HK		Thermostat	Danfoss		Control Pos.	Max (short)			
Overload			Charge	R134a 172 gr		kwhr Per Day	4	8	7	2
Remarks:	Compressor Necchi - 1/4hp									
						Avg. Cab. Air	°C -19.1/3.45			
						Percent Run	1	0	0	2
						Average Watts	2	0	3	
						Cycles Per Day				
						Section	C.I.			
						Pressure	C.O.			
						Discharge Press.				
						Barometer	658 mm Hg			

ACTUAL Clock Time	Elapsed Time	Running Time Clock	Running Time	Kwhr Meter	Kwhr/Elapsed Time
10:08	2	1531	200	907	406
8		1331		501	

Time															AVG.	
EVAPORATOR	°C	-19.1														
CABINET	T ₁	°C	3.6													
	T ₂	°C	3.3													
	T ₃	°C	3.5													
Compressor Shell	°C	86														
Suction Line	°C	42														
Thermostat	°C	-18.4														
Evap. highest Point	°C															
Top Egg Shell	°C															
Bottom Egg Shell	°C															
Dairy	°C															
Crisper	°C															
Inlet-Evap.	°C	-20.2														
Outlet-Evap.	°C	-18.3														
Inlet-Cond.	°C	73														
Outlet-Cond.	°C	58														
Middle Point-Cond.	°C															
Room	°C	43														
INLET OC	°C	68														
OUTLET OC	°C	61														

Tested by :



Research & Development Laboratories Performance Sheet

Two door Ref. / Freezer

Continuous Run

No. 5

Room	1	Station	2	Date	Sept 1995			
Test No.	1 92	Model	6249a	Ambient	°C	32		
Compressor	ESC9HK	Thermostat	Danfoss	Control Pos.	Max. (short)			
Overload		Charge	R134a 165gr	kwhr Per Day	4	5	1	2
Remarks:	COMPRESSOR NECCHI 1/4 hp			Avg. Cab. Air	°C	-22.8 / -2.8		
				Percent Run	1	0	0	%
				Average Watts	1	8	8	
				Cycles Per Day				
				Section	C.I.			
				Pressure	C.D.			
				Discharge Press.				
				Barometer	653 mm Hg			
10	2	2410	200	4388	376			
8		2210		4012				
Actual Clock Time	Elapsed Time	Running Time Clock	Running Time	Kwhr Meter	Kwhr/Elapsed Time			

Time										AVG.
EVAPORATOR	°C	-22.8								
CABINET	T.	°C	-1.8							
	T.	°C	-2.8							
	T.	°C	-1.2							
Compressor Shell	°C	78								
Suction Line	°C	32								
Thermostat	°C	-20.3								
Evap. highest Point	°C									
Top Egg Shelf	°C									
Bottom Egg Shelf	°C									
Dairy	°C									
Crisper	°C									
Inlet-Evap.	°C	-21.2								
Outlet-Evap.	°C	-20.8								
Inlet-Cond.	°C	65								
Outlet-Cond.	°C	52								
Middle Point-Cond.	°C									
Room	°C	32								

Tested By :

Eng. of Research & Development



TEST: Pull down	TEST NO: 1005	DATE: April 95
VOLTS: 220 CYC: 50Hz	MODEL No: 6249a	ROOM: 2 STA: 1
CHARGE: R134a - 165 gr	COMP No:	AMBIENT: 43°C

OVERLOAD :									
ISOLATOR + LEADS :									
	Re :			To :				ISO . No.	
Time	0	10Min	25	60	120	240	244		
AMPS	-	1.75	1.77	1.72	1.70	1.67	1.55		
WATTS	-	245	255	240	235	210	200		
Suct. Pressure	-	-	-	-	-	-	-		
Evaporator °C	43	42.3	25.7	-4.6	-13.9	-16.6	-17.2		
Cabinets	T ₁ °C	43	43	42	34.4	21	9.5	7	
	T ₂ °C	43	42.6	42	34.3	20.9	9.3	6.8	
	T ₃ °C	43	43	42.6	35.5	21.2	10.2	7.6	
	T ₄ °C	43	43	42.6	35.5	21.2	10.2	7.6	
Compressor Shell °C	43	55.4	73	86	88.4	86.9	86		
Suction line °C	43	49.6	53	49	46	43.7	43.2		
Thermostat °C	43	40.4	33.3	-1.9	-11	-15.4	-16.4		
Inlet. Evap. °C	43	-10.2	-12	-16	-18.2	-20.3	-20.6		
Outlet. Evap. °C	43	36.2	32	11.2	2.60	-1.7	-2.8		
Inlet Cond.	43	60	66	70	71	70	70		
Outlet Cond.	43	58.7	65	65	62	60	61		
Inlet OC	43	64	78	82	81	77	77		
Outlet OC	43	57	62	62	60	59	59		
Room °C	43	43	43	43	43	43	43		

COMPLETION TIME: 244 Min No. OF CUT-OUTS: TOTAL OFF TIME:

me									
AMPS									
WATTS									
Suct. Pressure									
F. C. °C									
P.C.	T ₁ °C								
	T ₂ °C								
	T ₃ °C								
Compressor Shell °C									
Suction line °C									
Ice Tray °C									
Winding °C									
Bridge 2									
Room °C									

TEST: PULL DOWN	TEST No. 1002	DATE: APRIL 95
VOLTS: 220 CYC. 50Hz	MODEL No. 6249 a	ROOM: 1 STA. 3
CHARGE: R134a - 167 gr	COMP No.	AMBIENT: 43 C

OVERLOAD:

ISOLATOR ÷ LEADS:

Ro:

To:

ISO . No.

Time	0 Min	10	25	60	120	240	246				
AMPS.		1.75	1.77	1.72	1.70	1.67	1.58				
WATTS		245	255	240	235	210	201				
Suct. Pressure											
CABINET	T ₁ °C	43	42.3	25.7	-4.6	-13.9	-16.6	-17.2			
	T ₂ °C	43	43	42	35	21	10	7			
	T ₃ °C	43	43	42	35	21	9.7	6.9			
	T ₄ °C	43	43	43	36	21.5	10.7	7.7			
Compressor Shell °C	43	56	73	86	89	87	86				
Suction Line °C	43	50	54	49	46	44	43.5				
THERMOSTAT °C	43	41	34	-1.9	-11	-15.3	-16.3				
INLET EVAP. °C	43	-11	-12	-16	-18	20.3	-20.5				
OUTLET EVAP.	43	36	32	11.2	2.6	-1.7	-2.8				
INLET COND °C	43	60	66	70	72	70	70				
OUTLET COND °C	43	59	65	65	63	60	61				
INLET OC	43	64	78	82	81	77	77				
OUTLET OC	43	57	62	62	61	59	60				
Room °C	43	43	43	43	43	43	43				

COMPLETION TIME 246 Min

No. OF CUT-OUTS _____

TOTAL OFF TIME _____

AMPS.											
WATTS											
Suct. Pressure											
F. C. °C											
P.C.	T ₁ °C										
	T ₂ °C										
	T ₃ °C										
Compressor Shell °C											
Suction Line °C											
Ice Tray °C											
Welding °C											
Bridge 2											
Room °C											

Tested By _____

Head of Research & Development

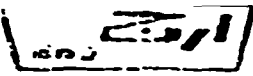

TEST: PULL DOWN	TEST No. 1129	DATE: APRIL 95
VOLTS: 220 CYC. 50Hz	MODEL No. 6249 a	ROOM: 2 STA. 2
CHARGE: R134 a - 170gr	COMP No.	AMBIENT: 43 C

OVERLOAD :

ISOLATOR + LEADS :		Ro :		To :		ISO No.		
Time	0 Min	10	25	60	120	240	247	
AMPS.		1.76	1.77	1.73	1.71	1.67	1.57	
WATTS		226	256	241	235	211	202	
Suct. Pressure								
CABINET	T ₁ °C	43	43	26	-4.5	-13.7	-16.5	-17.1
	T ₂ °C	43	43	41	35	22	11	8
	T ₃ °C	43	43	42	36	22	10.4	6.8
	T ₄ °C	43	44	43	36	21.4	10.5	7.7
Compressor Shell °C		43	57	43	87	89	86	87
Suction Line °C		43	50	54	49	47	44	44
THERMOSTAT °C		43	42	34	-1.9	-11	-15.2	-16.3
INLET EVAP. °C		43	-11	-12	-16	-18	-20.2	-20.5
OUTLET EVAP.		43	36	33	11.1	2.6	-1.7	-2.8
INLET COND °C		43	61	67	71	73	71	71
OUTLET COND °C		43	60	66	66	63	61	62
INLET OC		43	64	83	83	83	78	78
OUTLET OC		43	58	63	63	62	60	61
Room °C		43	43	43	43	43	43	43

COMPLETION TIME 247 Min. No. OF CUT-OUTS _____ TOTAL OFF TIME _____

AMPS.									
WATTS									
Suct. Pressure									
F. C. °C									
P.C.	T ₁ °C								
	T ₂ °C								
	T ₃ °C								
Compressor Shell °C									
Suction Line °C									
Ice Tray °C									
Welding °C									
Bridge	2								
Room °C									

TEST: PULL DOWN	TEST No. 1469	DATE: APRIL 95
VOLTS: 220 CYC. 50Hz	MODEL No. 6249a	ROOM: 2 STA. 3
CHARGE: R134 a 174 gr	COMP No.	AMBIENT: 43 C

OVERLOAD :

ISOLATOR + LEADS :		Ro :				To :		ISO . No.			
Time	0 Min	10	25	60	120	240	250				
AMPS.		1.76	1.77	1.73	1.71	1.67	1.59				
WATTS		246	256	241	235	211	203				
Suct. Pressure											
EVAPORATOR °C	43	42	26	-4.5	-13.7	-16.5	-17.1				
CABINET	T ₁ °C	43	43	41	35	22	11	8			
	T ₂ °C	43	43	42	36	22	10.4	6.8			
	T ₃ °C	43	44	43	36	21.4	10.5	7.7			
Compressor Shell °C	43	57	73	87	89	88	87				
Suction Line °C	43	51	54	49	47	44	49				
THERMOSTAT °C	43	42	34	-1.9	-11	-15.2	-16.3				
INLET EVAP. °C	43	-11	-12	-16	-18	-20.2	-20.5				
OUTLET EVAP.	43	36	33	11.1	2.6	-1.7	-2.8				
INLET COND °C	43	61	67	71	73	71	71				
OUTLET COND °C	43	60	66	66	63	61	62				
	43	64	78	83	83	73	78				
	43	59	63	63	62	60	61				
Room °C	43	43	43	43	43	43	43				

COMPLETION TIME 250 Min

No. OF CUT-OUTS TOTAL OFF TIME

AMPS.											
WATTS											
Suct. Pressure											
F. C. °C											
P.C.	T ₁ °C										
	T ₂ °C										
	T ₃ °C										
Compressor Shell °C											
Suction Line °C											
Ice Tray °C											
Welding °C											
Bridge 2											
Room °C											

Tested By

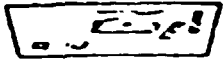

Research & Development Laboratories

Performance Sheet

Cycling Run

Tow doors ref/freezer

Room	3	Station	4	Date	April 95			
Test No.	1010	Model	6249a	Ambient °C	43			
Compressor	ESC 9HK	Thermostat	Ranco	Control Pos.	MID.			
Overload		Charge	R134a 165 gr	Kwhr Per Day	4	2	6	0
Remarks:	Compressor Necchi			Avg. Cab. Air °C	-15.5/6			
				Percent Run	8	4	%	
				Average Watts	2	1	1	
				Cycles Per Day	24			
12	4	9-37	3-36	Suction C.I.				
8		6-01		Pressure C.O.				
Actual Clock Time	Elapsed Time	Waiting Time Clock	Running Time	Kwhr Meter	710			
				Kwhr/Elapsed Time				
				Discharge Press.				
				Bartometer	658mm Hg			

Time	Cut out	Cut in																	AVG.
Evaporator °C	-16.5	-14.8																	
Cabinet	T ₁ °C	5.2	6.9																
	T ₂ °C	5.0	6.5																
	T ₃ °C	5.7	7																
Compressor Shell °C	84.2	74.3																	
Suction Line °C	42.4	38.2																	
Thermostat °C	-17.3	2.2																	
Evap. highest Point °C																			
Top Egg Shelf °C																			
Bottom Egg Shelf °C																			
Dairy °C																			
Crisper °C																			
Inlet-Evap. °C	-20.8	12.4																	
Outlet-Evap. °C	-17.2	18.1																	
Inlet-Cond. °C	67.5	44																	
Outlet-Cond. °C	60	47																	
Middle Point Cond. °C	-	-																	
Room °C	43	43																	
Inlet oc °C	75.7	44																	
Outlet oc °C	57.3	43																	

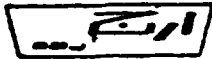

Research & Development Laboratories Performance Sheet

TWO DOOR

REF/FREEZER

CYCLING RUN

No.2

Room 1	Station 2	Date	APRIL 95	
Test No. 2214	Model 6249a	Ambient °C	43	
Compressor ESC 9HK	Thermostat DANFOSS	Control Pos.	MID	
Overload	Charge R134a 168gr	kwhr Per Day	4	2
Remarks: Compressor Necchi 1/4 hp		Avg. Cab. Air °C	-15.5	5.2
		Percent Run	7	9
		Average Watts	1	7
		Cycles Per Day	25	
		Suction C.I.		
		Pressure C.O.		
		Discharge Press.		
		Barometer		

12	2	769	148	1590	179
10	2	621	148	1411	179
Actual Clock Time	Elapsed Time	Running Time Clock	Running Time	Kwhr Meter	Kwhr/Elapsed Time

658 mm Hg

Time	°C	Cut out	Cut in							AVG.
EVAPORATOR	°C	-16.5	-14.8							
CABINET	T.	°C	5.2	6.9						
	T.	°C	5.0	6.5						
	T.	°C	5.6	7.1						
Compressor Shell	°C	85	75							
Suction Line	°C	43	38.5							
Thermostat	°C	-17.3	-1.2							
Evap. highest Point	°C									
Top Egg Shell	°C									
Bottom Egg Shell	°C									
Dairy	°C									
Crisper	°C									
Inlet-Evap.	°C	-20.7	-12.5							
Outlet-Evap.	°C	-17.1	-10.3							
Inlet-Cond.	°C	68	44							
Outlet-Cond.	°C	60	48							
Middle Point-Cond.	°C									
Room	°C	43	43							
INLET OC	°C	76	44							
OUTLET OC	°C	58	43							

Tested By :

Head of Research & Development



Research & Development Laboratories Performance Sheet

TOW DOOR RFF/FREEZER

CYCLING RUN

No.3

Room	2	Station	3	Date	APRIL 95			
Test No.	2014	Model	5249a	Ambient °C	43			
Compressor	ESC 9HK	Thermostat	DANFOSS	Control Pos.	MID			
Overload		Charge	R134a - 168gr	kwhr Per Day	4	3	4	4
Remarks:	Compressor Neccli - 1/4 hp			Avg. Cab. Air °C	-15.5 / 5.2			
				Percent Run	8	2	%	
				Average Watts	1	8	1	
				Cycles Per Day	26			
				Suction C.I.				
				Pressure C.O.				
				Discharge Press.				
				Barometer	658 mmHg			

				1400	181		
12	2	437	149	1219			
10		288					
Actual Clock Time	Elapsed Time	Running Time Clock	Running Time	Kwhr Meter	Kwhr/Elapsed Time		

Time	°C	Cut out	Cut in							AVG.
EVAPORATOR	°C	-16.5	-14.5							
CABINET	T.	°C	5.2	6.9						
	T.	°C	5	6.5						
	T.	°C	5.6	7.1						
Compressor Shell	°C	85	75							
Suction Line	°C	-17.3	-12.1							
Thermostat	°C	-17.2	-12.0							
Evap. highest Point	°C									
Top Egg Shell	°C									
Bottom Egg Shell	°C									
Dairy	°C									
Crisper	°C									
Inlet-Evap.	°C	-20.7	-12.6							
Outlet-Evap.	°C	-17.1	-10.2							
Inlet-Cond.	°C	68	46							
Outlet-Cond.	°C	61	48							
Middle Point-Cond.	°C									
Room	°C	43	43							
INLET OC	°C	76	45							
OUTLET OC	°C	58	44							

Tested By :

Head of Research & Development

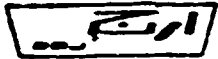

Research & Development Laboratories Performance Sheet

TOW DOOR REF/FRDDZER CYCLING RUN

No. 4

Room 1	Station 1	Date	APRIL 95		
Test No. 2034	Model 6249a	Ambient °C	43		
Compressor ESC 9HK	Thermostat DANFOSS	Control Pos.	MID		
Overload	Charge F R134a-172gr	kwhr Per Day	4	3	
Remarks: Compressor Neccli -1/4 hp		Avg. Cab. Air °C	-15.5	/	5.2
		Percent Run	8	1	%
		Average Watts	1	8	2
		Cycles Per Day	26		
		Suction C.I.			
		Pressure C.O.			
		Discharge Press-			
		Barometer	658 mmHg		

10	2	1160	148	1492	162
8		1012		1310	
Actual Clock Time	Elapsed Time	Running Time Clock	Running Time	Kwhr Meter	Kwhr/Elapsed Time

Time	Cut out	Cut in								AVG.
EVAPORATOR °C	-16.5	-14.5								
CABINET	T. °C	5.2	-4.5							
	T. °C	5.2	6.5							
	T. °C	5.6	7.1							
Compressor Shell °C	86	76								
Suction Line °C	-17.2	-12.2								
Thermostat °C	-17.2	-12								
Evap. highest Point °C										
Top Egg Shell °C										
Bottom Egg Shell °C										
Dairy °C										
Crisper °C										
Inlet-Evap. °C	-20.6	-12.1								
Outlet-Evap. °C	-17.1	-10.2								
Inlet-Cond. °C	68	46								
Outlet-Cond. °C	61	48								
Middle Point-Cond. °C										
Room °C	43	43								
INLET OC °C	76	45								
OUTLET OC °C	58	44								

Tested By :



Prototype No.1

Temp.rise test Performance sheet	
Model	6249a
Compressor Power	1/4 hp - ESC9H
Ambient	32 °c
Thermostat position	Normal
Volts /Amper	220 V/1.38A
Percentage working	-
Freezer air	-
Cabinet mean Temp.	-
Compressor Shell Temp.	-
Inlet Cond.Temp.	-
Outlet Cond.Temp.	-

Remarks : 11 hours and 10 minutes is taken for
the first package to read -9 °c from -18 °c



Prototype No.2

Temp.rise test Performance sheet	
Model	6249a
Compressor Power	1/4 hp - ESC9H
Ambient	32 °c
Thermostat position	Normal
Volts /Amper	220 V/1.38A
Percentage working	-
Freezer air	-
Cabinet mean Temp.	-
Compressor Shell Temp.	-
Inlet Cond.Temp.	-
Outlet Cond.Temp.	-

Remarks : 11 hours and 10 minutes is taken for
the first package to read -9 °c from -18 °c



Prototype No.3

Temp.rise test Performance sheet	
Model	6249a
Compressor Power	1/4 hp - ESC9H
Ambient	32 °c
Thermostat position	Normal
Volts /Amper	220 V/1.38A
Percentage working	-
Freezer air	-
Cabinet mean Temp.	-
Compressor Shell Temp.	-
Inlet Cond.Temp.	-
Outlet Cond.Temp.	-

Remarks : 11 hours and 11 minutes is taken for
the first package to read -9 °c from -18 °c



Prototype No.4

Temp.rise test Performance sheet	
Model	6249a
Compressor Power	1/4 hp - ESC9HK
Ambient	32 °c
Thermostat position	Normal
Volts /Amper	220 V/1.38A
Percentage working	-
Freezer air	-
Cabinet mean Temp.	-
Compressor Shell Temp.	-
Inlet Cond.Temp.	-
Outlet Cond.Temp.	-

Remarks : 11 hours and 12 minutes is taken for
the first package to read -9°c from -18 °c

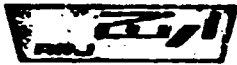

Prototype No.1

Frozen food storage test Performance Sheet	
Model	6249a
Compressor Power	1/4 hp - ESC9HK
Ambient	43 °c
Thermostat	Short
Volts /Amper	220 V/1.12A
Percentage working	Continous
Freezer air	-19 °c
Cabinet mean Temp.	-18 °c
Compressor Sheet Temp.	-84.5 °c
Inlet Cond.Temp.	74 °c
Outlet Cond.Temp.	56 °c

Remarks : 30 Kg test load .
After 24 hours all Temp. reached at -18 °c.

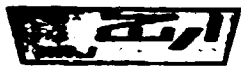

Prototype No.2

Frozen food storage test Performance Sheet	
Model	6249a
Compressor Power	1/4 hp - ESC9HK
Ambient	43 °c
Thermostat	Short
Volts /Amper	220 V/1.12A
Percentage working	Continous
Freezer air	-19 °c
Cabinet mean Temp.	-18 °c
Compressor Sheet Temp.	84.5 °c
Inlet Cond.Temp.	74 °c
Outlet Cond.Temp.	56 °c

Remarks : 30 Kg test load .
After 24 hours all Temp. reached at -18 °c.



Prototype No.3

Frozen food storage test Performance Sheet	
Model	6249a
Compressor Power	1/4 hp - ESC9HK
Ambient	43 °c
Thermostat	Short
Volts /Amper	220 V/1.12A
Percentage working	Continous
Freezer air	-18.6 °c
Cabinet mean Temp.	-19.4 °c
Compressor Sheet Temp.	86.5 °c
Inlet Cond.Temp.	75 °c
Outlet Cond.Temp.	57 °c

Remarks : 30 Kg test load .
After 24 hours all Temp. reached at -18 °c.



Prototype No.4

Frozen food storage test Performance Sheet	
Model	6249a
Compressor Power	1/4 hp - ESC9HK
Ambient	43 °c
Thermostat	Short
Volts /Amper	220 V/1.12A
Percentage working	Continous
Freezer air	-18.6 °c
Cabinet mean Temp.	-19.4 °c
Compressor Sheet Temp.	-86.5 °c
Inlet Cond.Temp.	75 °c
Outlet Cond.Temp.	57 °c

Remarks : 30 Kg test load .
After 24 hours all Temp. reached at -18 °c.



Prototype No.1

Freezing power test Performance Sheet	
Model	6249a
Compressor Power	1/4 hp - ESC9HK
Ambient	32 °c
Thermostat	SHORT
Volts /Amper	220 V/1.39A
Percentage working	Continous
Freezer air	-
Cabinet mean Temp.	-
Compressor Sheet Temp.	84 °C
Inlet Cond.Temp.	74 °C
Outlet Cond.Temp.	65.5 °C

Remarks : It is loaded with 3 Kg and reached from 30 °c to -18 °c in 22 hours & 30 minutes.

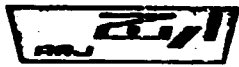

Prototype No.2

Freezing power test Performance Sheet	
Model	6249a
Compressor Power	1/4 hp - ESC9HK
Ambient	32 °c
Thermostat	SHORT
Volts /Amper	220 V/1.39A
Percentage working	Continous
Freezer air	-
Cabinet mean Temp.	-
Compressor Sheet Temp.	84 °C
Inlet Cond.Temp.	74 °C
Outlet Cond.Temp.	65.5 °C

Remarks : It is loaded with 3 Kg and reached from
30 °c to -18 °c in 22 hours & 30 minutes.



Prototype No.3

Freezing power test Performance Sheet	
Model	6249a
Compressor Power	1/4 hp - ESC9HK
Ambient	32 °c
Thermostat	SHORT
Volts /Amper	220 V/1.39A
Percentage working	Continous
Freezer air	-
Cabinet mean Temp.	-
Compressor Sheet Temp.	85 °C
Inlet Cond.Temp.	75 °C
Outlet Cond.Temp.	66.5 °c

Remarks : It is loaded with 3 Kg and reached from 30 °c to -18 °c in 22 hours & 31 minutes.

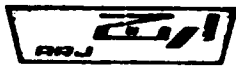

Prototype No.4

Freezing power test Performance Sheet	
Model	6249a
Compressor Power	1/4 hp - ESC9HK
Ambient	32 °c
Thermostat	SHORT
Volts /Amper	220 V/1.39A
Percentage working	Continous
Freezer air	-
Cabinet mean Temp.	-
Compressor Sheet Temp.	85 °c
Inlet Cond.Temp.	75 °c
Outlet Cond.Temp.	67.5 °c

Remarks : It is loaded with 3 Kg and reached from 30 °c to -18 °c in 22 hours & 32 minutes.



COMPRESSOR SELECTION



COMPRESSOR SELECTION FOR DIFFERENT MODELS

The compressor selection for different model is based on available or existing compressor models in Iranian market at present. The following table shows these Compressors selected.

Note : 10% additional load has been considered for Fridge air replacement and infiltration during the day.

Model	Kcal/hr Requirement	Compressor Model selected	Kcal/hr According to ASHRAE
6246a	99.3	NR52	113
6247a	112.8	NR58/Esc7H	124/130
6243a	85	NR45	85
6202a	165	V75	165
6249a	180	Esc9HK	184



TASKS

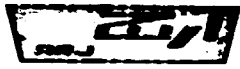

TASKS

After redesign testing and optimization of the plan it was found that the performance of new refrigerat or charged with R134a is almost same as R12 and results have been achived and it was satisfactory . At the present time, there is no problem for the company for mass production . But however the R&D Dept. work hard on the follwoing Items to make the production more efficient which is included.

- * Reduce power consumption
- * Decrease the charging of refrigerant
- * Increase the efficiency of evaporator .



EVALUATION OF PROTOTYPE

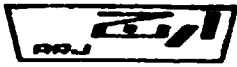

EVALUATION OF PROTOTYPES

Main criteria for redesign

The idea is that for conversion of R12 to R134a to have minor changes and in case if some necessary changes is needed must be considered otherwise the production line of refrigerator & freezer would be involving in many problems .

It is clear that when the refrigerant R12 converts to R134a , the compressor must be designed with consideration of its physical and thermodynamical of new refrigerant properties. But there is no need to bring any change on the design of units.

At the first step ten prototype is made (for each model two) and charged with R134a without any change , of course the different amount of charge for each of five samples of any model. Tests have been carried out under standard condition and finally test result sheets checked out and due to some problem especially, compressor shell Temp. and energy consumption some changes brought on refrigeration cycle, in this respect.

The condenser is new designed for each of model by means of increasing the heat transfer area of condenser so as it is clear in following tables number of legs of condenser has increased from 16 rows for R12 to 18 rows for R134a for refrigerators. Similary for freezer and top freezer refrigerator the oil cooling of the condenser has been replaced for the top of condenser.



NEW CONDENSER DIMENSIONAL SPECIFICATION

Condenser	6246a	6247a	6243a	6202a	6249a
Q1	3/16"	3/16"	3/16"	1/4"	1/4"
No of leg	15	18	14	16+8	20+4
Width mm	455.76	455.76	455.76	537.35	537.55
Lenght mm	882	882	674	1188	1188
Volume Cm	86.1	86.1	67.4	326.7	326.7

The test is carried out for different model with new condenser design ,under ISO standard 43°c ambient Temp.



Compressor NR52 LAEG - COMPARING WITH NEW CONDENSER DESIGN

MODEL 6246a	Charge R134	
	16 Rows.cond.	18 Rows Cond.
	139 gr	142 gr
Average cabinet °c	-1	-1.1
Evaporator Temp.°c	-13.5	-13.5
Inlet Evap.Temp.°c	-18.3	-18.4
Outlet Evap.Temp.°c	-17.6	-17.7
Thermostat bulb °c	-19.8	-20.4
Inlet Cond.Temp. °c	86	77
Outlet Cond.Temp.°c	6.5	56
Suction line °c	46.5	39.6
Comp. shell Temp.°c	101.3	96.6
Ambient °c	43	43
Input watt	120.9	120

Remarks : With 18 rows condenser the energy consumption and compressor shell Temp.decreased



Compressor V75 - COMPARING WITH NEW CONDENSER DESIGN

MODEL 6202a	Charge R134a	
	Old.Cond.	New.Cond.
	162 gr	165 gr
Average cabinet Temp.°c	3.2	3.5
Evap.Temp. °c	-19	-19.1
Inlet Evap.Temp.°c	-20.1	-20.3
Outlet Evap.Temp.°c	-19.2	-18
Thermostat bulb °c	-19.3	-18.4
Inlet Cond.Temp. °c	81	73
Outlet Cond.Temp.°c	65.2	56
Suction line °c	47.5	41.5
Comp.shell Temp.°c	98.5	84.7
Ambient °c	43	43
Input watt	211	200

Remarks : The energy consumption and compressor shell Temp. decreased it should be mentioned that for old condenser the oil cooling positioned below condenser and for new condenser the oil cooling positioned for the top of condenser.



Compressor ESC9HK - COMPARING WITH NEW CONDENSER DESIGN

MODEL 6249a	Charge R134a	
	OLD. Cond.	New. Cond.
	165 gr	170 gr
Average cabinet Temp. °c	-	-
Evap. Temp. °c	-22.1	-21.4
Inlet Evap. Temp. °c	-15.1	-14
Outlet Evap. Temp. °c	-13.8	-12
Thermostat bulb °c	-21	-20
Inlet Cond. Temp. °c	68.5	61.5
Outlet Cond. Temp. °c	61.2	56
Suction line °c	44.2	43.5
Comp. shell Temp. °c	96.5	89.1
Ambient. °c	43	43
Input watt	215.1	211

Remarks : The compressor shell Temp. and energy consumption is notable for new condenser oil cooling is positioned on the top of the condenser. And for old condenser the oil cooling positioned for below the condenser.

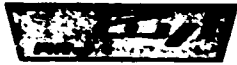

CYCLE COMPARISON



R12 & R134a REFRIGERATION EVALUATION

Compressor ES5H NR 58

		Compressor type	
		ESM 5H	NR 58
		R12	R134a
Evaporating Temp. (-23.3 °c)	bar	1.324	1.167
Condensing pressure (54 °c)	bar	13.67	14.90
Compressor capacity	Kcal/hr	109	124
Displacement	Cm ³	5.1	5.8
Specific volume	m ³ /kg	0.2	0.28
Inlet capillary tube Temp.	°c	55	55
Specific volume	l/kg	0.641	0.731
Input	watt	121	130
E.E.R		3.56	3.79

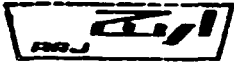

R12 & R134a REFRIGERATION EVALUATION

Compressor FN 43 Vs NR45

		Compressor type	
		FN 43	NR 45
		R12	R134a
Evaporating Temp. (-23.3°c)	bar	1.236	1.168
Condensing pressure (54 °c)	bar	13.66	14.90
Compressor capacity	Kcal/hr	85	93
Displacement	Cm ³	4.3	4.5
Specific volume	m ³ /kg	0.2	0.28
Inlet capillary tube Temp.	°c	55	55
Specific volume	l/kg	0.641	0.731
Input	watt	103	104
E.E.R	-	3.2	3.55



R12 & R134a REFRIGERATION EVALUATION

Compressor V75 (R12) Vs V75 (R134a)

Compressor ESM9HK VS ESC9HK

		Compressor type	
		V 75	V 75
		R12	R134a
Evaporating Temp. (-23.3 °c)	bar	1.236	1.167
Condensing pressure (54 °c)	bar	1.367	14.9
Compressor capacity	Kcal/hr	168	170
Displacement	Cm ³	7.4	7.5
Specific volume	m ³ /kg	0.2	0.28
Inlet capillary tube Temp.	°c	55	55
Specific volume	l/kg	0.642	0.731
Input	watt	175	160
E.E.R	-	3.45	4.23

R12 & R134a TEST SHEETS EVALUATION
Compressor ESM9HK Vs ESC9HK

		Compressor type	
		ESM9HK	ESC9HK
		R12	R134a
Evaporating Temp. (-23.3 °c)	bar	1.236	1.167
Condensing pressure (54 °c)	bar	13.67	14.91
Compressor capacity	Kcal/hr	190	184
Displacement	Cm ³	9	9
Specific volume	m ³ /kg	0.2	0.28
Inlet capillary tube Temp.	°c	55	55
Specific volume	l/kg	0.642	0.731
Input	watt	210	192
E.E.R	-	3.74	3.8



ENERGY CONSUMPTION EVALUATION



ENERGY CONSUMPTION EVALUATION

In this section the energy consumption comparing with respect to new design of condenser for all new models as it is showing in the below tables . The percentage run has rare changes which is almost negligible.

Energy consumption		R12	R134a	Percent Run
Model 6246	FN 51F	65 watt		54%
	NR 52L		66 watt	55
Model 6247	M5	67.2		56
	ESC7H		770	55
Model 6243	Tf4AT	58		58
	NR 45L		65	60
Model 6202	A9HK	119		62
	V75		116	61
Model 6249	A9HK	122		63
	ESC9HK		112.5	60

Note : Test procedure is down at 5 °c for cabinet and 32 °c ambient temperature.



شرکت ارج سبز
ARJ CORPORATION

CONCLUSION



CONCLUSION

The comparison of test result sheets of R134a with R12 shown that. The displacement of R134a compressor increased by some value as well as mass flow rate it means that the compression ratio of R134a is more than for R12.

- * The discharge temperature of R134a is lower than R12 .
- * The volumetric refrigerating effect is almost the same for both refrigerant.
- * The coefficient of performance remains almost the same for both refrigerant.
- * The cooling capacity of the compressor remains almost equivalent.
- * Especial drier XH7 must be used for R134a as a need for high absorption of humidity compared with XH5 for R12.

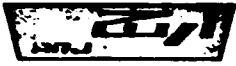

RECOMMENDATION

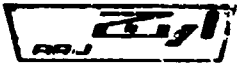

RECOMMENDATIONS

Due to the physical and thermodynamical properties of refrigerant HFC-134a the following point must be taken into consideration, included

- * Cleaness of tubes
- * Evacuation of refrigerator circuit.
- * No humidity in component so it is better to wash out the circuit with N2 at 10 bar , before evacuation and the cap of the compressor must be also taken out just before necessary operation . The limit time recommended by the manufacturers is 10 minutes.
- * No mixing for different type compressor oil, because the R134a type compressor oil is not compatible with mineral oil.
- * Good house keeping for XH7 drier. Because this type of molecular seive has got high humidity absorption . The important point is this for repairing of old refrigerator/freezer, We need the following stations :
- * Reclaim station
- * Recycling "
- * Reprocessing "

to prevent from distribution of CFCs to the environment and also reuse these gases after reprocessing to make the expenses low.

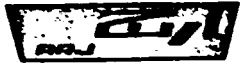

شرکت ارج سازه ARJ CORPORATION

APPENDIX

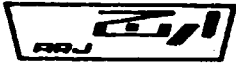

WHY USE R134a

After many years of investigation and testing, HFC 134a has emerged as the industry's choice as an alternative refrigerant for CFC12. R134a has an ozone depletion potential (ODP) factor of zero and a direct global warming potential (GWP) factor of 0.26. It is not flammable and has acceptable toxicity levels.

Unfortunately, R134a is not a "drop-in" replacement for R12. There are significant differences between R12 and R134a which should be considered when handling, processing, applying or retrofitting with R134a.



Refrigerant R 134a

Substitute for R12 in refrigeration engineering Current position

With regard to the ecological compatibility of chlorofluorocarbon refrigerants there is a fundamental difference in the behaviour of the hydrogen-free perhalogenated chlorofluorocarbons and the hydrogen-containing partially halogenated chlorofluorocarbons. The following abbreviations have come into general use in classifying the chlorofluorocarbons into individual subgroups:

CFC : chlorofluorocarbons, perhalogenated (no hydrogen atom in the molecule)

HFC : hydrofluorocarbons fluorocarbons, partially halogenated (contain hydrogen as well as fluorine atoms in the molecule)

The major contribution to the ozone problem comes from the CFCs. Because of the high chemical stability of these products they persist in the atmosphere for a long period of time, and so theoretically the entire amounts released can diffuse into the stratosphere and interfere with the ozone /oxygen balance. Longterm persistence in the atmosphere coupled with accumulation there is also responsible for the high greenhouse potential of these compounds.

Requirements of refrigerant substitutes

By taking a closer look at the requirements profile of refrigerants it can be seen that substitutes for perhalogenated chlorofluorocarbons can come only from this class of compound, but for the reasons discussed above the products must be only partially halogenated ,i.e. they must contain hydrogen. The requirements profile of refrigerants comprises the following points in addition to acceptable ecological properties:

- non-flammability
- good physiological properties
- chemical and thermal stability
- appropriate physical and thermodynamic properties
-



Thermodynamic properties

Comparative refrigerating circuit calculations

Because R134a has similar physical and thermodynamic properties to R12 it will become a substitute of major importance in refrigeration engineering following the withdrawal of some CFC refrigerants.

A comparison of the thermodynamic properties of the two refrigerants is made on the basis of four main refrigerating variables:

* compression ratio	:	P_c/P_o
* volumetric refrigerating effect	:	$q_{o,th}$
* compressor discharge temperature	:	t_E
* coefficient of performance (COP)	:	$3k$

The table below lists these four variables for the following operation conditions:

* evaporating temperature	:	-25°C
* condensing temperature	:	40°C
* suction vapour superheating	:	10°K
* liquid subcooling:	:	5°K

Figs.1-4 show the cycle calculation in graph form.

The compression ratio P_c/P_o is higher in the case of R134a cycles, where as the volumetric refrigerating effect increasingly approaches that of R12 as the evaporating temperature rises. The coefficients of performance are roughly comparable.



ARJ CORPORATION شرکت ارج سازم

The compressor discharge temperature under all operating conditions investigated was generally somewhat lower than that of R12 . Whilst the compressor discharge temperature in R134a cycles is lower, R134a can also be observed to have a volumetric refrigerating effect on average up to 10% lower at low evaporating temperatures. Results obtained by compressor manufacturers have shown that disadvantages in terms of energy consumption are not likely if the compressor is adapted accordingly and the circuit is optimized.



TABLE 2

Physical Properties of HFC-134a

Physical Properties	Units	HFC-134a
Chemical name		Ethane, 1,1,1,2-Tetrafluoro
Chemical Formula	-	CH ₂ FCF ₃
Molecular Weight		102.03
Boiling Point at 1 atm(101.3kPa or 1.013 bar)	°C °F	-26.1 -14.9
Freezing Point	°C °F	-103.0 -153.9
Critical Temperature	°C °F	101.1 213.9
Critical Pressure	kPa lb/in. ² abs	4060 588.9
Critical Volume	m ³ /kg ft ³ /lb	1.94X10 ⁻³ 0.0311
Critical Density	kg/m ³ lb/ft ³	515.3 32.17
Density(Liquid)at 25 °c (77 °F)	kg/m ³ lb/ft ³	1206 75.28
Density(Saturated Vapor) at Boiling Point	kg/m ³ lb/ft ³	5.26 0.328
Heat Capacity(Liquid) at 25 °C (77 °F)	kJ/kg.k or Btu/(lb)(°F)	1.44 0.340
Heat Capacity(Vapor at Constant Pressure) at 25 °C(77 °F) and 1 atm(10.3kPa or 1.013 bar)	kJ/kg.K or Btu(lb)(°F)	0.852 0.204
Vapor Pressure at 25 °c (77 °F)	kPa bar psia	660.1 6.601 96.01
Heat of Vaporization at Boiling point	kJ/kg	217.1



Physical Properties of HFC-134a

Physical Properties	Units	HFC 134a
Thermal Conductivity at 25 °C (77 °F) Liquid	W/m.k Btu/hr.ft.°F	0.0824 0.0478
Vapor at 1 atm (101.3kPa or 1.013 bar)	W/m.k Btu/hr.ft.°F	0.0145 0.00936
Viscosity at 25 °C (77 °F) Liquid	mPa.S(cP)	0.202
at 1 atm (101.3 kPa or 1.013 bar)	mPa.S(cP)	0.012
Solubility of HFC-134a in Water at 25 °C (77 °F) and 1 atm (101.3kPa or 1.013 bar)	wt%	0.10
Solubility of Water in HFC-134a at 25 °C (77 °F)	wt%	0.11
Flammability Limits in Air at 1 atm (101.3kPa or 1.013 bar)	vol%	None
Autoignition Temperature	°C °F	770 1418
Ozone Depletion Potential	-	0
Halocarbon Global Warming Potential (HGWP) (For CFC-11, HGWP=1)	-	0.28
Global Warming Potential (GWP) (100 yr ITH. For Co2 GWP=1)	-	1200
TSCA Inventory Status	-	Included
Toxicity AEL (a) (8-hr and 12-hr TWA)	ppm(v/v)	1,000

(a) AEL (Acceptable Exposure Limit) is an airborne exposure limit established by DuPont scientists for substances to ensure the safe handling and use of that substance.

Note: kPa is absolute pressure.

Reclin 134a

t_0 °C	P_c/P_0	$q_{v,th}$ kJ/m ³	t_r °C	ϵ_k
-25	9.51	748	59.1	2.8
-20	7.63	942	57.7	3.2
-15	6.19	1176	56.5	3.7
-10	5.05	1455	55.4	4.2
-5	4.17	1785	54.5	4.9
0	3.46	2174	53.7	5.8

R 12

t_0 °C	P_c/P_0	$q_{v,th}$ kJ/m ³	t_E °C	ϵ_k
-25	7.78	822	62.6	2.9
-20	6.37	1012	60.8	3.3
-15	5.27	1235	59.3	3.8
-10	4.39	1495	57.9	4.3
-5	3.68	1797	56.6	5.0
0	3.11	2146	55.6	5.8

Fig. 1 Compression ratio

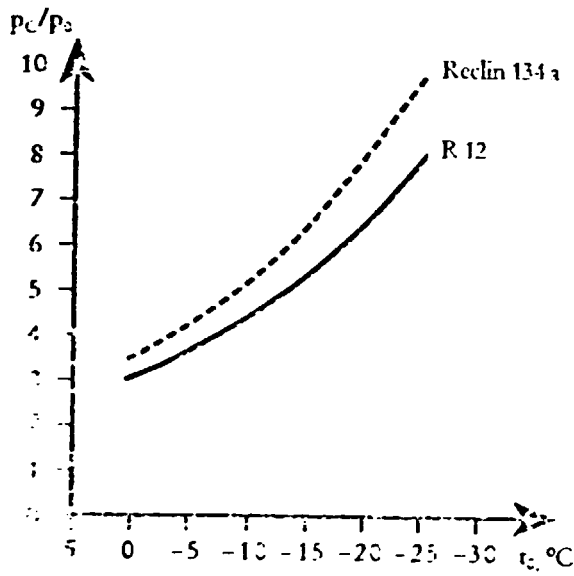

Fig. 3 Compressor discharge temperature

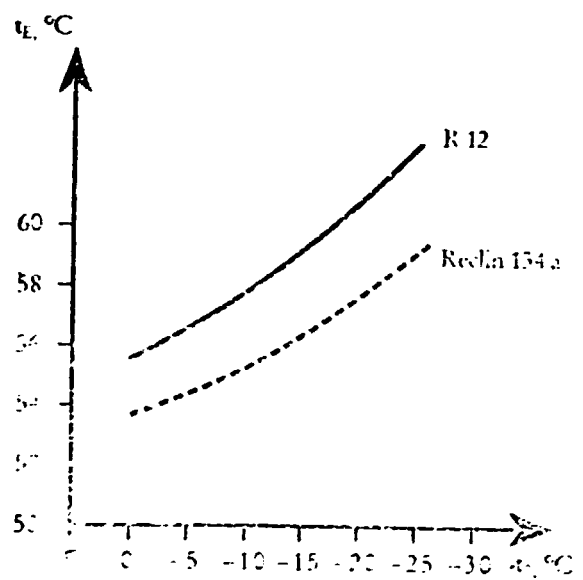

Fig. 2 Volumetric refrigerating effect

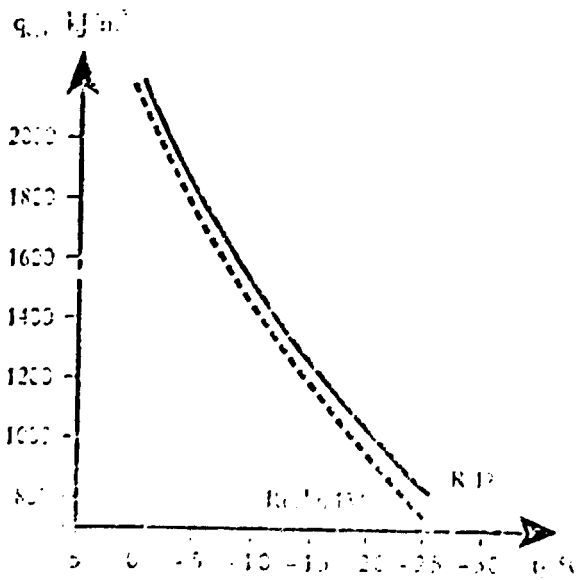

Fig. 4 Coefficient of performance (COP)

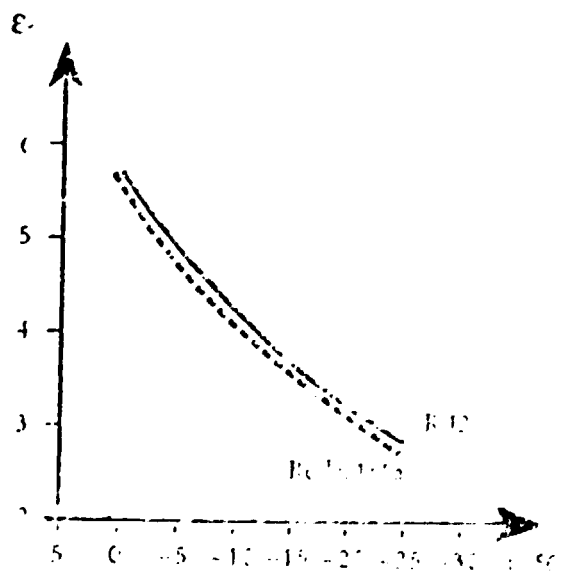

Figure 1. Pressure vs. Temperature

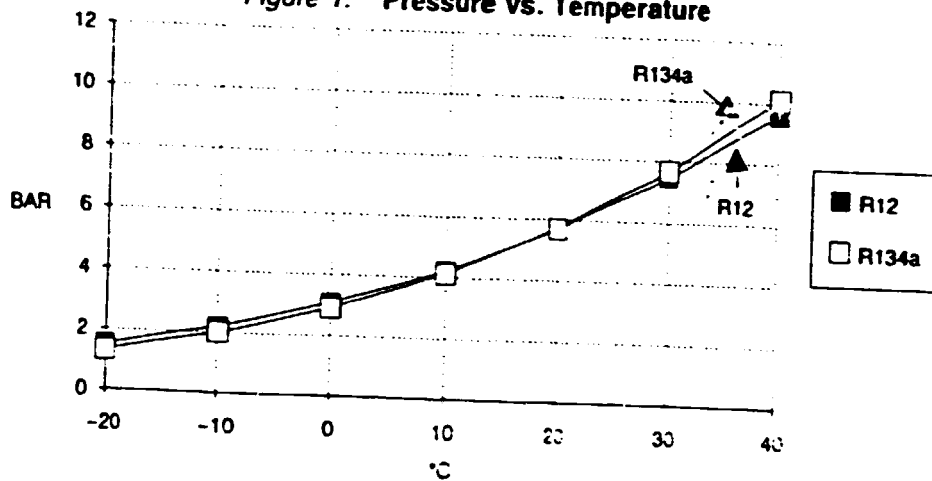
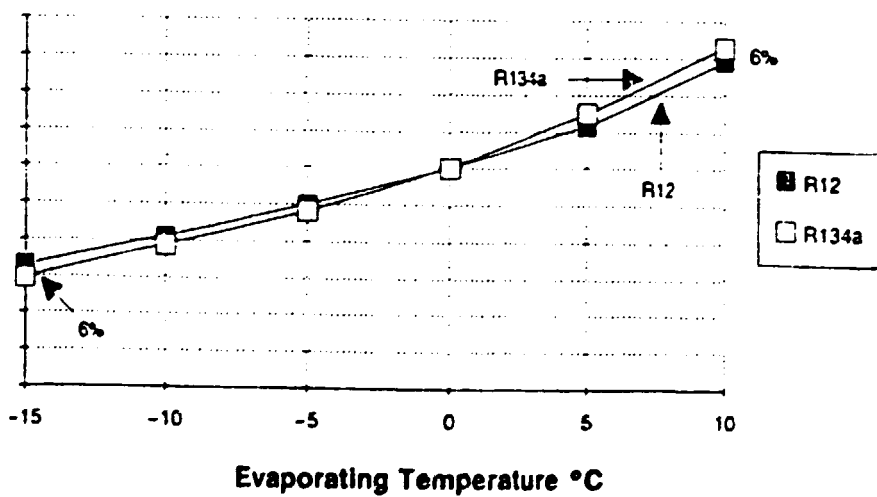

Figure 2. Capacity vs. Evaporating Temperature





REFRIGERANT PROPERTIES

- A. Pressure/temperature plot of R134a vs. R12 is shown in figure
- The cross-over point is approximately at $17,7^{\circ}\text{C}$. Above this temperature, the saturation pressure of R134a is higher than that of R12, below, it is lower.
- B. Capacity curve is shown in figure 2 for relative capacity of R134a vs. R12 for evaporating temperatures from $-17,8^{\circ}\text{C}$ to $+10^{\circ}\text{C}$. This curve is based on $+48,8^{\circ}\text{C}$ condensing temperature. The Cross-over point will move depending on the condensing temperature. The higher the condensing temperature, the higher the cross-over point.
- C. Figure 3 shows the comparison of some properties of R12. The data is taken at the standard refrigerant conditions of -15°C evaporating or $+30^{\circ}\text{C}$ condensing.
- D. For the same amount of subcooling, R134a produces the greater refrigerating effect.
- E. Water Solubility : Liquid R134a, like R22, can absorb much more water than R12, therefore it would be less likely for a low temperature system to exhibit capillary tube blockage due to ice build up.
- F. Extensive investigation and testing have been conducted to determine that R134a is compatible with all materials used in R134a hermetic compressors and condensing units.



Figure 3

DATA		R12	R134a
Chemical Formula		CCL2F2	CF3CH2F
Evaporating Pressure	bar Psig	0,81 11,8	0,63 9,1
Condensing Pressure	bar psig	6,43 93,3	6,69 97
Sat.Vapor Density	at -15 °C (kg/m ³) at 5 °F (Lbs/ft ³)	10,99 0,6859	9,01 0,5128
Sat.Liquid Density	at 30 °C (kg/m ³) at 86 °F (Lbs/ft ³)	1292,8 80,7	1190,2 74,3
Latent Heat of Vapourisation	at - 15 °C (kcal/kg) at 5 °F (BTU/Lb)	1092,5 68,2	1430,5 89,3

NEXT PAGE(S)
left

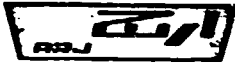

C. Leak Testing

1. Use equipment which is designed for R134a detection or approved for R134a use by its manufacturer.

D. Refrigerant Charging:

1. In general, refrigerant charging equipment such as charging boards, valves and hoses, which are compatible with R22 (considered more aggressive with gaskets and plastics than R12), should be compatible with R134a. This equipment would need to be re-certified for use with R134a. Once designated for R134a use, it should be used specifically for R134a only. Converted R12 equipment should be clean of all residual R12. Pulling a deep vacuum (25 to 50 microns) and repeated flushing with R134a should be sufficient.
2. R134a can be charged in either the liquid or vapour state, if refrigerant charging is done in the liquid state, it should be done into the liquid line. Vapour charging can be done into either the suction or the compressor inlet line.



ARJ CORPORATION شرکت ارج سازان

MODELS SHEMATIC

ARJ - 00001 - 151 - 00001

تعداد: یک نسخه - تهران - آدرس: تهران - خیابان ولیعصر - پلاک ۱۴۱ - طبقه اول - واحد ۱۴۱ - تلفن: ۹۰۱۴۳۸

Model: 6246 a

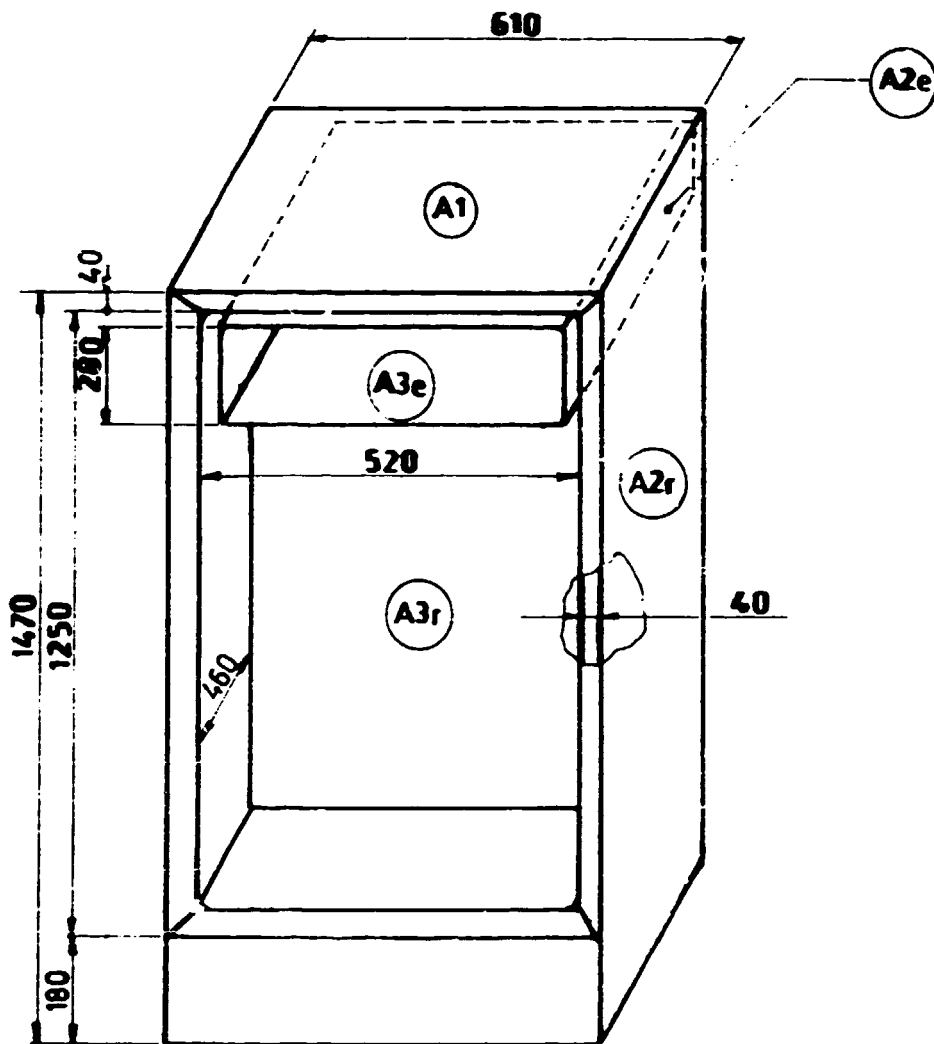

A (outside area)

A' (inside area)

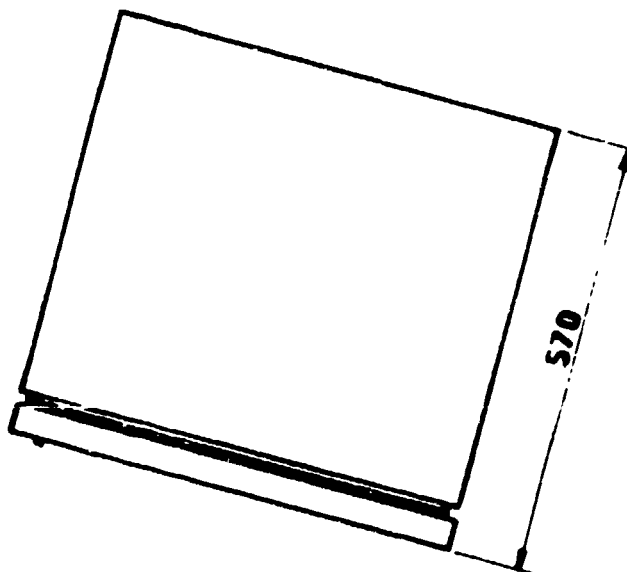

Model: 6247a

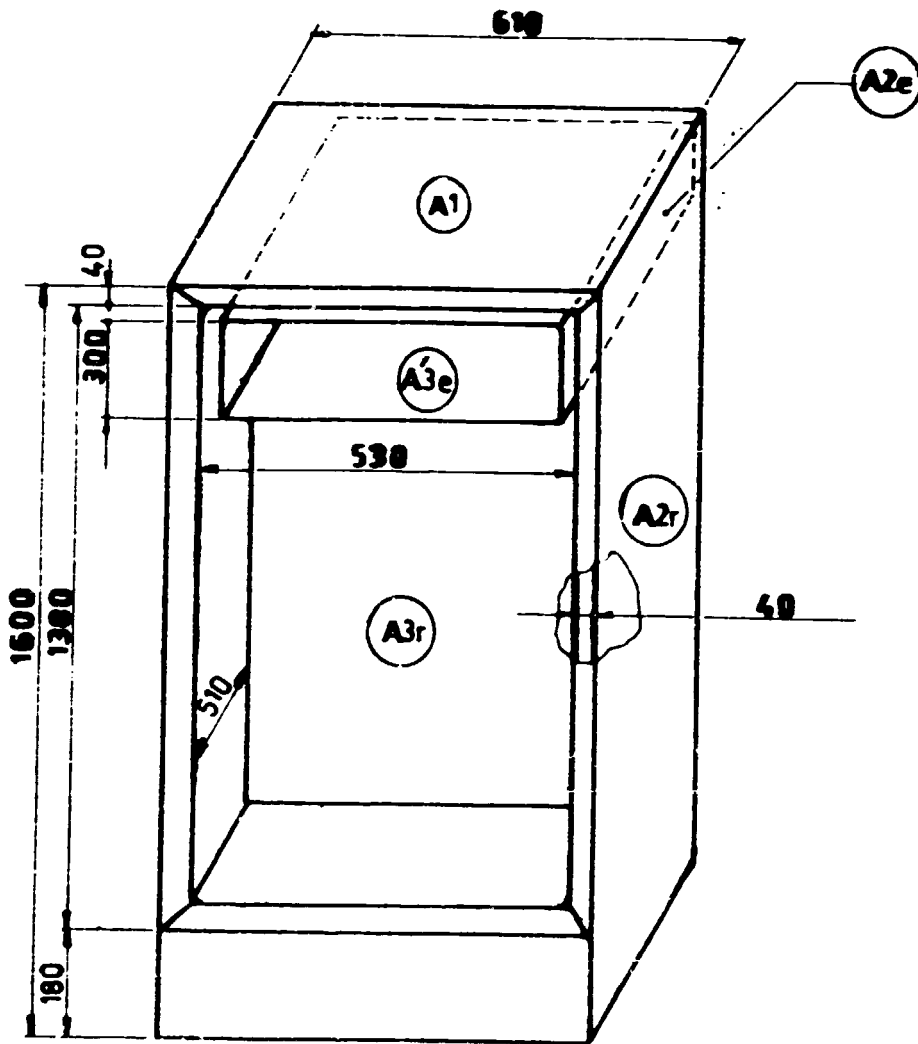

A (outside area)

A' (inside area)

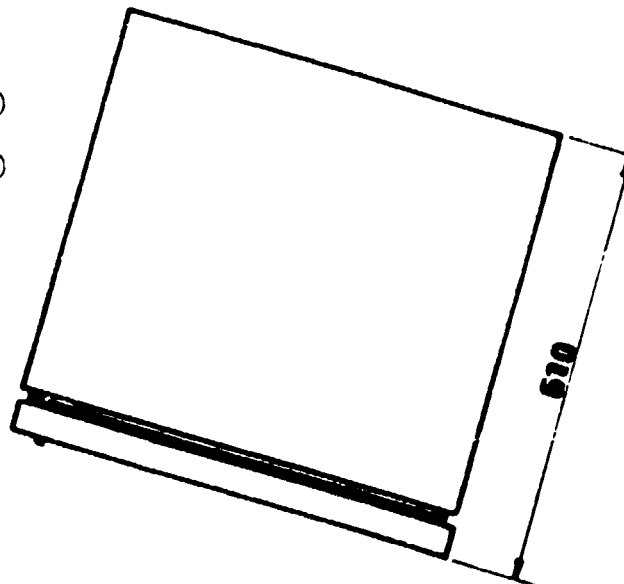

Model: 6243a

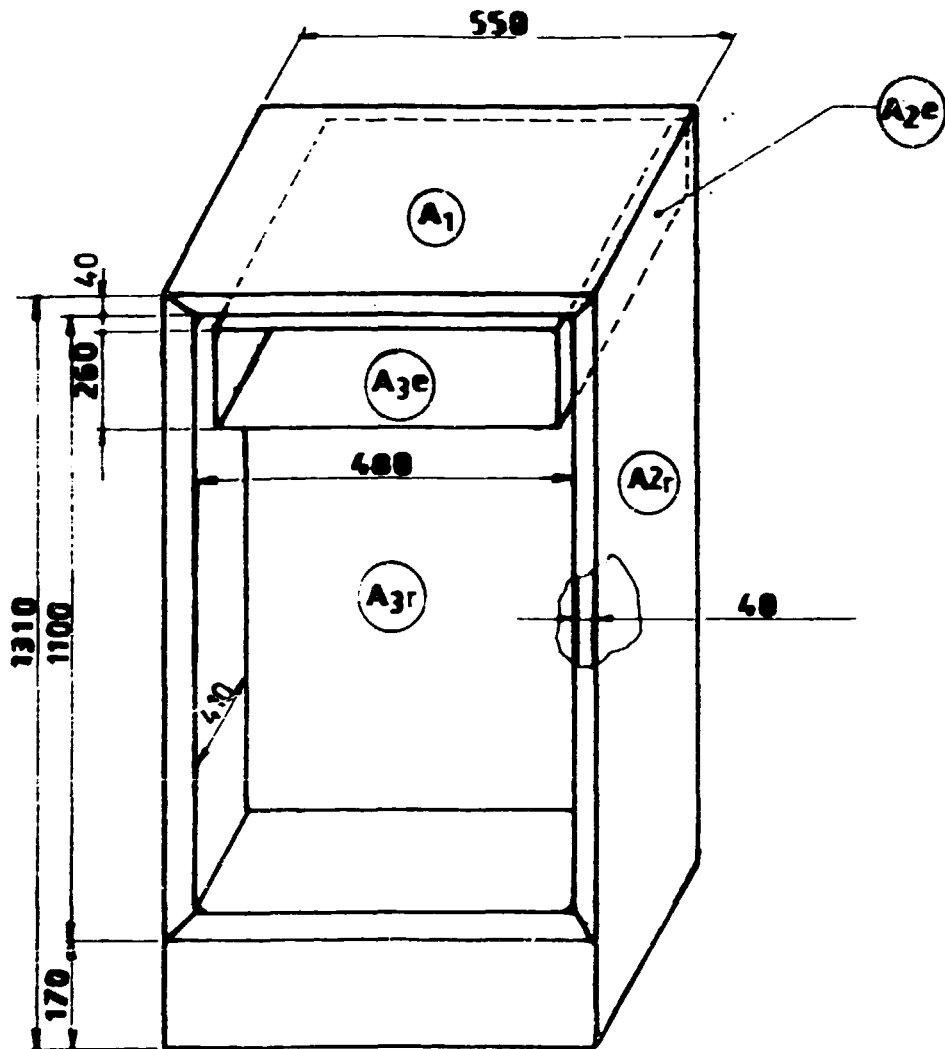

A (outside area)

A' (inside area)

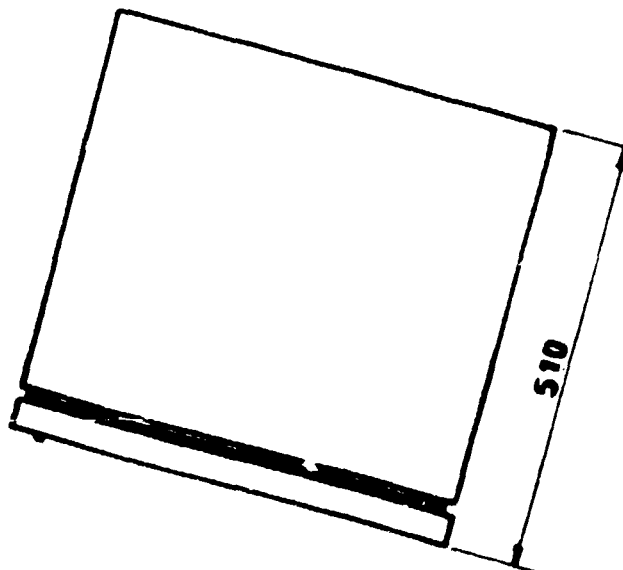

Model: 6202 a
// : 6201

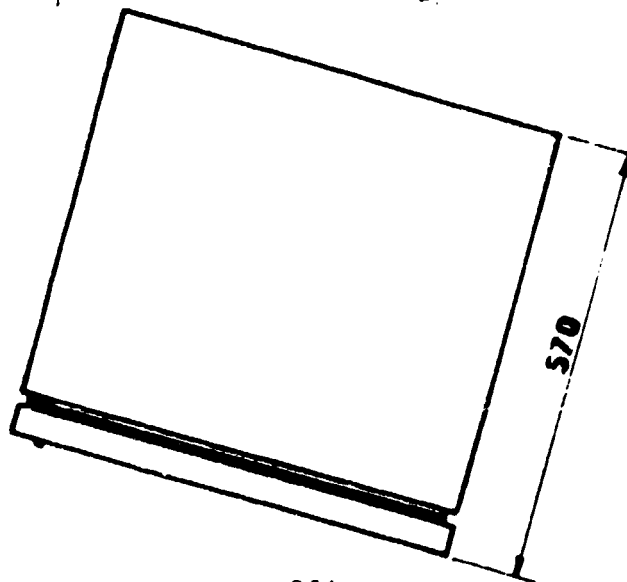
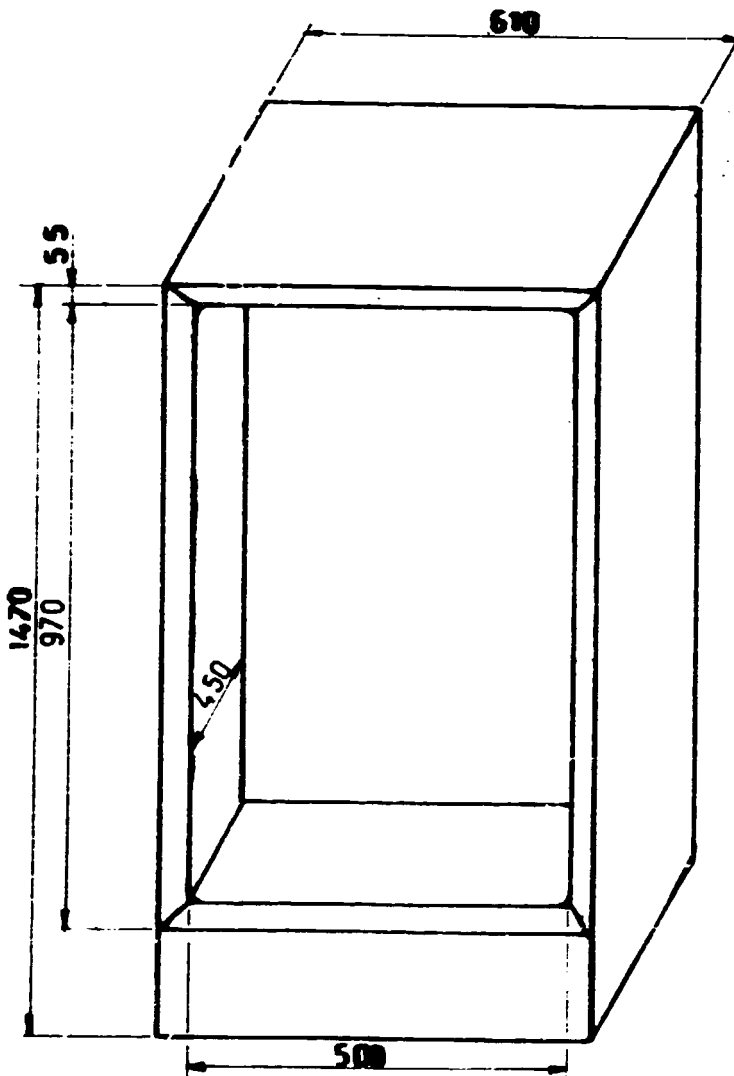

Model 6249 a

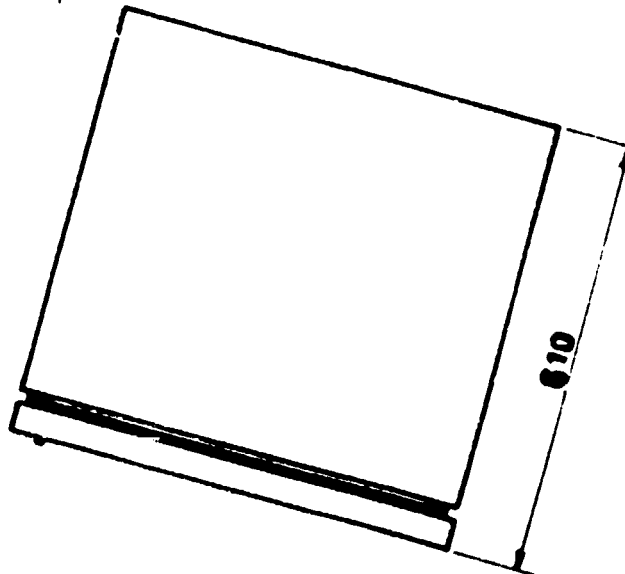
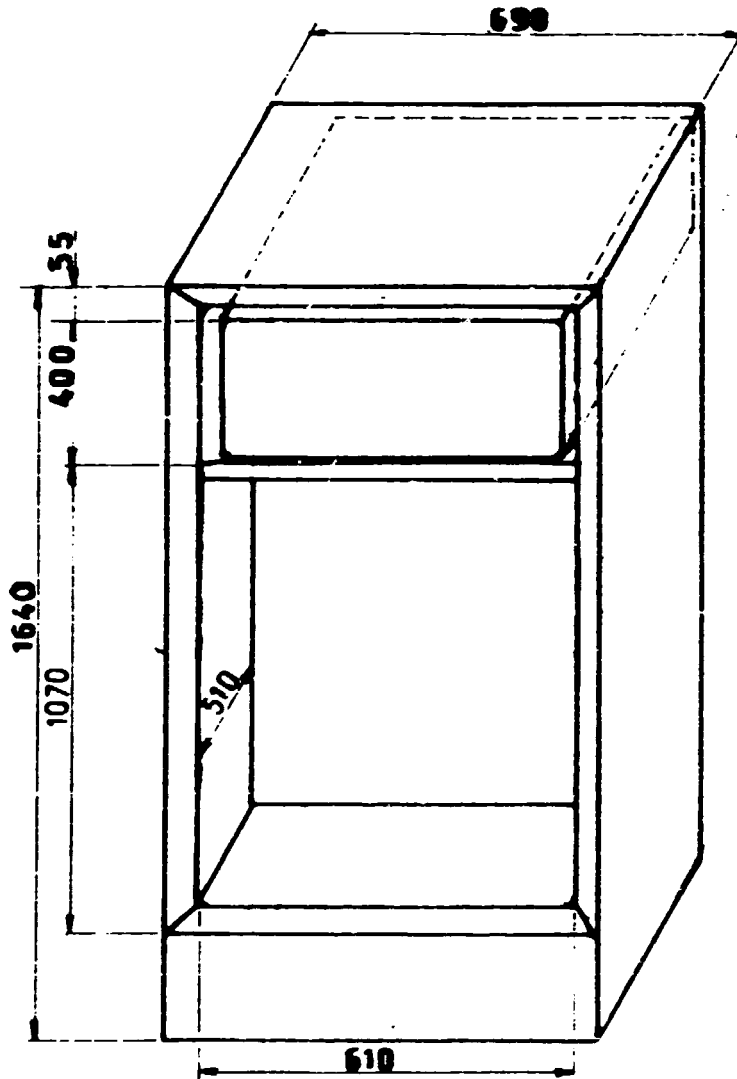

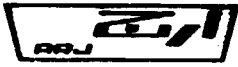

شرکت ارج سنوا ARJ CORPORATION

R134a VAPOUR TABLES

Reclin 134a

Vapour table for the wet vapour range

Temperature t °C	Pressure p bar	Specific volume		Density		Enthalpy		Heat of vaporization r kJ/kg	Entropy	
		of liquid v l/kg	of vapour v' l/kg	of liquid ρ kg/l	of vapour ρ' kg/m ³	of liquid h kJ/kg	of vapour h' kJ/kg		of liquid s kJ/kg·K	of vapour s' kJ/kg·K
-60	0.163	0.679	1052.08	1.472	0.950	126.54	359.84	233.30	0.6984	1.7930
-59	0.174	0.680	991.41	1.470	1.009	127.64	360.49	232.85	0.7035	1.7909
-58	0.185	0.682	934.82	1.467	1.070	128.74	361.13	232.39	0.7087	1.7888
-57	0.197	0.683	882.01	1.464	1.134	129.85	361.78	231.93	0.7138	1.7868
-56	0.209	0.684	832.70	1.461	1.201	130.96	362.43	231.47	0.7189	1.7849
-55	0.223	0.686	786.61	1.459	1.271	132.08	363.08	231.00	0.7241	1.7830
-54	0.236	0.687	743.51	1.456	1.345	133.20	363.72	230.53	0.7292	1.7811
-53	0.251	0.688	703.19	1.453	1.422	134.32	364.37	230.05	0.7345	1.7793
-52	0.266	0.689	665.43	1.451	1.503	135.45	365.02	229.57	0.7394	1.7775
-51	0.282	0.691	630.05	1.448	1.587	136.58	365.67	229.09	0.7445	1.7757
-50	0.299	0.692	596.88	1.445	1.675	137.72	366.32	228.60	0.7496	1.7740
-49	0.316	0.693	565.77	1.442	1.767	138.86	366.96	228.10	0.7547	1.7723
-48	0.335	0.695	536.57	1.440	1.864	140.01	367.61	227.60	0.7598	1.7707
-47	0.354	0.696	509.15	1.437	1.964	141.16	368.26	227.10	0.7649	1.7691
-46	0.374	0.697	483.37	1.434	2.069	142.32	368.91	226.59	0.7702	1.7675
-45	0.396	0.699	459.14	1.431	2.178	143.48	369.55	226.08	0.7751	1.7660
-44	0.418	0.700	436.34	1.428	2.292	144.64	370.20	225.56	0.7802	1.7645
-43	0.441	0.701	414.88	1.426	2.410	145.81	370.84	225.03	0.7853	1.7630
-42	0.463	0.703	394.67	1.423	2.534	146.98	371.49	224.51	0.7903	1.7616
-41	0.490	0.704	375.62	1.420	2.662	148.16	372.13	223.97	0.7954	1.7602
-40	0.516	0.706	357.66	1.417	2.796	149.34	372.78	223.44	0.8005	1.7588
-39	0.544	0.707	340.72	1.414	2.935	150.53	373.42	222.89	0.8056	1.7575
-38	0.572	0.708	324.73	1.412	3.079	151.72	374.07	222.35	0.8106	1.7562
-37	0.602	0.710	309.63	1.409	3.230	152.91	374.71	221.79	0.8157	1.7549
-36	0.633	0.711	295.36	1.406	3.386	154.11	375.35	221.24	0.8208	1.7536
-35	0.666	0.713	281.87	1.403	3.548	155.32	375.99	220.67	0.8258	1.7524
-34	0.699	0.714	269.12	1.400	3.716	156.53	376.63	220.10	0.8309	1.7512
-33	0.734	0.716	257.05	1.397	3.890	157.74	377.27	219.53	0.8359	1.7501
-32	0.770	0.717	245.62	1.394	4.071	158.96	377.91	218.95	0.8412	1.7490
-31	0.808	0.719	234.80	1.391	4.259	160.18	378.54	218.37	0.8462	1.7479
-30	0.848	0.720	224.55	1.388	4.453	161.40	379.18	217.78	0.8510	1.7467
-29	0.888	0.722	214.83	1.385	4.655	162.63	379.82	217.18	0.8561	1.7456
-28	0.931	0.723	205.61	1.383	4.864	163.87	380.45	216.58	0.8611	1.7446
-27	0.975	0.725	196.86	1.380	5.080	165.10	381.08	215.98	0.8661	1.7436
-26	1.020	0.726	188.56	1.377	5.303	166.35	381.71	215.37	0.8712	1.7426
-25	1.067	0.728	180.67	1.374	5.535	167.59	382.34	214.75	0.8762	1.7416
-24	1.116	0.730	173.18	1.371	5.774	168.84	382.97	214.13	0.8812	1.7406
-23	1.167	0.731	166.06	1.368	6.022	170.10	383.60	213.50	0.8862	1.7397
-22	1.220	0.733	159.28	1.365	6.278	171.36	384.23	212.87	0.8912	1.7388
-21	1.274	0.734	152.84	1.362	6.543	172.62	384.85	212.23	0.8962	1.7379
-20	1.330	0.736	146.71	1.359	6.816	173.89	385.48	211.59	0.9012	1.7370
-19	1.389	0.738	140.87	1.356	7.099	175.16	386.10	210.94	0.9062	1.7362
-18	1.449	0.739	135.31	1.353	7.390	176.43	386.72	210.29	0.9112	1.7354
-17	1.511	0.741	130.01	1.349	7.692	177.71	387.34	209.63	0.9162	1.7346
-16	1.575	0.743	124.96	1.346	8.011	178.99	387.95	208.97	0.9211	1.7338

Vapour table for the wet vapour range

Temperature t °C	Pressure p bar	Specific volume		Density		Enthalpy		Heat of vaporisation r kJ/kg	Entropy	
		of liquid v l/kg	of vapour v l/kg	of liquid ρ kg/l	of vapour ρ m ⁻³	of liquid h' kJ/kg	of vapour h'' kJ/kg		of liquid s' kJ/kg K	of vapour s'' kJ/kg K
-15	1.642	0.744	120.15	1.345	8.323	180.28	388.57	208.29	0.9261	1.7380
-14	1.711	0.746	115.55	1.340	8.654	181.57	389.18	207.62	0.9311	1.7322
-13	1.781	0.748	111.17	1.337	8.995	182.86	389.79	206.93	0.9360	1.7315
-12	1.855	0.750	106.99	1.334	9.347	184.16	390.40	206.25	0.9410	1.7308
-11	1.930	0.751	102.99	1.331	9.710	185.46	391.01	205.55	0.9459	1.7301
-10	2.008	0.753	99.17	1.328	10.084	186.76	391.62	204.85	0.9509	1.7294
-9	2.088	0.755	95.52	1.325	10.469	188.07	392.22	204.15	0.9558	1.7287
-8	2.171	0.757	92.03	1.321	10.866	189.38	392.82	203.44	0.9608	1.7280
-7	2.256	0.759	88.70	1.318	11.274	190.70	393.42	202.73	0.9657	1.7274
-6	2.344	0.760	85.51	1.315	11.695	192.02	394.02	202.00	0.9706	1.7268
-5	2.435	0.762	82.45	1.312	12.128	193.34	394.62	201.28	0.9755	1.7261
-4	2.528	0.764	79.53	1.309	12.574	194.66	395.21	200.55	0.9804	1.7255
-3	2.624	0.766	76.73	1.305	13.033	195.99	395.80	199.81	0.9853	1.7250
-2	2.723	0.768	74.04	1.302	13.505	197.33	396.39	199.06	0.9902	1.7244
-1	2.825	0.770	71.47	1.299	13.991	198.66	396.98	198.31	0.9951	1.7238
0	2.929	0.772	69.01	1.295	14.491	200.00	397.56	197.56	1.0000	1.7233
1	3.037	0.774	66.65	1.292	15.005	201.34	398.14	196.80	1.0049	1.7227
2	3.147	0.776	64.38	1.289	15.533	202.69	398.72	196.03	1.0097	1.7222
3	3.261	0.778	62.21	1.285	16.076	204.04	399.30	195.26	1.0146	1.7217
4	3.377	0.780	60.12	1.282	16.634	205.39	399.87	194.48	1.0195	1.7212
5	3.497	0.782	58.11	1.279	17.207	206.74	400.44	193.70	1.0243	1.7207
6	3.620	0.784	56.19	1.275	17.797	208.10	401.01	192.91	1.0291	1.7202
7	3.747	0.786	54.34	1.272	18.402	209.46	401.58	192.11	1.0340	1.7197
8	3.876	0.788	52.56	1.269	19.024	210.83	402.14	191.31	1.0388	1.7193
9	4.010	0.790	50.86	1.265	19.663	212.20	402.70	190.51	1.0436	1.7188
10	4.146	0.793	49.22	1.262	20.319	213.57	403.26	189.69	1.0484	1.7184
11	4.286	0.795	47.64	1.258	20.992	214.94	403.81	188.87	1.0532	1.7179
12	4.430	0.797	46.12	1.255	21.684	216.32	404.36	188.05	1.0580	1.7175
13	4.577	0.799	44.66	1.251	22.394	217.70	404.91	187.22	1.0628	1.7171
14	4.728	0.802	43.25	1.248	23.122	219.08	405.46	186.38	1.0676	1.7167
15	4.883	0.804	41.89	1.244	23.870	220.46	406.00	185.54	1.0724	1.7163
16	5.042	0.806	40.59	1.241	24.637	221.85	406.54	184.69	1.0771	1.7159
17	5.204	0.808	39.33	1.237	25.425	223.24	407.08	183.83	1.0819	1.7155
18	5.371	0.811	38.12	1.233	26.233	224.64	407.61	182.97	1.0867	1.7151
19	5.541	0.813	36.95	1.230	27.061	226.04	408.14	182.10	1.0914	1.7147
20	5.716	0.816	35.83	1.226	27.912	227.44	408.66	181.23	1.0961	1.7143
21	5.894	0.818	34.74	1.222	28.784	228.84	409.19	180.35	1.1009	1.7140
22	6.077	0.821	33.69	1.219	29.678	230.25	409.70	179.46	1.1056	1.7136
23	6.264	0.823	32.68	1.215	30.596	231.65	410.22	178.56	1.1103	1.7132
24	6.456	0.826	31.71	1.211	31.536	233.07	410.73	177.66	1.1150	1.7129
25	6.651	0.828	30.77	1.207	32.501	234.48	411.24	176.76	1.1197	1.7125
26	6.852	0.831	29.86	1.204	33.490	235.90	411.74	175.84	1.1244	1.7122
27	7.056	0.833	28.98	1.200	34.505	237.32	412.24	174.92	1.1291	1.7119
28	7.266	0.836	28.13	1.196	35.545	238.75	412.74	173.99	1.1338	1.7115
29	7.480	0.839	27.31	1.192	36.611	240.17	413.24	173.05	1.1384	1.7112

Reclin 134a

Vapour table for the wet vapour range

Temperature t °C	Pressure bar	Specific volume		Density		Enthalpy		Heat of vaporization r kJ/kg	Entropy	
		of liquid v l/kg	of vapour v l/kg	of liquid ρ kg/l	of vapour ρ kg/m ³	of liquid h kJ/kg	of vapour h kJ/kg		of liquid s kJ/kg K	of vapour s kJ/kg K
30	7.698	0.842	26.52	1.188	37.704	241.61	413.71	172.11	1.1431	1.7108
31	7.922	0.844	25.76	1.184	38.825	243.04	414.20	171.16	1.1478	1.7105
32	8.150	0.847	25.02	1.180	39.974	244.48	414.68	170.20	1.1524	1.7102
33	8.384	0.850	24.30	1.176	41.152	245.92	415.15	169.23	1.1571	1.7098
34	8.622	0.853	23.61	1.172	42.360	247.36	415.62	168.26	1.1617	1.7095
35	8.865	0.856	22.94	1.168	43.598	248.81	416.08	167.27	1.1664	1.7092
36	9.113	0.859	22.29	1.164	44.867	250.26	416.54	166.28	1.1710	1.7089
37	9.367	0.862	21.66	1.160	46.169	251.72	417.00	165.28	1.1756	1.7085
38	9.626	0.865	21.05	1.156	47.503	253.18	417.45	164.27	1.1802	1.7082
39	9.890	0.868	20.46	1.152	48.871	254.64	417.89	163.25	1.1849	1.7079
40	10.160	0.871	19.89	1.147	50.273	256.11	418.33	162.23	1.1895	1.7075
41	10.435	0.875	19.34	1.143	51.711	257.58	418.77	161.19	1.1941	1.7072
42	10.716	0.878	18.80	1.139	53.186	259.05	419.20	160.14	1.1987	1.7069
43	11.002	0.881	18.28	1.135	54.698	260.53	419.62	159.09	1.2033	1.7065
44	11.294	0.885	17.78	1.130	56.249	262.02	420.04	158.02	1.2079	1.7062
45	11.592	0.888	17.29	1.126	57.839	263.50	420.45	156.94	1.2125	1.7058
46	11.896	0.892	16.82	1.121	59.471	265.00	420.85	155.86	1.2171	1.7055
47	12.205	0.895	16.35	1.117	61.144	266.50	421.25	154.76	1.2217	1.7051
48	12.521	0.899	15.91	1.112	62.861	268.00	421.64	153.65	1.2263	1.7047
49	12.843	0.903	15.47	1.108	64.622	269.51	422.03	152.52	1.2309	1.7044
50	13.171	0.907	15.05	1.103	66.430	271.02	422.41	151.39	1.2355	1.7040
51	13.505	0.910	14.64	1.098	68.285	272.54	422.78	150.24	1.2401	1.7036
52	13.846	0.914	14.25	1.094	70.189	274.07	423.15	149.08	1.2447	1.7032
53	14.193	0.918	13.86	1.089	72.144	275.60	423.50	147.90	1.2493	1.7028
54	14.547	0.922	13.49	1.084	74.151	277.14	423.85	146.71	1.2539	1.7024
55	14.907	0.927	13.12	1.079	76.212	278.69	424.19	145.51	1.2586	1.7020
56	15.274	0.931	12.77	1.074	78.329	280.24	424.52	144.29	1.2632	1.7015
57	15.648	0.935	12.42	1.069	80.505	281.80	424.85	143.05	1.2678	1.7011
58	16.028	0.940	12.09	1.064	82.741	283.37	425.16	141.80	1.2724	1.7006
59	16.414	0.944	11.76	1.059	85.039	284.94	425.47	140.53	1.2771	1.7002
60	16.811	0.949	11.44	1.054	87.401	286.53	425.76	139.24	1.2817	1.6997
61	17.213	0.954	11.13	1.049	89.831	288.12	426.05	137.93	1.2864	1.6992
62	17.622	0.959	10.83	1.043	92.332	289.72	426.33	136.61	1.2911	1.6987
63	18.038	0.964	10.54	1.038	94.905	291.34	426.59	135.28	1.2958	1.6981
64	18.463	0.969	10.25	1.032	97.554	292.96	426.84	133.93	1.3005	1.6976
65	18.894	0.974	9.97	1.027	100.282	294.59	427.09	132.49	1.3052	1.6970
66	19.333	0.980	9.70	1.021	103.092	296.24	427.31	131.07	1.3099	1.6964
67	19.781	0.985	9.43	1.015	105.990	297.90	427.53	129.63	1.3147	1.6958
68	20.236	0.991	9.18	1.009	108.977	299.57	427.73	128.17	1.3194	1.6951
69	20.699	0.997	8.92	1.003	112.060	301.25	427.92	126.67	1.3242	1.6944
70	21.170	1.003	8.68	0.997	115.242	302.95	428.10	125.15	1.3290	1.6937
71	21.649	1.009	8.44	0.991	118.529	304.66	428.25	123.59	1.3338	1.6930
72	22.137	1.016	8.20	0.985	121.924	306.39	428.40	122.00	1.3388	1.6922
73	22.633	1.022	7.97	0.978	125.439	308.14	428.52	120.38	1.3437	1.6914
74	23.137	1.029	7.75	0.972	129.075	309.91	428.63	118.72	1.3486	1.6906

Refin 10 la

Vapour table for the wet vapour range

Temperature t °C	Pressure p bar	Specific volume		Density		Enthalpy		Heat of vaporisation r kJ/kg	Entropy	
		of liquid v l/kg	of vapour v l/kg	of liquid ρ kg/l	of vapour ρ kg/m ³	of liquid h kJ/kg	of vapour h kJ/kg		of liquid s kJ/kg·K	of vapour s kJ/kg·K
75	23.651	1.036	7.53	0.965	132.840	311.68	428.71	117.03	1.3536	1.6897
76	24.173	1.044	7.31	0.958	136.742	313.49	428.78	115.29	1.3586	1.6888
77	24.704	1.051	7.10	0.951	140.795	315.31	428.82	113.51	1.3637	1.6878
78	25.245	1.059	6.90	0.944	145.001	317.16	428.84	111.68	1.3688	1.6868
79	25.794	1.068	6.69	0.937	149.375	319.03	428.84	109.80	1.3739	1.6857
80	26.353	1.076	6.50	0.929	153.927	320.93	428.81	107.87	1.3791	1.6846
81	26.921	1.086	6.30	0.921	158.672	322.86	428.75	105.88	1.3844	1.6834
82	27.499	1.095	6.11	0.913	163.625	324.82	428.66	103.83	1.3898	1.6821
83	28.087	1.105	5.92	0.905	168.803	326.81	428.53	101.72	1.3952	1.6808
84	28.685	1.116	5.74	0.896	174.225	328.84	428.37	99.53	1.4007	1.6794
85	29.292	1.127	5.56	0.887	179.915	330.91	428.17	97.26	1.4063	1.6778
86	29.910	1.139	5.38	0.878	185.900	333.03	427.93	94.90	1.4120	1.6762
87	30.539	1.151	5.20	0.869	192.209	335.19	427.63	92.44	1.4178	1.6745
88	31.177	1.165	5.03	0.859	198.881	337.40	427.29	89.88	1.4237	1.6726
89	31.827	1.179	4.86	0.848	205.959	339.68	426.88	87.20	1.4298	1.6706
90	32.487	1.194	4.68	0.837	213.499	342.02	426.40	84.38	1.4361	1.6684
91	33.159	1.211	4.51	0.826	221.566	344.44	425.85	81.41	1.4425	1.6661
92	33.841	1.230	4.34	0.813	230.246	346.95	425.21	78.26	1.4492	1.6635
93	34.535	1.250	4.17	0.800	239.649	349.57	424.46	74.89	1.4561	1.6606
94	35.241	1.272	4.00	0.786	249.924	352.31	423.59	71.28	1.4633	1.6574
95	35.958	1.298	3.83	0.771	261.274	355.20	422.55	67.36	1.4709	1.6539
96	36.688	1.327	3.65	0.753	273.999	358.28	421.32	63.04	1.4790	1.6498
97	37.429	1.362	3.47	0.734	288.566	361.62	419.82	58.20	1.4878	1.6450
98	38.183	1.405	3.27	0.712	305.774	365.32	417.95	52.62	1.4975	1.6393
99	38.949	1.461	3.06	0.685	327.219	369.60	415.46	45.87	1.5087	1.6319
100	39.728	1.544	2.80	0.648	357.099	374.97	411.79	36.38	1.5228	1.6215
101	40.520	1.742	2.37	0.574	422.387	384.56	403.26	18.70	1.5491	1.5981
101.15	40.640	1.970	1.97	0.508	507.500	392.27	392.27	0.00	1.5687	1.5687



شرکت ارج اسفند
ARJ CORPORATION

TUBING CONDENSOR TABLES

10000 - 1337 - 10000 - 1337

تولید کننده: شرکت ارج اسفند، تهران، ایران. شماره تماس: 904015-19

BOX 8667, TEHRAN, IRAN. CABLE: TELEX 212576 ARJ, TEHRAN, FAX: 903438 TEL: 904015-19

CONDENSATORI IN TUBO \varnothing e 4.75 mm.
3.16" OD TUBING CONDENSERS

N. = NUMERO TUBI
NUMBER OF LEGS

V (cm³) = VOLUME INTERNO
INTERNAL VOLUME

KS (Kcal/h °C) = RESA TERMICA
RATING

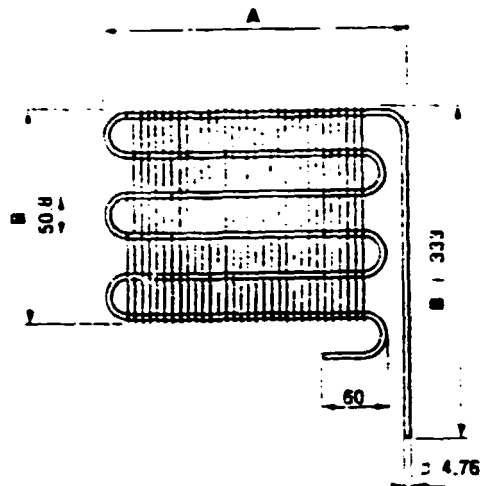

Serie 51-51-476 Series

	MODELLO - MODEL									
	51-51-476 06	51-51-476 08	51-51-476 10	51-51-476 12	51-51-476 14	51-51-476 16	51-51-476 18	51-51-476 20	51-51-476 22	51-51-476 24
A	572.50	572.50	572.50	572.50	572.50	572.50	572.50	572.50	572.50	572.50
B	267	369	471	572	674	775	876	979	1079	1179
N.	6	8	10	12	14	16	18	20	22	24
V	36.56	47.76	58.94	70.12	81.30	92.49	103.67	114.85	125.48	137.22
KS	3.25	4.20	5.10	6.05	7.00	7.90	8.85	9.80	10.75	11.70

Serie 55-51-476 Series

	MODELLO - MODEL									
	55-51-476 06	55-51-476 08	55-51-476 10	55-51-476 12	55-51-476 14	55-51-476 16	55-51-476 18	55-51-476 20	55-51-476 22	55-51-476 24
A	610	610	610	610	610	610	610	610	610	610
B	267	369	471	572	674	775	876	979	1079	1179
N.	6	8	10	12	14	16	18	20	22	24
V	38.54	50.38	62.22	74.06	85.90	97.74	109.58	121.42	133.26	145.10
KS	3.45	4.45	5.45	6.45	7.45	8.50	9.50	10.50	11.55	12.55

I modelli di condensatori su fondo giallo sono quelli di normale produzione, gli altri possono essere forniti su richiesta dei clienti.

Yellow underlined condensers are of standard production. The others may be supplied on Customers' request.

CONDENSATORI IN TUBO \varnothing e 4.76 mm.
3/16" OD TUBING CONDENSERS

N. = NUMERO TUBI
NUMBER OF LEGS

V (cm³) = VOLUME INTERNO
INTERNAL VOLUME

KS (Kcal/h °C) = RESA TERMICA
RATING

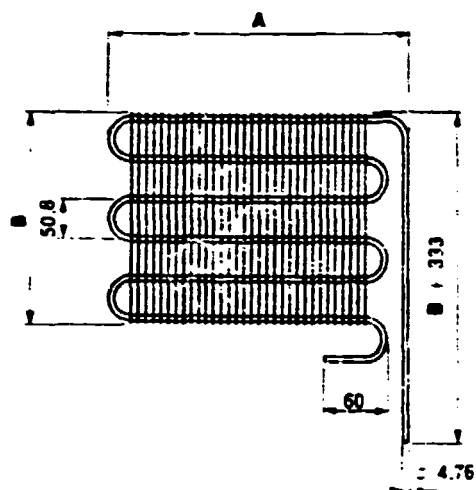

Serie 40-51-476 Series

	MODELLO - MODEL									
	40-51-476 06	40-51-476 08	40-51-476 10	40-51-476 12	40-51-476 14	40-51-476 16	40-51-476 18	40-51-476 20	40-51-476 22	40-51-476 24
A	466	466	466	466	466	466	466	466	466	466
B	267	369	471	572	674	775	876	979	1079	1179
N.	6	8	10	12	14	16	18	20	22	24
V	30.91	40.20	49.49	58.78	68.07	77.36	86.66	95.95	105.24	114.54
KS	2.60	3.40	4.15	4.95	5.70	6.50	7.25	8.00	8.80	9.55

Serie 45-51-476 Series

	MODELLO - MODEL									
	45-51-476 06	45-51-476 08	45-51-476 10	45-51-476 12	45-51-476 14	45-51-476 16	45-51-476 18	45-51-476 20	45-51-476 22	45-51-476 24
A	515.50	515.50	515.50	515.50	515.50	515.50	515.50	515.50	515.50	515.50
B	267	369	471	572	674	775	876	979	1079	1179
N.	6	8	10	12	14	16	18	20	22	24
V	33.51	43.67	53.82	63.98	74.14	84.30	94.46	104.62	114.78	124.94
KS	2.90	3.75	4.60	5.45	6.25	7.10	7.95	8.80	9.65	10.50

I modelli di condensatori su fondo giallo sono quelli di normale produzione, gli altri possono essere forniti su richiesta dei clienti

Yellow underlined condensers are of standard production. The others may be supplied on Customers' request.

CONDENSATORI IN TURO ϕ e 6.35 mm.
1,4" O.D TUBING CONDENSERS

N. = NUMERO TUBI
NUMBER OF LEGS

V (cm³) = VOLUME INTERNO
INTERNAL VOLUME

KS (Kcal/h°C) = RESA TERMICA
RATING

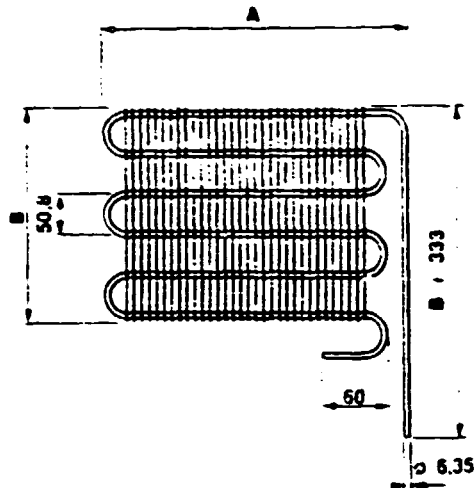

Serie 51-51-635 Series

	MODELLO - MODEL									
	51-51-635 06	51-51-635 08	51-51-635 10	51-51-635 12	51-51-635 14	51-51-635 16	51-51-635 18	51-51-635 20	51-51-635 22	51-51-635 24
A	572	572	572	572	572	572	572	572	572	572
B	267	369	471	572	674	775	876	979	1079	1179
N.	6	8	10	12	14	16	18	20	22	24
V	79.46	103.77	128.07	152.38	176.67	200.97	225.26	249.57	273.87	298.18
KS	3.35	4.30	5.25	6.20	7.20	8.15	9.10	10.05	11.00	12.00

Serie 55-51-635 Series

	MODELLO - MODEL									
	55-51-635 06	55-51-635 08	55-51-635 10	55-51-635 12	55-51-635 14	55-51-635 16	55-51-635 18	55-51-635 20	55-51-635 22	55-51-635 24
A	512	512	612	612	612	612	612	612	612	512
B	267	369	471	572	674	775	876	979	1079	1179
N.	6	8	10	12	14	16	18	20	22	24
V	83.98	109.79	135.59	161.40	187.22	213.01	238.83	264.64	290.43	316.25
KS	3.55	4.60	5.60	6.60	7.65	8.70	9.70	10.75	11.75	12.80

I modelli di condensatori su fondo giallo sono quelli di normale produzione, gli altri possono essere forniti su richiesta dei clienti.

Yellow underlined condensers are of standard production. The others may be supplied on Customers' request.

CONDENSATORI IN TUBO \varnothing e 6.35 mm.
1/4" OD TUBING CONDENSERS

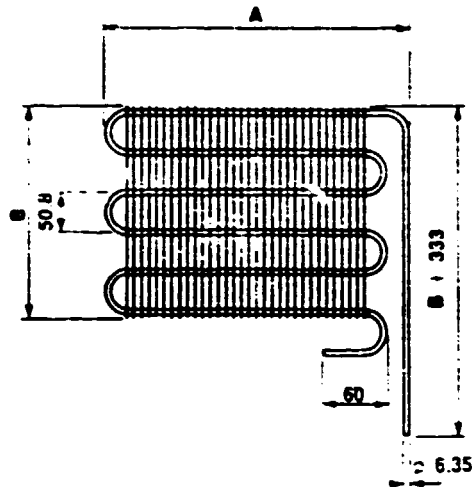

N. = NUMERO TUBI
NUMBER OF LEGS

V (cm³) = VOLUME INTERNO
INTERNAL VOLUME

KS (Kcal/h°C) = RESA TERMICA
RATING

Serie 40-51-635 Series

	MODELLO - MODEL									
	40-51-635 06	40-51-635 08	40-51-635 10	40-51-635 12	40-51-635 14	40-51-635 16	40-51-635 18	40-51-635 20	40-51-635 22	40-51-635 24
A	468	468	468	468	468	468	468	468	468	468
B	267	369	471	572	674	775	876	979	1079	1179
N.	6	8	10	12	14	16	18	20	22	24
V	67.34	87.61	107.83	128.07	148.32	168.56	188.82	209.06	229.29	249.55
KS	2.70	3.50	4.30	5.10	5.85	6.65	7.40	8.20	8.95	9.75

Serie 45-51-635 Series

	MODELLO - MODEL									
	45-51-635 06	45-51-635 08	45-51-635 10	45-51-635 12	45-51-635 14	45-51-635 16	45-51-635 18	45-51-635 20	45-51-635 22	45-51-635 24
A	518	518	518	518	518	518	518	518	518	518
B	267	369	471	572	674	775	876	979	1079	1179
N.	6	8	10	12	14	16	18	20	22	24
V	73.15	95.33	117.50	139.69	161.88	184.07	206.26	228.45	250.64	272.82
KS	3.00	3.85	4.70	5.60	6.45	7.30	8.15	9.05	9.90	10.75

I modelli di condensatori su fondo giallo sono quelli di normale produzione, gli altri possono essere forniti su richiesta dei clienti.

Yellow underlined condensers are of standard production, the others may be supplied on Customers' request.

50 HZ MODEL COMPARISON CHART

R-12 MODEL	COOL'G CAPACITY (Kcal / BTU)/Hr	INPUT (WATT)	E.E.R. (BTU/W.Hr)	R-134a MODEL	COOL'G CAPACITY (Kcal / BTU)/Hr	INPUT (WATT)	E.E.R. (BTU/W.Hr)	RECOMMENDED MODEL
VS 24 AJG	48 / 191	82	2.3	VS 24 LAEG VS 28 LAEG	43 / 171 55 / 218	78 80	2.2 2.7	VS 28 LAEG
VS 28 AJG	56 / 222	86	2.5	VS 28 LAEG VS 30 LAEG ²	55 / 218	80	2.7	VS 30 LAEG
				VS 36 LAEG	72 / 288	93	3.07	VS 36 LAEG
VS 36 AJG	75 / 298	99	3.0	NR 45 LAEG	93 / 369	104	3.55	NR 45 LAEG
VC 45 AJG	102 / 405	115	3.5	NR 52 LAEG	113 / 449	119	3.77	NR 52 LAEG
VL 45 AJG	101 / 401	118	3.4					
VC 52 AJG	120 / 476	136	3.5	NR 58 LAEG	124 / 492	130	3.79	NR 58 LAEG
VL 52 AJG	120 / 476	136	3.4					
VC 62 AJG	137 / 544	144	3.8	NR 62 LAEG	134 / 532	132	4.03	NR 62 LAEG
V 62 KEG	138 / 548	148	3.7					
				V 69 LAEG	147 / 585			V 69 LAEG
VC 75 AJG	168 / 667	180	3.7	V 75 LAEG	167 / 663	157	4.22	V 75 LAEG
V 75 KEG	168 / 667	187	3.8					
				V 80 LAEG				V 80 LAEG



R134a, 50Hz/LBP Application

Series	Model	Displacement cc	Motor Type	Compressor Cooling	Refrigerant Control	Oil Charge cc	Weight kg.(lb)	"ASHRAE" Performance												"CECOMAF" Performance				
								Capacity						Power consumption						Capacity				
								Evaporating temp. (°C)						Evaporating temp. (°C)						Evaporating temp. (°C)				
								-30	-25	23.3	-20	-15	-10	-30	-25	23.3	20	-15	-10	-30	25	20	-15	-10
kcal/h	kcal/h	kcal/h	kcal/h	kcal/h	kcal/h	w	w	w	w	w	w	kcal/h	kcal/h	kcal/h	kcal/h	kcal/h								
VS	VS24L	2.42	RSIR	N	C	200	4.8 (10.6)	-	39	43	54	73	94	-	76	78	83	92	100	-	31	43	59	76
	VS28L	2.84	RSIR	N	C	200	5.8 (12.8)	-	48	55	67	92	120	-	78	80	86	95	104	-	39	54	75	97
	VS36L	3.58	RSIR	N	C	200	5.8 (12.8)	-	67	72	88	115	146	-	89	93	100	112	125	-	54	72	93	119
NR	NR45L	4.50	RSIR	N	C	210	8.5 (18.7)	59	84	93	114	146	189	87	100	104	114	126	143	49	67	90	117	149
	NR52L	5.20	RSIR	N	C	210	8.5 (18.7)	75	101	113	135	173	220	98	112	119	128	146	164	61	82	108	140	179
	NR62L	6.22	RSIR	N	C	210	8.8 (19.4)	87	122	134	163	209	267	108	128	132	148	167	190	69	99	131	166	215
V	V75L	7.46	RSIR	F.O	C	390	10.2 (22.5)	110	152	167	204	262	334	127	150	157	172	193	224	87	123	162	212	269

- 1) Performance data were obtained under 230V/50Hz running condition.
- 2) The High Efficiency models "RSCR" can be also available with permanent run capacitor
- 3) Refrigerant Control : C (Capillary tube)
- 4) Voltage range : 197V--264V

Notes

- 1) Capacity Conversion
 $1 \text{ kcal/h} = 3.97 \text{ Btu/h}$
 $1 \text{ kcal/h} = 1.16 \text{ Watt}$
- 2) E.E.R(Btu/Wh) = $\frac{\text{Capacity (kcal/h)} \times 3.97}{\text{Motor input(Watt)}}$
- 3) RSIR = Resistance Start Induction Run
 RSCR = Resistance Start Capacitor Run

Compressor Cooling	Test Conditions	ASHRAE	CECOMAF
N = Natural Convection	Condensing temperature	54.4 °C (130 °F)	55.7 °C (131 °F)
O = Oil Cooling	Gas superheated to	32.2 °C (90 °F)	32.7 °C (90 °F)
F = Fan Cooling	Liquid subcooled to	32.2 °C (90 °F)	55.7 °C (131 °F)
	Ambient temperature	32.2 °C (90 °F)	32.7 °C (90 °F)

TITLE	PERFORMANCE DATA
DWG. NO.	PER - HF5A



• OLP (TEXAS INSTRUMENT)

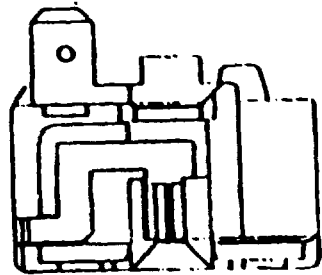

ex) 4TM 330 KFB YY-52

External Terminations (Male Quick Connects)

Denotes Contact Capacity

Designate Disc. Operating Temp. and Tolerance

Three digit Heater Code

Basic Name of Thermal Motor Protector

• PTC Starter

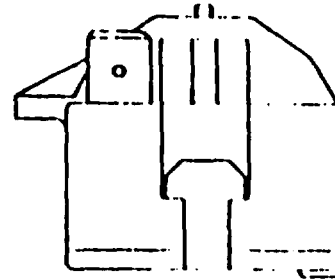

ex) P 6R8 M C

Starting type

Tolerance of the resistance ($\pm 20\%$)

Nominal resistance (6.8 ohms)

PTC Starter

		VS24LAEG	VS28LAEG	VS36LAEG	NR45LAEG	NR52LAEG	NR62LAEG	V75LAEG	
O	TYPE (Part No)	4TM117SFB (3C00301D)	4TM149NFB (3C00301A)	4TM149NFB (3C00301A)	4TM166RFB (3C00301H)	4TM232NFB (3C00301G)	4TM205RFB (3C00404L)	4TM276LFB (3C00301F)	
	OPEN TEMP. (°C)	135 $\begin{smallmatrix} +10 \\ -5 \end{smallmatrix}$	120 $\begin{smallmatrix} +10 \\ -5 \end{smallmatrix}$	120 $\begin{smallmatrix} +10 \\ -5 \end{smallmatrix}$	130 $\begin{smallmatrix} +10 \\ -5 \end{smallmatrix}$	120 $\begin{smallmatrix} +10 \\ -5 \end{smallmatrix}$	130 $\begin{smallmatrix} +10 \\ -5 \end{smallmatrix}$	110 $\begin{smallmatrix} +10 \\ -5 \end{smallmatrix}$	
	CLOSE TEMP. (°C)	61 ± 9	61 ± 9	61 ± 9	61 ± 9	61 ± 9	61 ± 9	61 ± 9	
L	ULTIMATE TRIP CURRENT (A)	0.8~1.2	0.95~1.2	0.95~1.2	1.1~1.44	1.57~1.90	1.6~2.0	1.62~2.0	
P	SHORT TIME	CURRENT (A)	3.5	4.3	4.3	4.92	7.47	6.46	9.09
		FIRST TRIP TIME (SEC)	10 ± 5	10 ± 5	10 ± 5	10 ± 5	10 ± 5	10 ± 5	10 ± 5
		RECOVERY TIME (SEC)	MIN. 50	MIN. 50	MIN. 50	MIN. 50	MIN. 50	MIN. 50	MIN. 50
P	TYPE (Part No)	P220MC (2C00146A)	P220MC (2C00146A)	P220MC (2C00146A)	P220MC (2C00146A)	P330MC (2C00146C)	P330MC (2C00146C)	P470MC (2C00146U)	
T	RESISTANCE AT 25 °C (Ω)	22 $\pm 20\%$	22 $\pm 20\%$	22 $\pm 20\%$	22 $\pm 20\%$	33 $\pm 20\%$	33 $\pm 20\%$	47 $\pm 20\%$	
C	Max. VOLTAGE (Vrms)	300	300	300	300	355	355	400	
	Max. CURRENT (Arms)	7	7	7	7	6	6	5	

TITLE	ELECTRICAL PARTS
DWG. NO.	ELE-1510



شرکت ارج سازه ها
ARJ CORPORATION

BIBLIOGRAPHY

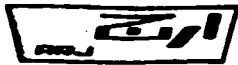

BIBLIOGRAPHY

- 1) Danfoss compressor : Hermatic systems for R134a
N.80.BI.02 Danfoss 1990
- 2) Deawoo technical brief (Dwar - 10-1993)
- 3) R134a design : Sharif university Tehran papar 1993
- 4) DKK-Foron Seminar on design 1995
- 5) UNDP preparation of Ind. Inv. studies 1992
- 6) Iso 7371 Ref.Performance 1985
- 7) Necchi , Ozone friendly 1993
- 8) Gold star , new enviroment 1994
- 9) Synopsis on R134a design - compard to R12 : Sharif
university 1994