



TOGETHER
for a sustainable future

OCCASION

This publication has been made available to the public on the occasion of the 50th anniversary of the United Nations Industrial Development Organisation.



TOGETHER
for a sustainable future

DISCLAIMER

This document has been produced without formal United Nations editing. The designations employed and the presentation of the material in this document do not imply the expression of any opinion whatsoever on the part of the Secretariat of the United Nations Industrial Development Organization (UNIDO) concerning the legal status of any country, territory, city or area or of its authorities, or concerning the delimitation of its frontiers or boundaries, or its economic system or degree of development. Designations such as “developed”, “industrialized” and “developing” are intended for statistical convenience and do not necessarily express a judgment about the stage reached by a particular country or area in the development process. Mention of firm names or commercial products does not constitute an endorsement by UNIDO.

FAIR USE POLICY

Any part of this publication may be quoted and referenced for educational and research purposes without additional permission from UNIDO. However, those who make use of quoting and referencing this publication are requested to follow the Fair Use Policy of giving due credit to UNIDO.

CONTACT

Please contact publications@unido.org for further information concerning UNIDO publications.

For more information about UNIDO, please visit us at www.unido.org

23031

Biotechnological application of enzymes for making paper pulp from green jute/kenaf

Final Report

Project code : FC/RAS/00/153

Duration : 1 October 2000 – 30 November 2003

This report : Final Report January 2004

Project management : M.H.B. Snijder Msc

Project Group

: S.J.J. Lips

: R.H.W. Maas

: R.G.M. Op den Kamp

: Dr. Ir. H.C.P.M. van der Valk

: Dr. Ir. E. de Jong

Report 93

Colophon

Title Biotechnological application of enzymes for making paper pulp from green jute/kenaf
Author(s) M.H.B. Snijder, S.J.J. Lips, R.H.W. Maas, R.G.M. Op den Kamp, Dr. Ir. H.C.P.M. van der Valk, Dr. Ir. E. de Jong
A&F number 093
ISBN-number
Date of publication February 2004
Confidentiality Yes
Project code. FC/RAS/00/153

Agrotechnology & Food Innovations B.V.
P.O. Box 17
NL-6700 AA Wageningen
Tel: +31 (0)317 475 024
E-mail: info.agrotechnologyandfood@wur.nl
Internet: www.agrotechnologyandfood.wur.nl

© Agrotechnology & Food Innovations B.V.

Alle rechten voorbehouden. Niets uit deze uitgave mag worden verveelvoudigd, opgeslagen in een geautomatiseerd gegevensbestand of openbaar gemaakt in enige vorm of op enige wijze, hetzij elektronisch, hetzij mechanisch, door fotokopieën, opnamen of enige andere manier, zonder voorafgaande schriftelijke toestemming van de uitgever. De uitgever aanvaardt geen aansprakelijkheid voor eventuele fouten of onvolkomenheden.

All right reserved. No part of this publication may be reproduced, stored in a retrieval system of any nature, or transmitted, in any form or by any means, electronic, mechanical, photocopying, recording or otherwise, without the prior permission of the publisher. The publisher does not accept any liability for the inaccuracies in this report.

This report is authorised by: M.H.B. Snijder



The quality management system of Agrotechnology & Food Innovations B.V. is certified by SGS International Certification Services EESV according to ISO 9001:2000.

1 Executive Summary

1.1 Aims

The objectives of the tasks of Agrotechnology & Food Innovation (formerly ATO) in the project are:

- to determine at laboratory level the best conditions for producing high-yield pulps from whole jute for utilisation in wood containing papers,
- to test the potential of using recommended enzyme recipes in both extruder and refiner processes in terms of pulp quality, chemicals and energy consumption, brightness and production cost,
- to evaluate the potential of a micro-biological pre-treatment with selected strains of fungi,
- to establish process conditions for pilot confirmatory trials,

1.2 Results

1.2.1 Refiner versus extruder-pulping

During the first year of the project two methods of pulping sun-dried jute (refining and extruding) have been investigated. Obviously, processing jute pulp with a refiner was more efficient than using extruder technology. This is expressed in the mutual differences in the total power consumption. For the applied material, both root and bark fibres, the milling performance in the refiner is better than in the extruder. This also gives better mechanical and structural performances of the jute pulp and paper. However, extruder-pulping resulted in improved bleaching efficiency compared with refiner-pulping due to the continuous and more homogeneous mixing of the bleaching agent (ATO Progress Report 1).

1.2.2 Enzymatic treatments

In the second year the attention was focused on enzymatic and microbiological treatments of the extruded and refined pulps. Extruded/refined pulp (XRP), treated with the recommended laccase recipe, showed an increased brightness of 2 to 3 points, corresponding with up to 1% less hydrogen peroxide addition. Strength properties were not impaired.

With the suggested xylanase recipe the brightness of green jute paper, made from Alkaline Peroxide Extruded Pulp (APXP), was also increased by 1 ISO%, replacing 1 to 2 % of hydrogen peroxide in post bleaching. However, the treatment causes significant losses of fines. This decreases the beating degree but impairs strength properties. This problem has to be solved by e.g. treating the jute in a more coarse stage.

It has been shown that enzymes may be of help in improving the brightness when making paper from green jute chips (ATO Progress Report 2).

Microbiological pre-treatments of RMP

1.3 Effects

Microbiological pre-treatments of chopped green jute (simulated Refined Mechanical Pulp), resulted in energy savings of up to 30%, or improvements of strength properties at equal specific energy. Moreover, *Forus lignosus* pre-treatment leads to an improvement in brightness of 3 ISO%, whereas *Phanerochaete dryosporium* leads to an increase in strength properties at the same beating degree. In all cases less shives were detected in the paper sheets. Losses of around 14% were measured.

1.3.1 Variability

The variation between the treatments was relatively high due to the heterogeneity of the jute material. Further research is therefore needed to solve the problem of sampling taking. Secondly, variation in the growth of the fungi in the various Erlenmeyer flasks needs to be controlled by using larger volumes, smaller pieces of jute or even more fragmentation of the jute substrate. *Forus lignosus* was selected for further studies as treatment with this organism gave the best results on energy saving and improvement on brightness.

1.3.2 Selected fungus

In the third year studies focussed on using the selected fungal strain *F. lignosus* to pre-treat green jute chips. This fungus has proven to give most consistent effects. The first study was a repetition of the pre-treatment of a simulated RMP pulp, produced in a PFI mill. The results confirmed the conclusions of the previous experiments: The pre-treatment with *F. lignosus* gives an energy saving of about 10 to 20 % and a small increase in brightness of 1 to 2 ISO%. Subsequent studies towards optimum incubation times showed that a minimum period of 12-14 days of incubation with the fungus was needed for an optimal effect. In the various laboratory-scale experiments fungal growth differed. However, within the range of 10-14 days no significant differences in loss were observed. In some experiments 10-day incubations showed lower effects on energy savings, so incubation periods of 12-14 days are advised. The extra weight loss due to the fungal pre-treatment is about 13 %.

1.3.3 Microbiological pre-treatments of APMP

In a further study simulated Alkaline Peroxide Mechanical Pulps (APMP) were produced in a PFI mill and pre-treated with the fungus *Forus lignosus*. Initially, no statistically significant differences between treated and untreated pulp were found.

Because of the great number of different processing steps that are needed to produce a sheet of paper of jute, the variability is high. The steps include size reduction, pre-treatment, washing, bleaching, beating and making of the paper. Particularly the size reduction is an important step in this procedure. If particles are too large in size, the

fungal pre-treatment and the bleaching can be hampered. Besides, long bast fibres tend to form flocs that create extra variation in the ratio of core and bast fibre. It is expected that this last point is not a problem if the process is eventually carried out at industrial scale.

For the small-scale experiments a more homogeneous size distribution and a further reduction to smaller pieces would be beneficial. This was done in extra studies. After the size reduction, a pre-refining step was added to the procedure. This step resulted in a more homogeneous material and an easier running of the PFI-mill. In this test a clear difference between treated and untreated pulps evolved. The APMP-process consumes about 25% less energy and results in better paper properties than the RMP process, whereas the fungal treatment saves at least an extra 5% on top of this. This may increase even further to 20% with optimised beating times.

In both types of simulated APMP studies there were no differences in the brightness of the treated and untreated pulps. Probably, the small brightening effect of *F. lignosus* is overshadowed by the brightening effect of the peroxide treatment. The average brightness after pre-refining was 63.2 ISO %, which is 2.7 % higher than in the first APMP test. Apparently, the extra size reduction in the pre-refining in combination with a higher consistency during bleaching was beneficial.

In the last APMP test, the fungal treatment raised the weight loss from 16 to 21 %. The extra 5% weight loss is low compared with the extra weight loss that fungal treatment caused in the RMP experiments. This means that the main part (60%) of the losses caused by the fungal treatment in RMP process occurs in an APMP process anyway.

Contrary to RMP pulps the strength properties and brightness were raised by the alkali peroxide process to a level that makes it possible to use this pulp for the production of newsprint. The brightness was increased from below 40 ISO % to well above 60 ISO %. After the laboratory scale experiments with the PFI mill, APMP tests were carried out on a larger scale with a 12" pressurised refiner system. In these tests an average yield after bleaching, refining and washing of 79% was obtained, which is comparable with the described laboratory experiments and about 6% lower than for e.g. an aspen CTMP pulp. The produced pulps had brightnesses of around 63% and the breaking length was around 4 km. This brightness exceeds the brightness of the initial extruder-pulp significantly. It makes the pulps suitable for use in newsprint. The specific energy needed to produce these pulps was around 500 kWh/ton, which is only 25% of the production of a TMP pulp for newsprint from wood.

The first attempt to test the fungal pre-treatment in a pilot scale trial resulted in substantial problems with inhomogeneous fungal growth in the incubation vessels. Black liquor analyses as planned for these trials could therefore not be executed. The research on large-scale fungal treatments needs more attention than originally expected. However, such solid state studies were not part of the project and within the allocated budget (ATO Progress Report 3).

1.4 Conclusions

- | |
|--|
| <ul style="list-style-type: none">• Refiner-pulping of jute is superior to extruder-pulping regarding energy consumption and mechanical and structural performance of pulp and paper. |
| <ul style="list-style-type: none">• Enzymatic pre-treatment, as performed with the pre-described procedures, slightly improves the brightness of RMP jute paper. |
| <ul style="list-style-type: none">• When producing RMP at lab-scale, a pre-treatment with <i>F. lignosus</i> results in lower specific energy and a 1 to 2 ISO % higher brightness. |
| <ul style="list-style-type: none">• APMP process results in better paper quality and has a lower energy demand than the RMP process.• APMP pulp from green jute can be produced with only 25% of the energy needed to produce a TMP pulp for newsprint from wood.• When producing APMP at lab-scale, a pre-treatment with <i>F. lignosus</i> results in a further decrease of specific energy, but not in a higher brightness. |
| <ul style="list-style-type: none">• Further size reduction by means of a pre-refining step results in better reproducible fungal pre-treatment experiments and probably a more efficient bleaching step.• The main part of the losses caused by the fungal treatment in an APMP process occurs anyway in an alkaline bleaching step.• The yield of the APMP from green jute after fungal pre-treatment, bleaching and washing is about 79%, being 5% lower than APMP that is not treated with fungi. |
| <ul style="list-style-type: none">• The strength properties of RMP derived jute paper are too low to make newsprint.• APMP pulps from green jute are suitable for the production of newsprint. |
| <ul style="list-style-type: none">• Scaling-up of the fungal treatments faces specific solid-state fermentation obstacles that need to be investigated in more detail before industrial implementation is feasible. |

Content

1 Executive Summary	3
1.1 Aims	3
1.2 Results	3
1.2.1 Refiner versus extruder-pulping	3
1.2.2 Enzymatic treatments	3
1.3 Effects	4
1.3.1 Variability	4
1.3.2 Selected fungus	4
1.3.3 Microbiological pre-treatments of APMP	4
1.4 Conclusions	6
2 First year report	11
2.1 Aim	11
2.2 Objectives	11
2.3 Progress	12
Theoretical background	13
2.4 Pulping	13
2.4.1 Refining	13
2.4.2 Extruding	15
2.5 Bleaching	16
2.5.1 Peroxide bleaching	18
Experimental	20
2.6 Raw materials	20
2.7 Pretreatment	20
2.8 Extruding	20
2.9 Refining and bleaching	21
2.10 Posttreatment	22
2.11 Determination of the mechanical and optical properties	22
Results and discussion	23
2.12 Extruder and refiner pulping data	23
2.12.1 Extruder pulps	23
2.12.2 Refiner pulps	25
2.12.3 Comparison extruder versus refiner processing	26
2.12.4 Comparison extruder versus refiner pulp properties	27
Literature	28
3 Second-year Report	29
3.1 Summary	29
3.2 The effects of enzymatic pre-treatment on hydrogen peroxide bleaching of Extruder Refiner Pulp (XRP)	30
3.2.1 Experimental	30

3.2.2	Results	31
3.2.3	Conclusions	34
3.3	The effects of enzymatic pre-treatment on hydrogen peroxide post-bleaching of Alkaline Peroxide Extruder Pulp (APXP)	35
3.3.1	Experimental	35
3.3.2	Results	36
3.3.3	Conclusions	38
3.3.4	Recommendation	39
3.4	The effects of microbiological pre-treatment on simulated refiner mechanical pulp of green jute	40
3.4.1	Material and methods	40
3.4.2	Results	41
3.4.3	Conclusions	45
3.4.4	Recommendations	45
Appendix 1		46
Appendix 2		48
Appendix 3		49
ATO Work Plan for 2003		51
4	Third-year report	52
4.1	Management Summary	52
4.2	The effects of microbiological pre-treatment on simulated refiner mechanical pulp (RMP) of green jute	55
4.2.1	Material and methods	55
4.2.2	Results	56
4.2.3	Conclusions	58
4.3	The effect of incubation time of the <i>F. lignosus</i> pre-treatment on simulated refiner mechanical pulp (RMP) of green jute. (I)	59
4.3.1	Material and methods	59
4.3.2	Results	59
4.3.3	Conclusions	61
4.4	The effect of incubation time of <i>F. lignosus</i> pre-treatment on simulated refiner mechanical pulp (RMP) of green jute. (II)	62
4.4.1	Material and methods	62
4.4.2	The weight loss after pre-treatment and washing was on average 10.9 % higher for the treated green jute (Table 4.2). In both tests the pre-treatment caused an averaged extra loss of 12.5 %.	62
4.4.3	Conclusions	64
4.5	Microbiological pre-treatment of APMP-PFI pulp (I)	65
4.5.1	Material and methods	65
4.5.2	Results	66
4.5.3	Brightness	67

4.5.4	Conclusions	70
4.6	Microbiological pre-treatment of APMP-PFI pulp (II)	71
4.6.1	Material and Methods	71
4.6.2	71	
4.6.3	Results	71
4.6.4	Conclusions	74
4.7	Production of APMP pulps on a 12"inch refiner	75
4.7.1	Material and methods	75
4.7.2	Pre-treatment	75
4.7.3	Bleaching and first stage refining	75
4.7.4	Washing	75
4.7.5	Atmospheric refining	76
4.7.6	Making of hand sheets	76
4.8	Results	77
4.8.1	Pre-washing, refining and washing	77
4.8.2	Pulp and Paper properties	78
4.8.3	Conclusions	80
Appendix 1: Test results simulated RMP in PFI-mill experiment		81
Appendix 2: Graphic presentation of the test results simulated RMP in PFI-mill experiment		83
Appendix 2: Graphic presentation of the test results simulated RMP in PFI-mill experiment		84
Appendix 2: Graphic presentation of the test results simulated RMP in PFI-mill experiment		85
Appendix 3: Test results of the first experiment on the incubation time		86
Appendix 4: Graphic presentation of the test results of the first experiment on the incubation time		88
Appendix 4: Graphic presentation of the test results of the first experiment on the incubation time		89
Appendix 5: Test results of the second experiment with different the incubation time		90
Appendix 6: Graphic presentation of the test results of the second experiment with different the incubation time		91
Appendix 6: Graphic presentation of the test results of the second experiment with different the incubation time		92
Appendix 7: Test results of the first experiment of APMP simulated PFI-mill		93
Appendix 8: Test results of the second experiment of APMP simulated PFI-mill		94

Appendix 9: Graphic presentations of the test results of the second experiment of APMP simulated PFI-mill	95
Appendix 9: Graphic presentations of the test results of the second experiment of APMP simulated PFI-mill	96
Appendix 10: Handsheet properties	97
Appendix 11 Experimental Procedures	99

2 First year report

2.1 *Aim*

The project is an international co-operation of institutes from Bangladesh, China, India, France and The Netherlands. It aims at developing a technology for the use of green jute as raw material for the production of pulp for paper. It intends to reduce the consumption of chemicals through the introduction of eco-friendly production processes, reduce energy- and production costs. This new technology is expected to achieve a breakthrough in opening up a sector for the jute industry which would generate sustained demand for raw jute with a consequent result of stabilising structural conditions in markets for jute fibres and hence stable source of jute farmers' income.

The project will conduct a comparative study of different micro-organisms now being used in various wood-based pulp and paper mills and isolate and develop suitable ones for jute bio-pulping. It is also envisaged to manage the black liquor produced during processing ensuring that the technology will be environmentally sustainable.

Large-scale application trials will be carried out in Bangladesh, China and India and workshops and training programmes will be organised to disseminate project results. The project is expected to have significant medium to long-term impact on socio-economic development of the producing countries particularly on jute farmers and in providing job opportunities for workers.

2.2 *Objectives*

The objectives of the study to be carried out by ATO are:

- ✓ to determine at laboratory level the best conditions for producing high yield pulps from whole jute for utilisation in wood containing papers such as newsprint, magazines and coated paper,
- ✓ to compare extruder and refiner processes and the potential benefits of using commercial and newly developed enzymes in terms of pulp quality, energy consumption, chemical consumption in pulping and bleaching, brightness of the pulps, and production costs; and
- ✓ to establish the best process conditions for pilot confirmatory trials with extruder/refiner at CTP.

The scope of service is as follows:

- 1) Laboratory extruder (10 kg/h) pulping and bleaching with and without commercial enzymes including reference, pre-treatment, pulping and post-treatment trials and determination of pulping and bleaching yields, chemicals and energy consumption,

physical and chemical characteristics of the unbleached and bleached pulps at 4-5 levels refining (°SR and mCSF).

- 2) Laboratory refiner pulping and bleaching with and without commercial enzymes using the best process conditions determined under 1) with determination of pulping and bleaching yields, chemicals and energy consumption, physical and chemical characteristics of the unbleached and bleached pulps at 4-5 levels of refining (°SR and mCSF).
- 3) Laboratory extruder pulping and bleaching with and without newly developed (by IJO enzyme plant) enzymes using the best process conditions determined under 1) with determination of the same process parameters and pulp characteristics indicated in this item.
- 4) Laboratory refiner pulping and bleaching with and without newly developed enzymes using the best process conditions determined under 3) and the same process parameters and pulp characteristics determination as indicated under 1).
- 5) Effluent analysis for the best results using commercial and newly developed enzymes
- 6) Prepare a final report including indications on operational costs for the best results with commercial and newly developed enzymes using extruder and refiner, comparison with commercial high yield pulps and recommendations of process parameters to be used in the pilot/commercial trials on extruder and refiner to be carried out by CTP and CPPRI respectively.

2.3 *Progress*

During the first reporting period reference experiments have been carried out. Based upon sun-dried jute, whole stem, extruder- and refiner pulping have been performed. Resulting pulp and paper properties have been established. This report describes the results.

Theoretical background

In this chapter an introduction is given to the different pulping, bleaching and delignifying stages used in this project. First the pulping stages are discussed, being refining and extruding. The methods are referred to as (chemi-) mechanical pulping process. In the second paragraph an introduction is given to the bleaching of mechanical pulps.

2.4 *Pulping*

Two methods for pulping of sun-dried jute, whole stem have been investigated during the first year of this project. In this paragraph a small introduction to each pulping method is given.

2.4.1 *Refining*

Refining pulping, also known as mechanical and high yield pulping, is a defibration method which uses mechanical action to separate the fibres in wood and annual-plants from each other. Mechanical pulps distinguish from chemical pulps by their high yield (85 to 95%) and lignin content. This high lignin content causes yellowing and weak bonding properties of the fibres to each other. This kind of pulp contains a high amount of shortened fibres and fines. Papers containing such fibres have a smoother surface and a higher opacity. Refiner mechanical pulping (RMP) started in the mid 1950s [1]. In a refiner the raw material is fed between two discs on which plates with bars and grooves are mounted. At least one of the disks is rotating. The design of the plates and grooves determines the quality of the pulp and is usually found by trial and error. There is not one pattern that is suited for all wood species. RMP pulps were significantly stronger than the traditional groundwood pulps which caused the number of refiner mills to increase steadily.

In the mid 1960s the development work started on the Thermo Mechanical Pulping process, (TMP) which involved a pressurised first-stage refining. The higher temperature gives a better separation and less shortening of the fibres, resulting in a stronger pulp with less shives and a lower bulk.

It did not take long before chemicals were introduced in this process. By a small addition of sodium sulphite the lignin is sulphonated and weakened, resulting in fewer shives, longer fibres and better bonding in the paper web. These so-called Chemi Thermo Mechanical pulps (CTMP) still have the characteristics of mechanical pulps. Another CTMP method uses sodium hydroxide instead of sodium sulphite. These pulps are called alkaline thermomechanical pulps (ATMP).

The latest development is to replace the sulphite by alkaline and peroxide which is more environment friendly because of the lack of sulphur. Alkaline Peroxide Mechanical Pulping (APMP) is best suited for low density hardwoods. With the APMP process

fully bleached pulp can be produced with less energy and lower capital investment [3,4]. Generally, the quality of APMP pulps is similar or better than the quality of CTMP pulps.

At A&F extensive research has been done concerning RMP, TMP and ATMP pulping of various agro-based materials.

2.4.2 Extruding

The basic principles of extrusion pulping have been developed during the last two decades in France, with successful results on pilot and industrial applications processing annual plants like cotton, hemp and flax. Extrusion pulping can be a mechanical or chemi-mechanical pulping method, and is based on the use of a co-rotating twin screw extruder as the main pulping device. Figure 2.1 shows the basic operating principle of a pulping extruder. The pulping extruder consists of an eight-shaped barrel with two co-rotating intermeshing screws inside. Fibrous material is fed into the barrel by transport screws. Further down the barrel a screw with its flight pitch reversed (a Reverse Screw Element or RSE) causes severe compression of the fibre mass. The generated pressure forces the fibre mass to flow through slots machined in the RSE flights, where a high shear field causes defibration and cutting of the fibres. Excess water pressed out of the fibre mass is extracted through barrel filters placed upstream from the RSE. The pressure drop and friction created in passing a RSE heats the pulp mass and provides rapid impregnation of liquids supplied through an injection port downstream from the RSE. The combination of transport screw, reverse screw, filter and injection port constitutes one defibration zone. A pulping extruder can be set up to hold four separate defibration zones. The pressurised fibre mass in the RSE separates the liquids in the subsequent zones from each other. It is thus possible to create a sequence of different operations within one machine treatment. Additional heating of the pulp is provided by steam injection.

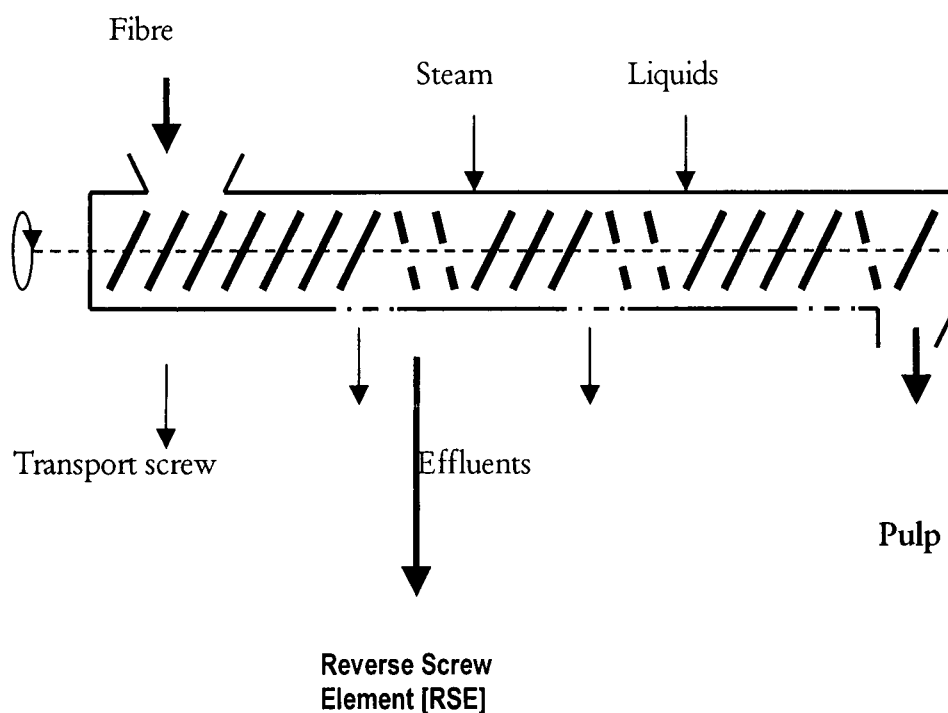

Figure 2.1 The basic mechanism of extrusion pulping

Extrusion pulping has proved particularly useful for very long fibre materials, inherently of vegetable nature. At this moment some twenty industrial installations are in operation. In the process proposed by ATO the fibres are subjected to cold alkaline impregnation (“cold soda”) and subsequent washing before entering the extrusion process, thereby raising the yield from 50 to 80%, and thus reducing the amount of waste material with 60%. Further, the original BiVis (French for twin-screw) process was designed with two pulping extruders in series, the first for impregnation and partly cutting fibres, the second for bleaching and additional cutting. Often intermediate retention chests are added to extend the reaction time for cooking or bleaching chemicals. The bleaching principle used is similar to the APMP process for bleached mechanical woodpulp.

2.5 *Bleaching*

There is a clear distinction between bleaching of mechanical pulps and bleaching of chemical pulps. While during bleaching of mechanical pulps coloured chemical groups are changed into non-coloured groups, during chemical bleaching the coloured groups are completely removed.

The objective of bleaching of mechanical pulps is to obtain a high paper whiteness, while preserving the pulp yield. Generally as an index of paper whiteness the brightness of a pulp is used. In this report brightness is defined as the ISO brightness measured according to ISO standards 2470 and 2471.

Brightness is a measurement of the reflectance of visible blue light of an opaque stack of paper. It is a function of the concentration of chromophoric groups in the pulp, because chromophoric groups by definition absorb light at a certain wavelength. A small amount of chromophoric groups can already significantly reduce the brightness of a pulp. Hereafter this is explained with a small model.

The Kubelka-Munc equation defines the brightness as a function of the path a light ray is following through a paper layer.

$$\frac{B}{100} = 1 + \frac{k}{s} - \sqrt{2 * \left(\frac{k}{s}\right) + \left(\frac{k}{s}\right)^2}$$

where

- B = brightness [%]
- k = likelihood of absorption
- s = likelihood of direction change

The likelihood of absorption is proportional to the chromophore concentration, the likelihood of the direction change is determined by the fibre dimensions and the degree of interfibre bonding.

For a given pulp the parameter "s" is assumed constant during bleaching, because bleaching is supposed to have little influence on the fibre dimensions and the degree of interfibre bonding. Using these assumptions and the Kubelka-Munc equation the brightness of a pulp as a function of the removed fraction of the chromophores can be calculated. In figure 2.2 the brightness of a pulp as a function of the fraction of the chromophores removed, is given for a pulp with a starting brightness of 40, 50 and 60.

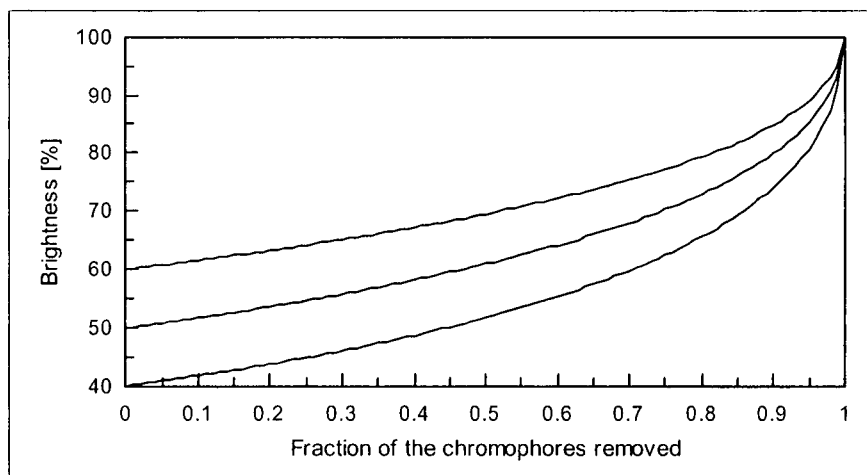

Figure 2.2 Brightness as a function of the chromophore removal

Obviously to obtain a brightness of >85 % different percentages of chromophores removal have to be obtained for pulps with different starting brightness. For a pulp with brightness 60 % 90,1 %, for a pulp with brightness 50% 94,7% and for a pulp with brightness 40% 97,1% of the groups have to be removed. If one also assume that an unbleached mechanical pulp with brightness 40 contains more chromophores than a pulp with brightness 60 it becomes clear that bleaching a pulp with an already high brightness is much more effective than bleaching a pulp with a low brightness.

From the components present in vegetable fibres, lignin is supposed to contain the largest amount of chromophores. During chemimechanical pulping in contrast with chemical pulping the amount of lignin present in the fibres is almost unchanged, therefore to brighten the pulp the colour-contributing groups have to be chemically changed into groups that do not colour the pulp.

From this introduction it can be concluded that the pulping method and the bleaching method both influence the brightness. The bleaching can therefore not be optimised without taken into consideration the effect the pulping has on the chromophores: An

optimisation of the brightness of a jute fibre pulp has to include both the bleaching and the mechanical pulping.

2.5.1 *Peroxide bleaching*

The normal components of a peroxide bleaching liquor are hydrogen peroxide, sodium hydroxide, sodium silicate, magnesium sulphate and DTPA. In pulping a bleaching with hydrogen peroxide is referred to as a “P” stage.

Hydrogen peroxide provides the active bleaching species, the perhydroxylion. Sodium hydroxide increases the pH and thereby the perhydroxylion concentration. Sodium silicate stabilises the bleach liquor, works as a buffer and provides additional hydroxide. Magnesium sulphate can be needed when the water hardness is insufficient for bleach liquor stabilisation. Before the actual bleaching DTPA is used as a chelant to remove metal-ions. When DTPA is used in a separate stage prior to the bleaching it is referred to as “Q” stage.

A Q stage normally consists of a one hour treatment of the pulp at elevated temperature (70°C) with DTPA concentrations of 0.1-0.5 wt%. Afterwards the pulp is washed to remove the metal-DTPA complexes from the pulp.

The influence of important process parameters on peroxide bleaching is discussed below.

Effect of temperature

The chemical reactions during peroxide bleaching are diverse. The reaction temperature during peroxide bleaching does not only influence the reaction velocities, but also influences the selectivity of the reactions. At high temperatures (>100°C) decrease of the pulp yield is expected. Above 130°C the hydrogen peroxide is decomposing quickly.

Effect of consistency

Generally hydrogen peroxide bleaching is done at low, middle or high consistency, respectively 10%, 20% or 30%. The best results are obtained for high consistency bleaching which is clear from a chemical point of view: for a given hydrogen peroxide dosage the actual concentration is higher at higher consistencies. A gain in brightness of several percentages can be reached by changing to high consistency bleaching. However especially at small scale the mixing of the chemicals can be problematic at high consistency, which might lead to inhomogeneously bleached material.

Effect of multistage peroxide bleaching

A gain in brightness can be obtained by using a two stage peroxide bleaching. This effect can be explained by refreshment of the bleaching chemicals, an increase of the pH and

loss of polluting components. In the actual process a second gain can be achieved by recycling unused chemicals.

Effect of pH

A pH between 10 and 13 is needed to obtain the perhydroxylion from peroxide. During bleaching the pH drops. A balance has to be found between the gain of perhydroxyl concentration at high pH and the yellowing of the pulp at high alkaline concentrations.

Effect of transition metals

Thermal ageing of mechanical pulps can take place in the manufacturing process itself, during the pulp storage, and in the finished paper product. The colour formation seems to be due to autooxidation processes of catechols and hydroquinones, resulting in the formation of the corresponding quinones [5]. In the absence of light, these reactions proceed through phenolate anion intermediates, making them dependent on pH. The presence of certain transition metal ions, such as copper or manganese, accelerates the reactions. A simple way of reducing the autooxidation of mechanical pulps is by addition of sulfite at a pH of around 5 – 6. The simultaneous presence of a chelating agent such as DTPA or EDTA prevents autooxidation of the sulfite and leads to long-term stabilization [6].

Experimental

2.6 *Raw materials*

Sundried jute sticks, whole stem, harvest Bangladesh 2000, were provided by the Project Leader. The sticks had an average length of 50 cm. To reduce length, they were processed by a standard woodchipper first. Next, the material was chopped to a length of 6.25 mm by means of a guillotine chopper.

2.7 *Pretreatment*

The fibres are impregnated with 0.1 M sodium hydroxide with a 1:10 dry fibre : water ratio corresponding to 4% dissolved NaOH on dry matter fibre. As a chelant 0.1% on dry fibre of DTPA is added. The impregnation is done overnight (16 hours) at room temperature.

Before extruder pulping experiments, the liquid was allowed to drain after the impregnation through a perforated screen for 30 minutes. After draining the impregnated fibres were preheated with saturated steam at atmospheric pressure.

Before refiner pulping experiments, an additional press stage was necessary to remove unwanted liquid components from the drained pulp.

2.8 *Extruding*

The pulps are extruded in one pass at four to five stages, the bleaching chemicals are injected and mixed with the pulp at the end the pass. A more detailed description of the used procedures extruding the fibres is given below.

The impregnated, preheated fibre was introduced into a modified Clextral BC45 extruder manually. The pulp mass output was recorded every 30 second together with the motor power, thus giving an almost continuously reading of the specific energy consumption of the pulp. Steam is injected into the extruder to supply additional heat to the pulp. At the end of the extruder the bleaching chemicals are injected. Due to the applied screw configuration the chemicals are more ore less thoroughly mixed with the pulp.

For all trials we virtually divided the extruder in three successive sections. The first section consists of the inlet of the extruder, transport screws and an reverse screw element (RSE) to defibrate and cut the fibres. In this stage a press action was applied to remove unwanted liquid components from the drained pulp. Upstream of the RSE an outlet for excess water is placed. The second section consists of a steam inlet, transport screws, an RSE and a filter. The filter is placed upstream from the RSE to remove

excess water. The third section consists of transport screws, an inlet for the bleaching chemicals and an RSE or kneading elements to mix the chemicals with the pulp. At the end of the third section self wiping screws transport the pulp to the outlet of the extruder. The used screw configuration are given in Table 2.1.

Table 2.1 Screw configuration of the pulping trials

Pass 1		
Section 1	Section 2	Section 3
-25H10	-15H8	-15H12

The codes used for the RSE elements are the pitch [mm] of the element, the orientation of the slots (helical) and the slot width [mm]. The kneading element consists of 20 successive rings that are placed off centre on the screw axle. A positive flight as indicated by kneading+ is created by placing the rings on the axle at different angles. The positive flight reduces significantly the strain between the extruder barrel and the kneading elements.

2.9 Refining and bleaching

After the first refining stage all pulps were bleached batch-wise in one step. In all processes the same bleaching chemical composition was used. The chemicals for the bleachings are given in table 2.2. Before bleaching the pulp was washed twice to remove unwanted liquid components.

Table 2.2 Bleaching liquor for the bleaching step

Chemical	% on dry fibre
MgSO ₄	0.1
DTPA	0.05
NaOH	1.4
Silicate	1.0
H ₂ O ₂	2.1

For the regulation of the temperature during the bleaching the following set-up is used:

Bleaching in a closed vessel heated by direct contact with steam

The pulp is put in an open stainless steel vessel, closed with a wooden lid. From the bottom of the vessel saturated steam is introduced heating up the pulp in direct contact. Mixing is done both manually and by the motion created by the steam. The temperature of the pulp is about 70 °C. The temperature differences in the pulp are small. The bleaching is stopped with cold water after 1.5 hrs, reducing the reaction rate. The water is drained using a sieve.

2.10 Posttreatment

After bleaching the pulps are washed 3 times until pH 8 by adding water up to a consistency of about 5 %. The chemicals are allowed to migrate out of the pulp for some time and the water is drained. Finally the pulps are centrifuged to a dry matter content of about 30% and stored in a freezer.

2.11 Determination of the mechanical and optical properties

Hand sheets were formed using a standard sheetformer and pressed twice at 4 bar for 5 minutes. The sheets were conditioned and tested at 23 °C, 50% RH. Mechanical and optical measurements were done using ISO standards. For several pulps the properties depending on beating degree were determined.

Results and discussion

2.12 Extruder and refiner pulping data

2.12.1 Extruder pulps

Pulping experiments were performed in five sequential stages. Typical processing data are given in table 2.3

Table 2.3 Extruder pulping processing data of the different stages

	1st stage	2nd stage	3rd stage	4th stage	5th stage
RPM	150	150	150	150	150
Pulping time [s]	3480	3180	1830	1200	540
Production rate [kg/h]	18.80	14.61	21.29	26.61	31.81
Power consumption [kWh/ton]	310	261	365	435	981

With the exception of the second stage all processing trends are as expected. Under the applied conditions pulping time decreases after each stage, resulting in increasing production rates. In addition, power consumption increases after each stage due to increased opening-up of the jute fibres. The total Power consumption is 2352 kWh/ton. Commercially produced mechanical pulps (flax, hemp) generally have a power consumption of 1200 – 1800 kWh/ton.

In Table 2.4 the yields of the different stages in the process are given.

Table 2.4 Extruder pulping material yield data of the different stages

	1st stage	2nd stage	3rd stage	4th stage	5th stage
Overall yield [kg]	103.9	38.3	27.6	23.6	12.2
Dry matter content [wt.%]	17.5	33.7	39.2	37.6	39.1
Effluent [kg]	24.6	20.8	3.2	<0.5	-

In Table 2.5 resulting paper properties are given.

Table 2.5 Jute paper properties after five extruder pulping stages

Property	2nd stage	3th stage	4th stage	5th stage
beating degree [°SR]	14.1	16.5	19.2	21.1
paper weight [g/m ²]	66.8	67.7	66.7	67.3
thickness [μm]	321.6	282.1	261.8	267.4
density [kg/m ³]	311.2	354.8	382.4	374.3
breaklength [km]	1.0	1.1	1.4	1.3
stretch at fracture [%]	1.0	1.1	1.3	1.2
T.E.A. index [Nm/g]	0.1	0.1	0.1	0.1
burstindex [kPam ² /g]		Too low to be measured		
tearindex [mNm ² /g]	3.0	3.1	3.5	3.0
SCT index [Nm/g]	8.0	9.0	10.0	9.6
ISO brightness [%]	58.1	58.7	59.2	59.2
opacity [%]	92.1	93.0	93.6	93.9
scatter. coeff. [m ² /kg]	44.1	46.7	49.5	50.1
absorption [m ² /kg]	2.2	2.2	2.3	2.3
yellowness [%]	27.1	26.7	26.1	26.0
porosity [ml/min]		Too high to be measured		
roughness [ml/min] rough side	2203.8	1288.0	1198.8	1802.2
roughness [ml/min] smooth side	2768.4	1525.4	1041.4	982.1
Intern.Bond [J/m ²]	12.52	24.18	35.72	34.71

2.12.2 Refiner pulps

Pulping experiments were performed in four sequential stages. Typical processing data are given in table 2.6

Table 2.6 Refiner pulping processing data of the different stages

	1st stage	2nd stage	3rd stage	4th stage
Disk distance [mm]	0.20	0.10	0.05	0.03
Production rate [kg/h]	21.0	15.0	6.3	12.4
Power consumption [kWh/ton]	203	267	453	431

With the exception of the third stage all processing trends are as expected. Under the applied conditions disk distance needs to be decreased after each stage. In addition, power consumption increases after each stage due to increased opening-up of the jute fibres. Similar behaviour is seen for extrusion pulping. The total Power consumption is 1355 kWh/ton, which is in line with commercially produced mechanical pulps and substantially lower than obtained during extrusion pulping.

In Table 2.7 the yields of the different stages in the process are given.

Table 2.7 Refiner pulping material yield data of the different stages

	1st stage	2nd stage	3rd stage	4th stage
Overall yield [kg]	13.5	6.2	2.3	1.3
Dry matter content start [wt.%]	38.8	32.8	20.7	33.2
Dry matter content end [wt.%]	32.8	20.7	17.9	22.5

In Table 2.8 resulting paper properties are given.

Table 2.8 Jute paper properties after four refiner-pulping stages

Property	2nd stage	3rd stage	4th stage
beating degree [°SR]	25.5	35	47.5
paper weight [g/m ²]	66.1	65.5	67.6
thickness [μm]	259.5	252.2	230.2
density [kg/m ³]	385.6	396.6	435.1
breaklength [km]	2.2	2.4	3.0
stretch at fracture [%]	1.4	1.6	1.8
T.E.A. index [Nm/g]	0.2	0.3	0.4
E-modulus [GPa]	0.0	0.0	0.0
burstindex [kPam ² /g]	1.1	1.4	1.7
tearindex [mNm ² /g]	5.9	6.1	6.1
SCT index [Nm/g]	13.2	14.1	16.8
ISO brightness [%]	45.9	45.7	44.7
opacity [%]	97.2	97.6	98.5
scatter. coeff. [m ² /kg]	45.1	46.4	48.9
absorption [m ² /kg]	6.2	6.7	7.8
yellowness [%]	31.8	30.9	30.1
porosity [ml/min]	5519.3	3174.0	1226.3
roughness [ml/min] rough side	814.1	1210.3	976.2
roughness [ml/min] smooth side	336.5	394.6	289.2
Intern.Bond [J/m ²]	56.1	62	79

2.12.3 Comparison extruder versus refiner processing

Obviously, the use of refiner processing to produce jute pulp has a higher efficiency compared to the use of extruder processing. This is expressed in the mutual differences in the total power consumption. For the applied material, which in this case is a combination of both root and bark fibres, the 'milling performance' is better in the refiner than in the extruder. This results in better mechanical- and structural performances of the jute pulp and paper. On the other hand, using the extruder results in improved bleaching efficiency compared with refiner pulping, due to the continuous and homogeneous mixing of the bleaching agent.

2.12.4 Comparison extruder versus refiner pulp properties

Comparing the differences in pulp and paper properties due to different processing methods the following trends are observed; relative to extruder processed material the refiner processed counterparts:

- ✓ have better mechanical performances
- ✓ have better structural performances, and
- ✓ have worse optical performances

The mechanical- and structural properties of extruder processed jute can be improved by using a different (i.e. tougher) screw configuration. Consequently the energy consumption most likely will increase. Therefore, it is expected that by using a combination of root and bark jute the price/performance ratio of extruder pulping will be higher compared with refiner pulping.

The optical properties of refiner processed jute can be improved in two ways:

- ✓ by bleaching batch-wise by applying more bleaching stages
- ✓ by bleaching continuously *in-situ* during the refining stages

Literature

- [1] Leask, R.A., 1987, Pulp and Paper Manufacture, Vol. 2, Mechanical pulping, The joint textbook committee of the paper industry, Tappi.
- [2] Kurdin, J.A., 1991, International mechanical pulping trends, Tappi Journal, Sept. 1991.
- [3] Cort, C.J., 1991, Alkaline peroxide mechanical pulping of hardwoods, Tappi Journal, June 1991.
- [4] Sabourin, M.J., Presley J.R. 1992, Low Chemical Alkaline Peroxide TMP, A Means of Upgrading Newsprint Mills, Tappi Proceedings 1992 Pulping Conference.
- [5] Gellerstedt, G. in *Wood and cellulosic chemistry*, ed. Hon, D.N.S. and Shiraishi, N., Marcel Dekker Inc. , 2001.
- [6] Gellerstedt, G. et al., Svensk Papperstidn., 86 (15):R157, 1983.

3 Second-year Report

3.1 Summary

A&F has executed 3 main activities in 2002:

1. Testing the effect of an enzymatic pre-treatment on brightness of green jute paper made from Extruded/Refined Pulp (XRP). It turned out that treatment with laccase, results in an increased brightness of 2 to 3 points, corresponding with up to 1% less hydrogen peroxide addition. Strength properties were not impaired. To establish a robust and commercially acceptable treatment further tests are necessary to clarify the contribution of e.g. the cleaning effect of the enzyme-treatment procedure, and to optimise the enzyme concentrations and working conditions.
2. Testing the effect of an enzyme pre-treatment on brightness of green jute paper made from Alkaline Peroxide Extruded Pulp (APXP). In this case a xylanase treatment results in a raise of brightness of 1 ISO%, replacing 1 to 2% of hydrogen peroxide in post bleaching. However, the treatment causes significant losses of fines. This decreases the beating degree but impairs strength properties. This problem has to be solved by e.g. treating the jute in a more coarse stage.
3. Testing the effect of a microbiological pre-treatment of chopped green jute with 3 different strains of fungi. The 3 strains show similar effects on energy savings of up to 30%, or improvements of strength properties at equal specific energy. *F. lignosus* pre-treatment leads to an improvement in brightness of 3 ISO%, whereas *P. drososporium* leads to an increase in strength properties at the same beating degree. In all cases less shives were detected in the paper sheets. Losses of around 14% were measured. The variation between the treatments was relatively high, due to the heterogeneity of the jute substrate. Further research is needed to solve the problem of sampling taking. Secondly, variation in the growth of the fungi in the various Erlenmeyer's need to be controlled by using larger volumes, smaller pieces of jute or even fragmentation of the jute substrate.

Conclusion

It has been shown that both enzymes and specific fungal strains may be of help in improving the brightness and saving energy when making paper from green jute chips. Further detailed studies are essential to establish a sound recipe for this treatment.

3.2 *The effects of enzymatic pre-treatment on hydrogen peroxide bleaching of Extruder Refiner Pulp (XRP)*

3.2.1 *Experimental*

3.2.1.1 *Pulping*

Green jute was treated in an extruder and refiner (XRP) as described in the quarter report 2002-1 (R020306d Table 3). The pulp was processed in the extruder without any chemicals, with a specific energy of 494 kWh/ton. The atmospheric refiner treatment was performed with a plate distance of 0.15 mm and a specific energy of 528 kWh/ton. So the total amount of energy used to prepare this XRP was about 1000 kWh/ton.

3.2.1.2 *Hydrogen peroxide bleaching*

The extruded and refined pulp was bleached at different NaOH and H₂O₂ concentrations to find the optimal concentration of chemicals. At the optimum concentration the peroxide bleaching was combined with enzymatic treatments with xylanase and laccase.

The extruded and refined pulp was pre-treated with 0.6% DTPA at 60 °C at a consistency of 1% during 1 hour. After this pre-treatment the pulp was drained and pressed to a consistency of about 50 %

Peroxide bleaching was performed in plastic bags during 90 minutes at a temperature of 70 °C and a consistency of 20%. The addition of 0.2% MgSO₄·7H₂O and 7% Sodium silicate of 39° Bé (S.G. 1.37 kg/l) was the same in each bleaching experiment. The total alkaline concentration was 3 to 5% and hydrogen peroxide was added in concentrations of 3.5 to 6%. Sodium silicate and magnesium sulphate concentrations were high to be sure that maximum brightness is achieved under the chosen hydrogen peroxide and alkali conditions, further optimisation of these chemicals has to be done in an industrial situation.

The enzymatic treated pulps were bleached at total alkaline concentrations of 4 and 5% and a corresponding hydrogen peroxide concentration of 3.5 and 5%. After bleaching the pH of the bleach liquor was measured and a qualitative test on hydrogen peroxide was carried out. The pulp was acidified to a pH of 5 to 5.5.

3.2.1.3 *Enzymatic treatment*

Enzymatic treatment was carried out between the DTPA pre-treatment and the hydrogen peroxide bleaching.

Green Jute XRP mechanical pulp with a consistency of 50,3 % was diluted to a consistency of 1,7 % and disintegrated in a phosphate buffer of 25 mM and pH 7.0. The pulp was heated with electric cooking plates, under constantly stirring at 500 rev.min⁻¹, till 50°C. As soon as this temperature was reached, the enzymes were added. The temperature and stirring speed were kept constant. The enzymes Pulpzyme HC

(xylanase) and Novozyme 51003 (laccase) were used in concentrations of respectively 50 and 100 Units/gram dry weight of jute. Control pulps were heated and stirred without enzymes. The reaction time for xylanase was 120 min and for laccase 240 min. The recovery of dry weight after xylanase treatment was 90,2 %, after laccase treatment 91,9 %, and for the control 95,2%

After enzymatic treatment the pulp was drained and pressed to a consistency of 45% before bleaching chemicals were added.

3.2.1.4 Handsheet properties

After bleaching, the pulp was disintegrated and handsheets of 160 g/m² were made on a Rapid-Köthe sheet former. The production, conditioning, brightness measurements and strength properties measurements of these handsheets were all carried out according to ISO standards.

3.2.2 *Results*

3.2.2.1 Brightness

The ISO brightness of the bleached XRP pulp increases with hydrogen peroxide and alkalinity. Mechanical pulps of wood normally require a total alkaline concentration that is lower than the hydrogen peroxide concentration. In bleaching green jute a higher total alkaline is needed, so jute pulp must contain a higher content in acid groups than wood. A concentration of 4.5 to 5% of hydrogen peroxide and a total alkalinity of 5% leads to an optimum brightness of 70% ISO (Figure 3.1). Higher brightness can be achieved if bleaching is carried out at 30% consistency. Also higher hydrogen peroxide concentrations can raise the brightness another few points (

Figure 3.1), but that would lead to high chemical costs, which would make the total pulp production process less feasible. It must be possible to reach a brightness of 75 ISO % on an industrial scale. The pH after bleaching varied between 8 and 9 and for the highest brightness values between 8 and 8.5. Depending on the used conditions rest peroxide was found.

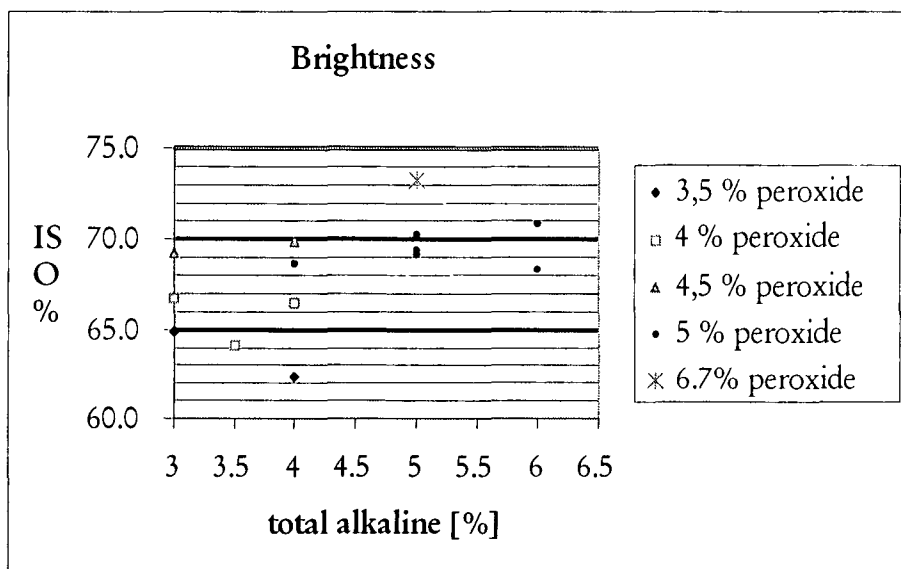

Figure 3.1: Brightness of peroxide bleached XRP pulp

The results of the enzymatic treatments are presented in Figure 3.2. Laccase treatment before hydrogen peroxide bleaching raised the brightness with 2 to 3 points. Depending on the alkali and peroxide concentrations, this corresponds with a 0.5% to 1% lower hydrogen peroxide addition. The enzymatic treatment did not raise the brightness of the unbleached pulp (31 ISO %)

Xylanase treatment between DTPA treatment and bleaching did not result in a higher brightness than the reference (procedure the same but without enzymes). It results in a higher brightness than the untreated pulps, but the same increment can be gained if the pulp undergoes the enzyme treatment without actually dosing the enzymes (see no enzymes in Figure 2). Obviously, this treatment partly cleans the pulp mass.

The DTPA treatment and washing step resulted in a loss of about 10% of the dry matter. The enzymatic treatment results in another 10% loss and in the case of the reference pulp 5%.

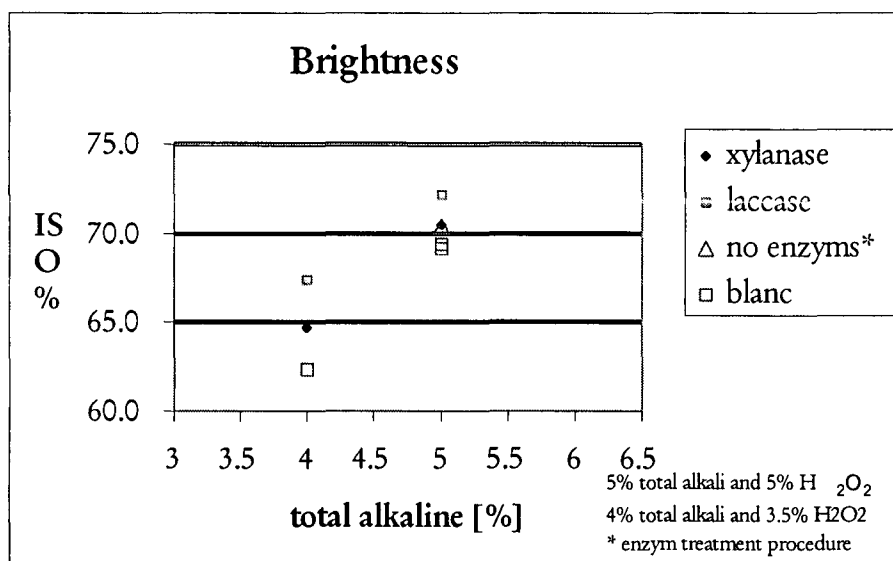

Figure 3.2: Increase of brightness due to enzyme treatments

3.2.2.2 Strength properties

The strength properties of the enzyme treated, and with 5% peroxide and 5% alkali bleached, XRP pulps were measured. They were compared with a reference that was treated in the same way but without actual enzyme application. As can be seen in Table 3.1 the enzyme treatment had no significant effect on the strength properties.

The beating degree values are an estimation because it was measured after disintegration of the handsheets after testing. This beating degree was around 14 °SR, which is very low compared to the 27 °SR before these treatments. This means that a lot of fine particles are washed out by the DTPA pre-treatment and bleaching procedures. Bleaching of the pulp results in an increase of the breaking length from 0.9 km to 1.9 km, but the strength properties are still low compared to the results of Xu who found higher strength properties in relation to the density [1]. The question raises if this is due to a different type of green jute or that chemicals in the production of mechanical pulps are a necessity. Beating of this enzyme treated and bleached XRP pulps will raise the strength properties, but a comparable strength- density relation as Xu found will not be reached.

Table 3.1: Strength properties of enzymatic treated and bleached XRP pulps

	Enzyme control	Xylanase 50 u/g	laccase 100u/g
Beating degree (°SR)*	13.5	14	14
Basis weight (g/m ²)	150.8	149.9	152.1
Density (kg/m ³)	424	414	418
Breaking length (km)	1.9	1.7	1.9
T.E.A.-index (Nm/g)	112	99	99
E-modulus (Gpa)	2.22	2.04	2.02
Strain at failure (%)	0.93	0.89	0.9
Burst index (kPam ² /g)	0.68	0.65	0.64
tear index (mNm ² /g)	2.72	3.18	2.62
Short span compression (Nm/g)	1.70	1.51	1.54
*after disintegration of the produce paper during 10000 revolutions			

3.2.3 *Conclusions*

- ❖ With 4.5 to 5% hydrogen peroxide and 5% alkalinity a brightness of 69 à 70 ISO % can be reached. It must be possible to reach a brightness of 75 ISO % on an industrial scale.
- ❖ Bleaching increases the strength properties.
- ❖ Laccase treatment before hydrogen peroxide bleaching raised the brightness with 2 to 3 points. This corresponds with a 0.5% to 1% lower hydrogen peroxide addition.
- ❖ Applying the enzyme procedure without addition of enzymes raises the brightness too. Obviously, the procedure partly cleans the pulp mass. It is essential to consider proper control experiments when applying enzyme technology and draw conclusions.
- ❖ Enzymatic treatment can be applied without loss of strength properties.

3.3 *The effects of enzymatic pre-treatment on hydrogen peroxide post-bleaching of Alkaline Peroxide Extruder Pulp (APXP)*

3.3.1 *Experimental*

3.3.1.1 Pulping

In the second quarter report bleaching experiments are described with green jute pulp. Green jute was treated in an extruder with bleaching chemicals as described in the quarter report 2002-1 (run 4 Table 2). The amount of energy used to prepare this still very course APXP pulp was about 180 kWh/ton. After the extrusion step the pulp was held for 1.5 hour in a warm water bath to complete the bleaching step.

3.3.1.2 Post bleaching with Hydrogen Peroxide

The APXP pulp was pre-treated with 0.6% DTPA during 1 hour at a temperature of 70 °C. After this pre-treatment the pulp was drained and pressed to a consistency of about 40%

Peroxide bleaching was performed in plastic bags during 90 minutes at a temperature of 70 °C and a consistency of 20%. The addition of 0.2% $\text{MgSO}_4 \cdot 7\text{H}_2\text{O}$ and 7% Sodium silicate of 39° Bé (S.G. 1.37 kg/l) was the same in each bleaching experiment. The peroxide concentration was varied between 1 and 4% and the total alkali concentration was varied between 0.5 and 2%. Sodium silicate and magnesium sulphate concentrations were high to be sure that maximum brightness is achieved under the chosen hydrogen peroxide and alkali conditions, optimisation of these chemicals has to be done in an industrial situation.

The enzymatic treated pulps were bleached at a total alkaline and hydrogen peroxide concentrations of 1%. After bleaching the pH of the bleach liquor was measured and a qualitative test on hydrogen peroxide was carried out. The pulp was acidified to a pH of 5 to 5.5.

3.3.1.3 Enzymatic treatment

Enzymatic treatment was carried out between the DTPA pre-treatment and the hydrogen peroxide bleaching.

Green Jute APXP pulp was diluted to 1.7% and disintegrated in a phosphate buffer of 25 mM and pH 7.0. Pulp was heated with electric cooking plates, under constantly stirring, till 50°C. As soon as this temperature was reached, the enzymes were added. The temperature and stirring speed were kept constant. Xylanase (Pulpzyme HC) was used in concentrations of 1, 5, 25 and 50 units/g and laccase (Novozyme 51003) was used at 100 units/g.

After enzymatic treatment the pulp was drained and pressed to a consistency of about 50% before bleaching chemicals were added.

3.3.1.4 Handsheet properties

After bleaching the pulp was disintegrated and handsheets of 160 g/m² were made on a Rapid-Köthe sheet former. The production, conditioning, brightness measurements and strength property measurements of these handsheets were all carried out according to ISO standards.

3.3.2 Results

The brightness that was reached with bleaching was about 72 ISO % (

Figure 3). This is about the same level that was reached with bleaching the XRP pulp (table 1 and 2). With 2.5% peroxide the brightness is still increasing with raising alkali concentration. So probably a small improvement of the brightness is still possible, but costs will be high. The pH after bleaching varied between 9.3 and 10.2. In all cases there was a fair amount of rest peroxide indicated. The loss due to the DTPA treatment was about 4% of the dry matter.

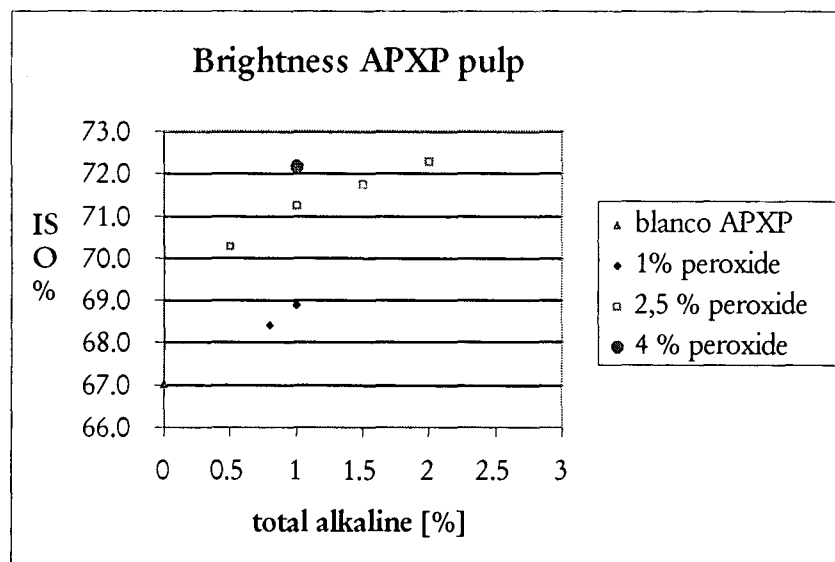

Figure 3.3: Brightness of bleached APXP pulp

The enzymatic treatment was applied in combination with a bleaching step of 1% hydrogen peroxide and 1% total alkali. The results show that a xylanase treatment has a positive effect on the brightness. The effect of the treatment is the same as 1 to 2 % of extra hydrogen peroxide.

All xylanase treatments show this level of improvement (

Figure 3.4).

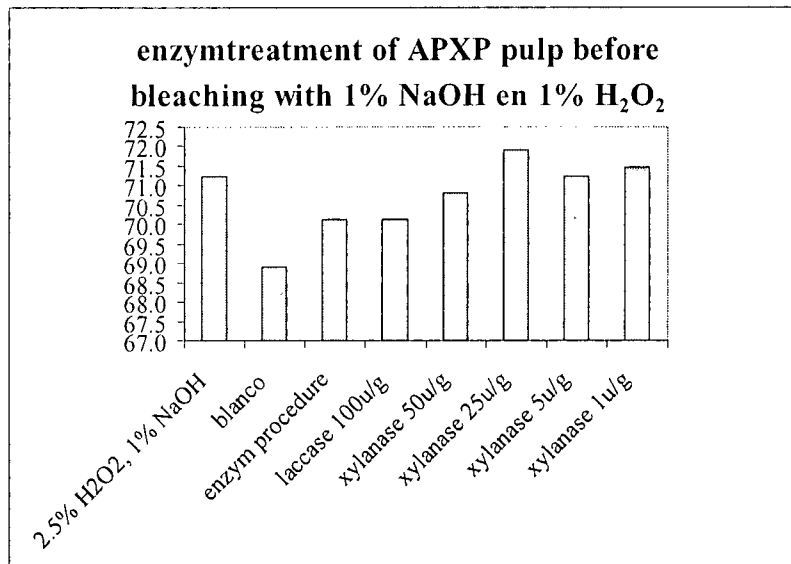

Figure 3.4: Brightness increase of APXP pulp due to enzyme treatment

The treatments Have not been repeated yet, but the differences in the xylanase treated samples show the variation in the bleaching step and the brightness measurements. The brightness measurements itself have a mean standard deviation of 0.33 ISO%. A xylanase treatment with only 1 unit/g already appears to be sufficient to reach this increase in brightness, higher xylanase concentrations do not raise the brightness any further.

In contrast with the bleaching of XRP pulp the laccase treatment did not show any improvement. It has the same brightness level as the pulp treated by the enzyme procedure, but without the actual dosing of the enzymes.

As mentioned before this treatment raises the brightness due to washing or cleaning effects.

However, after thickening of the enzymatic treated pulp and reference pulp, dark spots were still visible in the pulp pad (Figure 3.5).

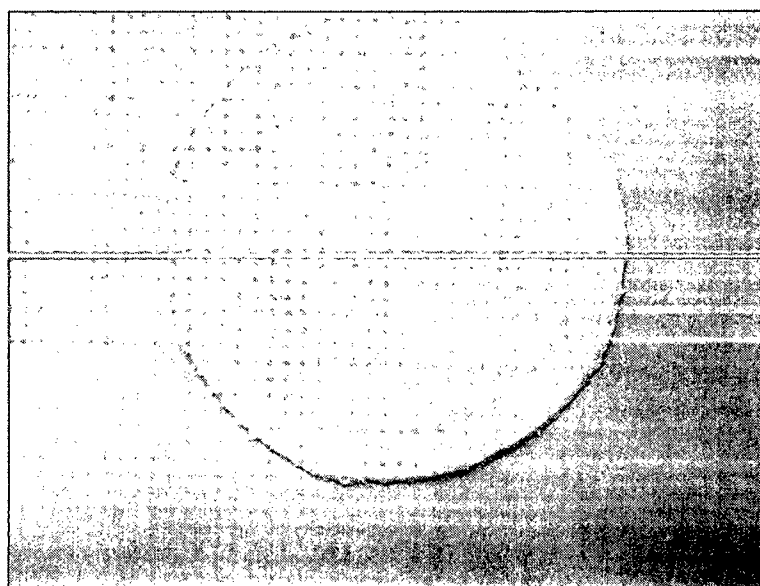

Figure 3.5: Pulp pad after enzymatic treatment

3.3.2.1 Strength properties

The breaking length of the unbeaten APXP pulp is about the same as from the XRP pulp at the same beating degree level. The low level of beating degree of the unbeaten pulps proves that a lot of the fines, necessary for strength, are washed out.

A xylanase treatment did not raise the breaking significantly at unchanged beating degree (Table 3.2). After testing, these hand sheets were disintegrated and beaten in a PFI mill. This beating action raised the breaking length strongly and resulted in a high density of the paper sheet. The differences between hand sheets of the beaten pulps are not conclusive due to a strongly different basis weight in the hand sheets beaten reference.

Table 3.2: Strength properties of enzyme treated and post bleached APXP pulps

	Blanc* beaten	xylanase 1 u/g beaten	blanc* unbeaten	xylanase 1u/g unbeaten
Beating degree (°SR)*	32	27	12	12
Basis weight (g/m ²)	158.8	171.1	170.9	164.5
Density (kg/m ³)	728	715		
Breaking length (km)	4.8	4.3	1.8	2.1
T.E.A.-index (Nm/g)	972	814	99	126
E-modulus (Gpa)	6.30	6.09		
Strain at failure (%)	2.4	2.6	0.9	0.9
Short span compression (Nm/g)	2.92	2.74		
* blanc = bleaching with 1% H ₂ O ₂ and 1% total alkalinity without the enzyme procedure				

The tensile strength of the hand sheets of the beaten pulp is close to those of the experiments done by Xu (1). But in our experiments the density is much higher. Xu is thus making a thicker paper with the same strength, this means that fibre bonds in the experiments of Xu must be much stronger since there is less fibre to fibre contact in his hand sheets.

3.3.3 Conclusions

- ❖ Post bleaching of the APXP pulp leads to the same brightness level as the XRP pulp after bleaching.
- ❖ The enzyme treatment procedure without the actual dosing of enzymes raises the brightness by 1 ISO%.
- ❖ A xylanase treatment can replace 1 to 2% of hydrogen peroxide
- ❖ A low concentration of 1 unit of xylanase/g is sufficient.

- ❖ Laccase does not improve the brightness of the APXP pulp.
- ❖ The washing treatments create loss of fines, resulting in low beating degree and low strength properties.

3.3.4 *Recommendation*

To prevent loss of fines, treatments necessary to clean the fibres should be performed as early as possible in the process when the jute is still coarse.

Literatuur

1. Xu E.C., *APMP pulps from nonwood fiber Part 2: Jute*. Tappi Journal, 2001. **84**(11).

3.4 The effects of microbiological pre-treatment on simulated refiner mechanical pulp of green jute

3.4.1 Material and methods

Dry green jute was chopped in a wood chipper and subsequently chopped with a guillotine type of chopper adjusted to 6.25 mm. Chips were put in 3-l Erlenmeyers in portions of 220 gram and sterilised (20 min at 121°C) before inoculation.

Three strains of micro-organisms, *P. drosoporum* (2x) and *F. lignosus*, were grown on potato dextrose agar (PDA) for 5 days at 37°C. Subsequently, pieces of agar were transferred to liquid medium (0.3% malt extract, 0.3 % yeast extract and 1% glucose), and the micro-organisms were grown for another 5 days to obtain enough material.

The fungi layers were dispersed into 25 ml of the same medium and carefully resuspended in a Waring blender. Cells were centrifuged for 5 min at 3000 rpm and the wet weight was determined. Pellet was resuspended in 10 ml of growing medium. Dry weight was determined on a Whatman cellulose nitrate membrane filter. On the base of the dry weight, a volume with in total 30 mg of micro-organisms was added to 220 g of jute chips (+/- 193 g dry weight). The dosage of the micro-organisms was thus 30 mg DW per 220 g of dry jute chips = 4.45 gram per ton.

Subsequently, the inoculated chips were carefully wet with medium up to a moisture content of 66% (medium: 100 mg/L KH_2PO_4 , 200 mg/L NaH_2PO_4 , 450 mg/L MgSO_4 , 100 $\mu\text{g/L}$ FeSO_4 , 20 $\mu\text{g/L}$ CuSO_4 , 10 $\mu\text{g/L}$ ZnSO_4 , 10 $\mu\text{g/L}$ MnSO_4 , 100 $\mu\text{g/L}$ CaCl_2 , 10 μg thiamine-HCl en 20 g/L glucose).

The Erlenmeyers were incubated at 37°C.

After the incubation period the Erlenmeyers with the chips were sterilised for legislation reasons. So pulp and paper properties of treated jute were actually determined on two-times sterilised material.

After the microbiological treatment the jute was soaked in water at a dry matter content of 5%. Soaking was done during 10 minutes with stirring by hand every 5 minutes. The surplus of water was drained and the soaking started again with fresh water during 20 minutes and stirring by hand every 5 minutes.

Four samples of the treated and washed jute were beaten in a PFI mill during 500 revolutions with a gap of 2 mm and 500 revolutions with a gap of 1 mm. After these two stages of milling the jute was beaten with a gap of 0 mm and the standard pressure of 66.6 N/cm² during several thousands of revolutions. The number of revolutions depended on the reached beating degree. In this way a beating curve of the pulp was made. The beating procedure is a lab scale simulation of the refiner mechanical pulping process (RMP). The energy needed in the stage with a zero gap was measured. The beating degree was limited to 70 °SR because higher beating degrees would have no practical meaning.

After disintegration during 10.000 revolutions in a standard disintegrator, the beating degree (°SR) of the beaten pulp was measured and hand sheets were made with a Rapid-

Köthen sheet former. The hand sheets were tested for grammage, thickness, bulk or density, breaking length, strain, burst strength, short span compression strength (SCT) and brightness at 50% relative humidity (RH) and 23 °C. Beating, hand sheets making and testing were all performed according to the ISO-standards.

3.4.2 Results

The used milling procedure made it possible to create a simulated RMP pulp in a PFI mill. The number of revolutions was higher than for beating a chemical pulp and the power during each revolution was also much higher. The measured energy cannot be translated to the amount of energy that is needed for the production of a RMP pulp in a production scale refiner, but it can be used in the comparison of energy demand of microbiological treated green jute with untreated green jute.

The chopped jute was inhomogeneous with respect to the dimensions, pieces of 4 cm length and pieces to 1.5 cm thickness could be found as well as very small particles of a few millimetres. This variation in particle size, together with variations in the growth of the fungi creates large differences between the duplicates. Therefore the pulps that have been treated with different types of fungi are sometimes presented as one group in the graphs underneath.

The different fungi treatments resulted in paper sheets with visually less shives, but they also caused weight losses after washing of around 14%.

The treatments with the fungi result in a much faster development of the beating degree (Figure 3.6). In general 2/3 of the number of revolutions is sufficient to reach the same beating degree. The savings in energy are in the same order of magnitude (Figure 3.7).

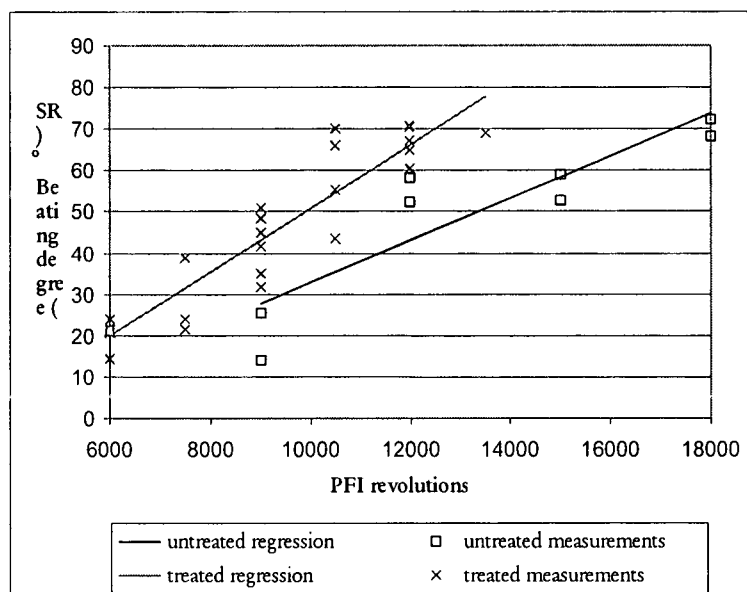

Figure 3.6: Beating degree versus PFI revolutions

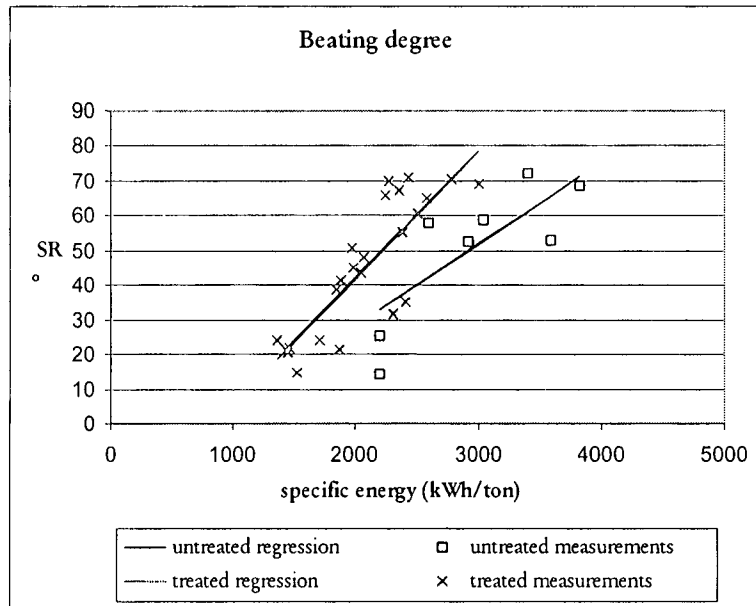

Figure 3.7: Beating degree versus specific energy

The strength properties like breaking length, SCT and E-modulus of the produced hand sheets all show the same faster development for the treated green jute (

Figure 3.8 and

Figure 3.9).

If the strength properties are plotted against the beating degrees it appears that the jute treated with *P. dmysosporium* is stronger at the same beating degree than the untreated and with *F.lignosus* treated jute (Figure 3.10). The *F.lignosus* treated jute gives an almost identical relation between breaking length and beating degree as the untreated jute does. So treatment with *F.lignosus* results in a lower specific energy but not in differences in beating degree and breaking length. Treatment with *P. dmysosporium* results in a lower specific energy and a higher strength at the same beating degree or the same strength at a lower beating degree. Which means that the machine can either make a better quality paper or can run faster.

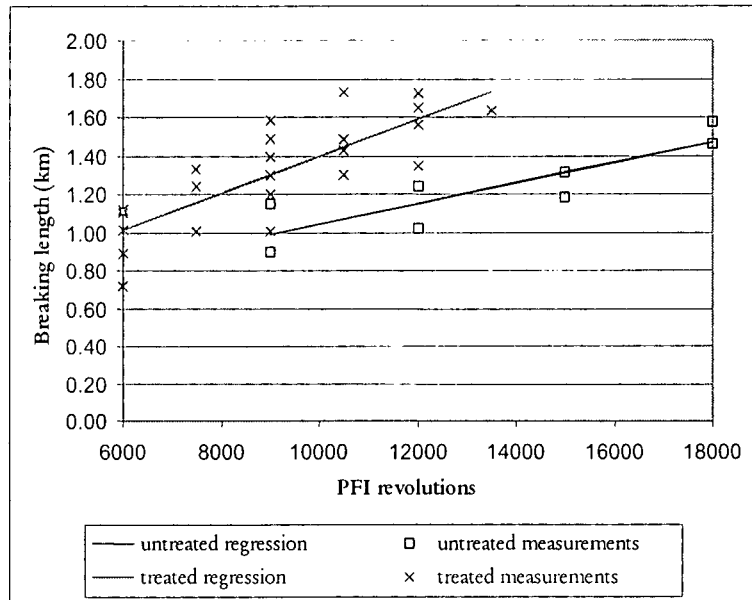

Figure 3.8: Breaking length versus PFI revolutions

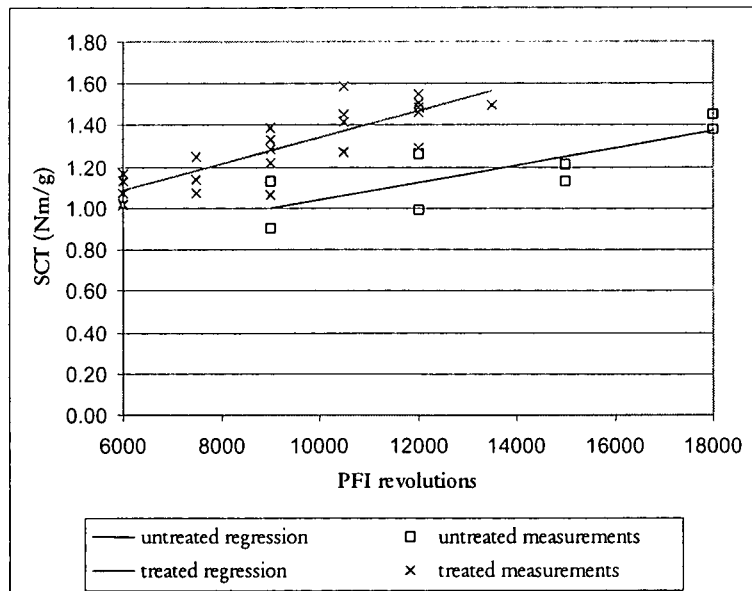

Figure 3.9: Short Span Compression Test versus PFI revolutions

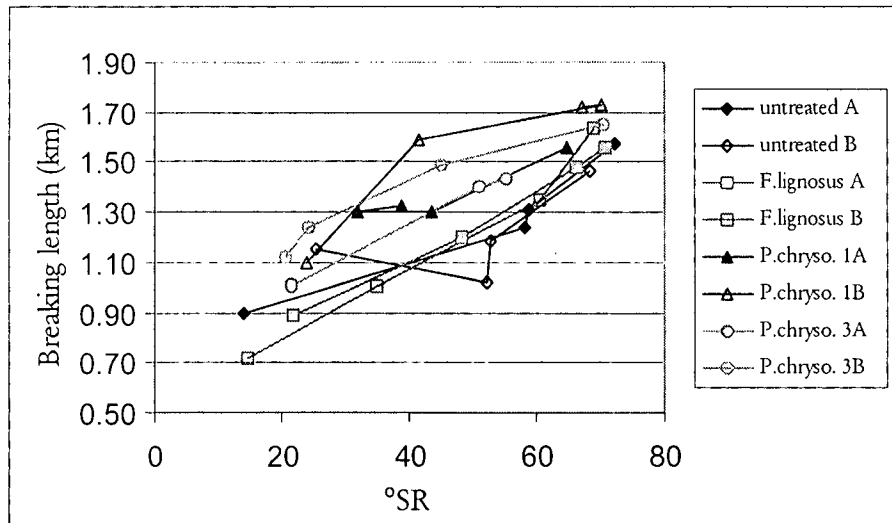

Figure 3.10: Breaking length versus beating degree

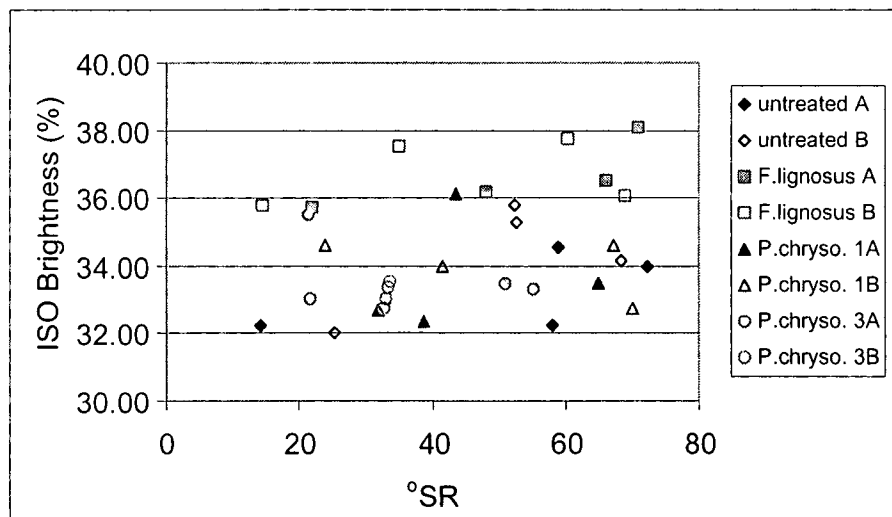

Figure 3.11: Iso brightness in relation to beating degree

The brightness of the different pulps strongly fluctuates between 32 en 38%, but all the *F.lignosus* treated pulps are between 36 and 38%, which is in average 3% higher than the other pulps. So instead of a higher strength after *P. chrysosporium* treatment, *F.lignosus* creates a higher brightness in non-bleached pulps.

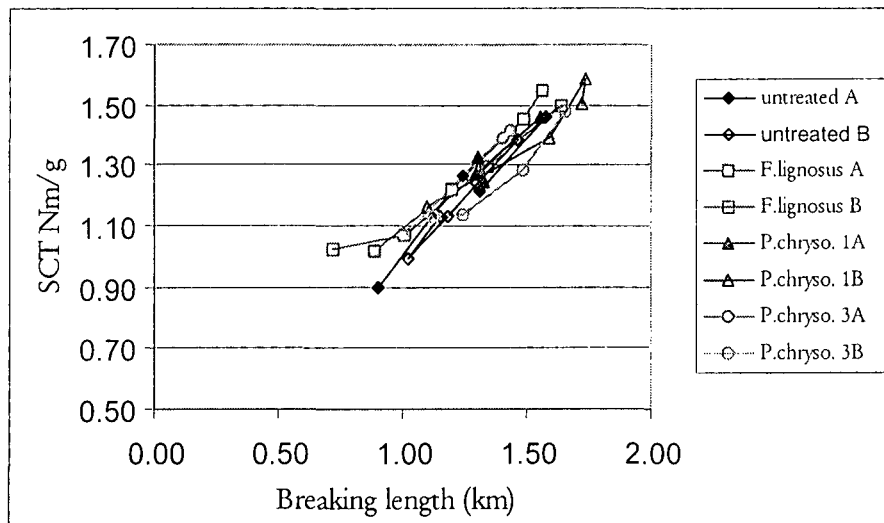

Figure 3.12: SCT versus breaking length

The correlation between the SCT and breaking length is good. The differences between the different treatments are small. This shows that the variations in measured values are mainly caused by the treatments and the inhomogeneous material and not by the hand sheet making and testing procedures.

3.4.3 Conclusions

- ❖ Biomechanical-pulping results in energy savings of 25 to 30%, or an improvement of strength properties at equal specific energy.
- ❖ The loss of weight after microbiological pre-treatment (=washing) is around 14%. It depends on the costs of green jute whether this is of any economic relevance.
- ❖ The use of *F.lignosus* results in a brightness improvement of the unbleached pulps of 3 ISO %.
- ❖ Treatment with *P. dnysosporium* leads to higher strength properties than with *F.lignosus* at equal beating degree.
- ❖ Microbiological treatment results in less shives in the paper sheets.

3.4.4 Recommendations

To be able to draw sound conclusions from the small-scale experiments it is essential to minimise the variability of the jute chips-substrate, being responsible for the relatively high variance. Therefore next experiments will be carried out on further chopped pieces and maybe even fractionated chips, improving the homogeneity of the jute substrate samples.

A second point of concern is the growth of the fungi in the different Erlenmeyer flasks. Time/concentration experiments are needed to exclude the influence of differences in the growth and therefore the effects.

Appendix 1

	kWh/ton	PFI revolutions	drainability (%)	SR	grammage (g/m ²)	thickness (µm)	density (kg/m ³)	breaking length (km)	tensile index (Nm/g)	E-modulus (Gpa)	strain (%)	SC1 (Nm/g)	ISO brightness (%)
untreated A	2190	9000	14	80.7	416	241	0.90	8.8	0.40	0.61	0.90	32.3	
untreated A	2595	12000	58	82.9	286	350	1.24	12.2	0.81	0.60	1.27	32.3	
untreated A	3048	15000	59	84.8	280	357	1.31	12.9	0.85	0.66	1.22	34.6	
untreated A	3407	18000	72	86.1	264	379	1.58	15.5	1.05	0.68	1.46	34.0	
untreated B	2200	9000	25	83.9	327	306	1.15	11.3	0.65	0.70	1.13	32.0	
untreated B	2921	12000	52	86.2	307	326	1.02	10.0	0.64	0.62	0.99	35.8	
untreated B	3593	15000	53	83.1	284	352	1.19	11.6	0.78	0.62	1.13	35.3	
untreated B	3831	18000	68	85.7	266	376	1.46	14.3	0.97	0.67	1.38	34.1	
F.lignosus A	1457	6000	22	83.1	347	290	0.89	8.7	0.55	0.56	1.02	35.7	
F.lignosus A	2074	9000	48	86.9	291	344	1.20	11.8	0.78	0.68	1.22	36.2	
F.lignosus A	2240	10500	66	84.2	264	380	1.48	14.6	0.99	0.72	1.45	36.5	
F.lignosus A	2426	12000	71	81.6	259	386	1.56	15.3	0.99	0.74	1.55	38.1	
F.lignosusB	1521	6000	15	83.2	373	269	0.72	7.1	0.45	0.50	1.02	35.8	
F.lignosusB	2405	9000	35	85.2	309	325	1.01	9.9	0.67	0.62	1.07	37.5	
F.lignosusB	2510	12000	60	84.5	265	378	1.34	13.2	0.93	0.70	1.29	37.8	
F.lignosusB	3007	13500	69	83.1	262	382	1.64	16.0	1.03	0.78	1.50	36.1	
Chrysosporium 1A	1841	7500	39	82.2	300	334	1.33	13.0	0.80	0.71	1.25	32.3	
Chrysosporium 1A	2304	9000	32	82.6	292	343	1.30	12.8	0.80	0.68	1.33	32.7	
Chrysosporium 1A	2039	10500	44	90.7	272	367	1.30	12.7	1.01	0.64	1.27	36.1	
Chrysosporium 1A	2585	12000	65	74.2	263	381	1.56	15.3	0.91	0.70	1.46	33.5	
Chrysosporium 1B	1355	6000	24	82.0	315	319	1.10	10.8	0.69	0.67	1.16	34.6	
Chrysosporium 1B	1877	9000	42	83.5	267	375	1.59	15.6	1.03	0.77	1.39	34.0	
Chrysosporium 1B	2264	10500	70	86.5	253	395	1.73	17.0	1.18	0.74	1.58	32.8	
Chrysosporium 1B	2358	12000	67	83.3	251	398	1.72	16.9	1.14	0.77	1.51	34.6	
Chrysosporium 3A	1437	6000	22	85.3	319	314	1.01	9.9	0.59	0.68	1.07	33.0	
Chrysosporium 3A	1868	7500	21	83.0	305	329	1.00	9.8	0.69	0.58	1.07	35.5	

Chryso sporium 3A	1975	9000	51	85.2	271	369	1.40	13.7	0.95	0.72	1.39	33.5
Chryso sporium 3A	2385	10500	55	86.1	268	373	1.43	14.0	0.97	0.70	1.42	33.3
Chryso sporium 3B	1451	6000	21	84.6	331	302	1.12	11.0	0.62	0.73	1.13	33.0
Chryso sporium 3B	1710	7500	24	84.3	316	317	1.24	12.2	0.75	0.77	1.14	33.5
Chryso sporium 3B	1980	9000	45	82.4	274	366	1.48	14.6	0.91	0.76	1.29	33.4
Chryso sporium 3B	2785	12000	70	83.5	256	391	1.65	16.2	1.08	0.79	1.48	32.8

Appendix 2

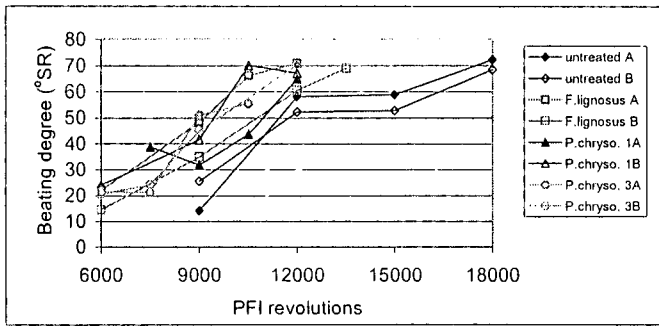

Figure A1: Beating degree versus PFI revolutions

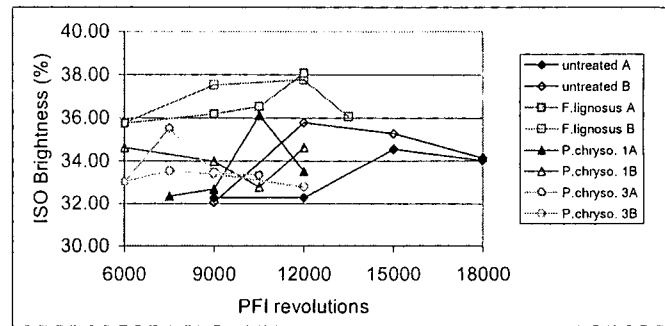

Figure A2: ISO Brightness versus PFI revolutions

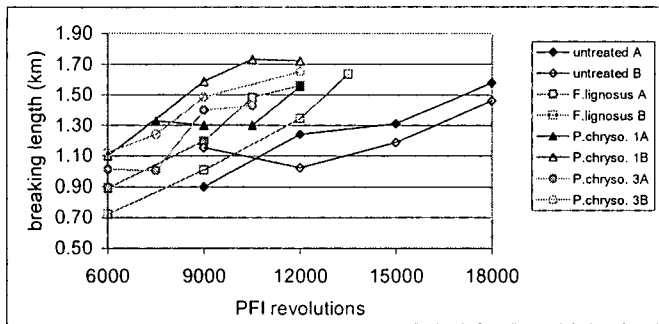

Figure A3: Breaking length versus PFI revolutions

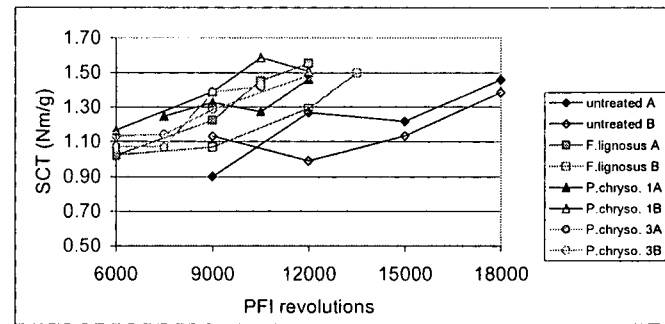

Figure A4: SCT versus PFI revolutions

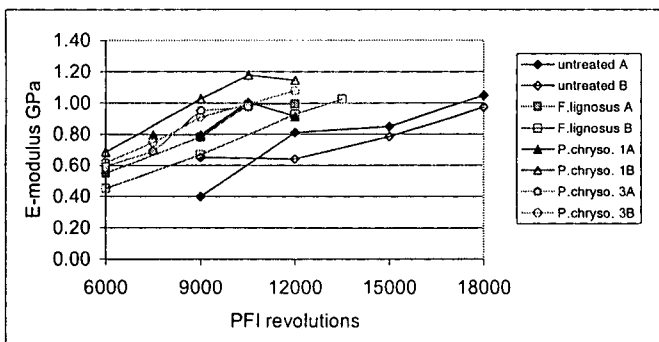

Figure A5: E-modulus versus PFI revolutions

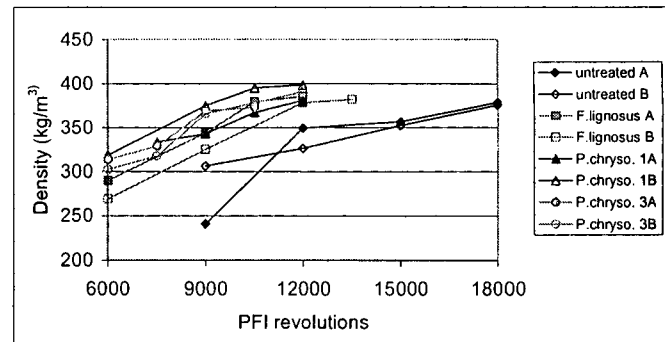

Figure A6: Density versus PFI revolutions

Appendix 3

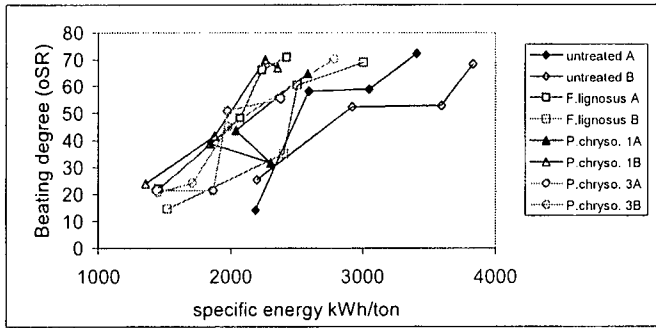

Figure A7: Beating degree versus specific energy

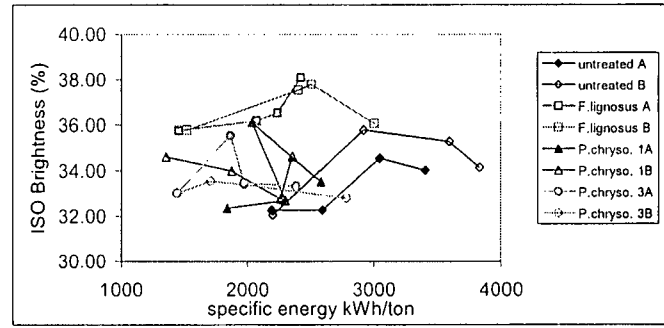

Figure A8: ISO Brightness versus specific energy

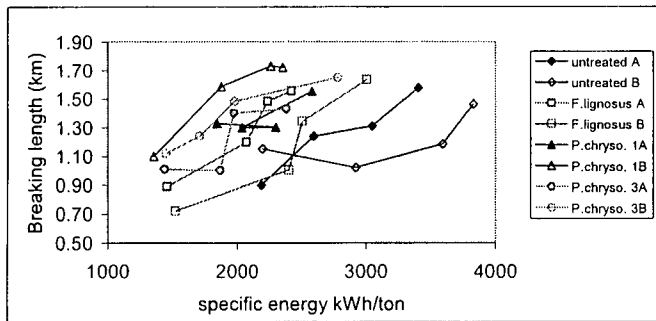

Figure A9: Breaking length versus specific energy

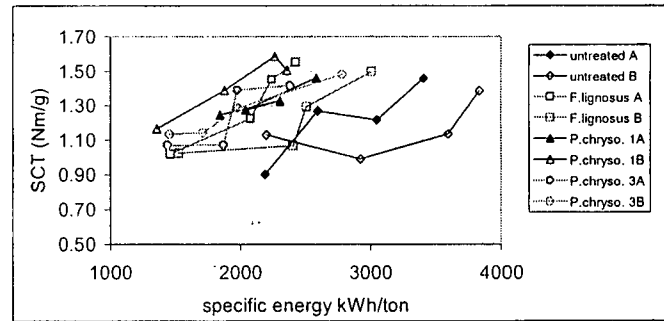

Figure A10: SCT versus specific energy

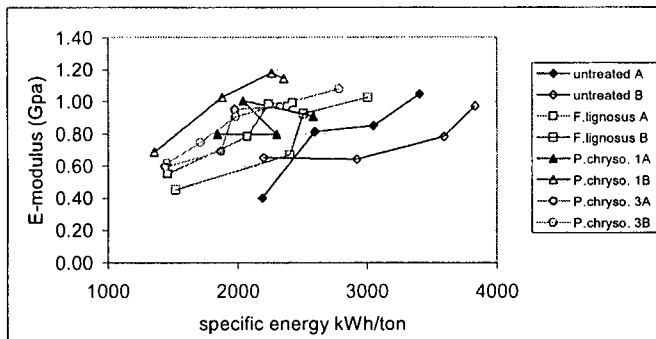

Figure A11: E-modulus versus specific energy

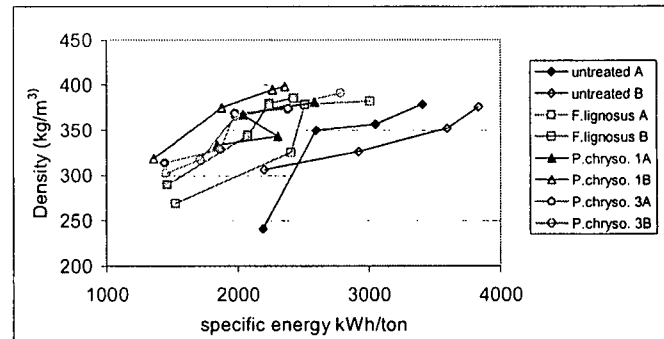
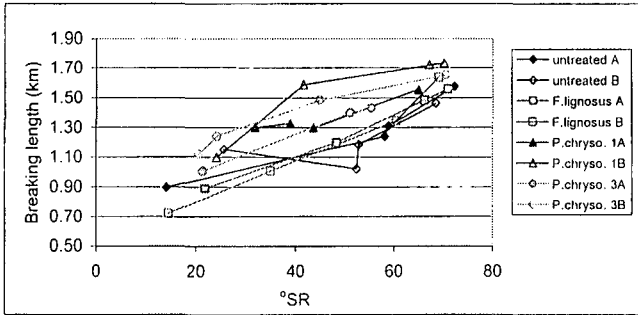
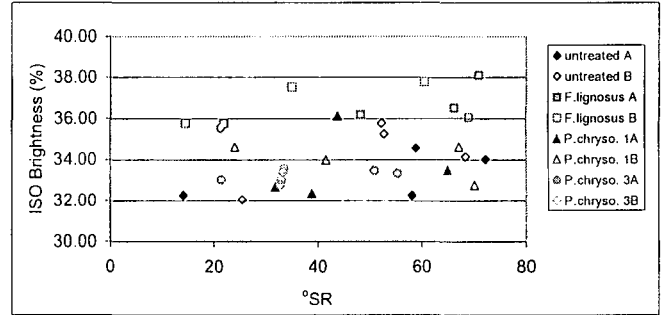

Figure A12: Density versus specific energy



A13: Breaking length versus beating degree



A14: ISO brightness versus beating degree

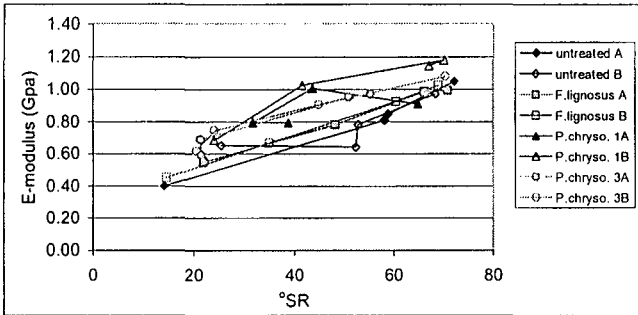

A15: E-modulus versus beating degree

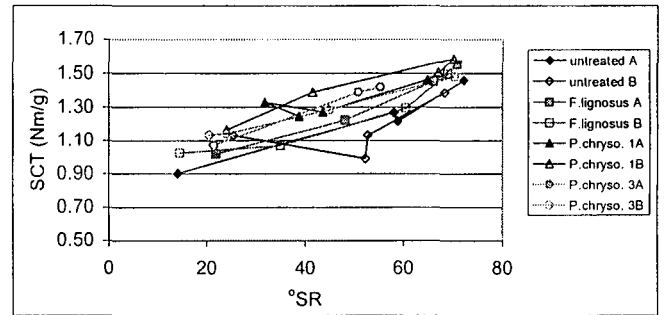

A16: SCT versus beating degree

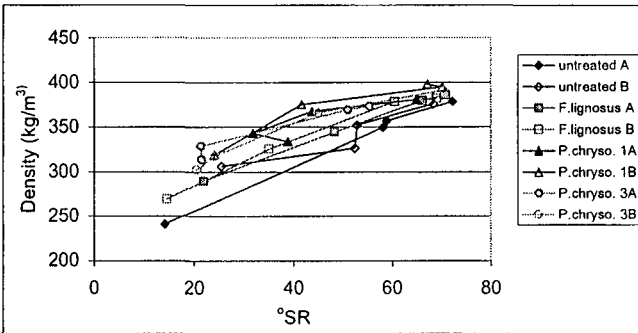

A17: Density versus beating degree

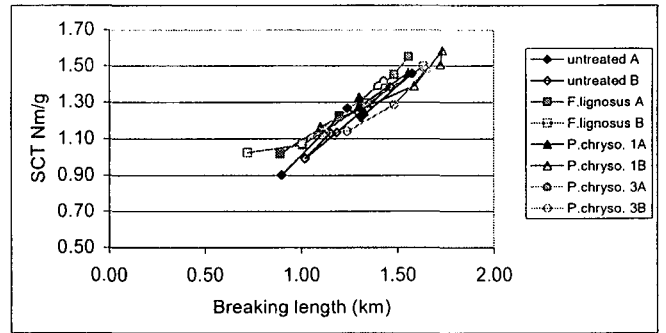

A18: SCT versus breaking length

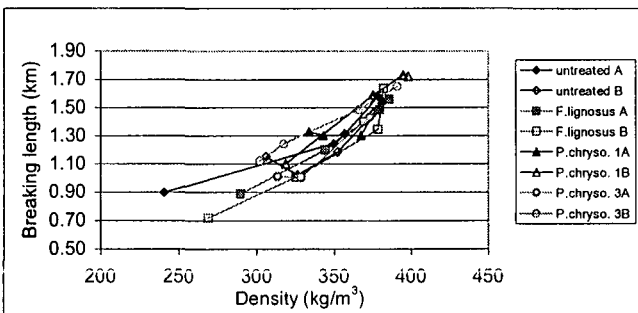

A19: Breaking length versus density

ATO Work Plan for 2003

Tasks/ Activities	2 4 6 8 10 12	Work details	Expected output
Optimization and assessment of effects of pre treatments with micro-organisms on green jute paper qualities	████████	Selection of most promising micro-organism. Quantification of effects on paper properties	Pre treatment recipe
Pilot-plant scale test with selected micro organisms	████████	Comparison of progress/constraints and similarities/differences on scaled-up experiments	Processing data sheet; guidelines for pilot-scale processing
Black liquor analysis	████████	Chemical analysis; COD and BOD	Guidelines for black liquor recovery
Dissemination of results & PCR	████████	Prepare draft Technical Manuals and a draft Project Completion Report (PCR)	Technical Manual and PCR

4 Third-year report

4.1 Management Summary

This report further describes pre-treatment laboratory studies done with the selected *Formis lignosus* on green jute chips as initially documented in progress report 2. The first study is a repetition of the pre-treatment of a simulated RMP pulp, produced in a PFI mill. The results confirm the conclusions of the previous experiments: The pre-treatment with *F.lignosus* gives an energy saving of about 10 to 20 % and a small increase in brightness of 1 to 2 ISO%.

Subsequent studies towards optimum incubation times showed that a minimum period of 12-14 days was needed for an optimal effect. In the various laboratory-scale experiments fungal growth differed. However, within the range of 10-14 days no significant differences in loss were observed. In some experiments 10-day incubations showed lower effects on energy savings, so incubation periods of 12-14 days are advised to be used. The extra weight loss due to the fungal pre-treatment is about 13 %.

In a further study simulated APMP pulps were produced in a PFI mill and pre-treated with the fungus. No statistically significant differences between treated and untreated pulp were found.

Because of the great number of different processing steps that are needed to produce a sheet of paper of jute, the variability is high. The steps include size reduction, pre-treatment, washing, bleaching, beating and making of the paper. Particularly the size reduction is an important step in this procedure. If particles are too large in size, the fungal pre-treatment and the bleaching can be hampered. Besides, bast fibres that are still long, tend to form flocs, which creates extra variation in the ratio of core and bast fibre. It is expected that this last point is not a problem if the process is carried out later on at an industrial scale.

For the small-scale experiments a more homogeneous size distribution and a further reduction to smaller pieces would be beneficial. This was done in extra studies. After the size reduction a pre-refining step was added to the procedure. This step resulted in a more homogeneous material and an easier running of the PFI-mill. In this test a clear difference between treated and untreated pulps evolved. The fungal treatment resulted in savings of energy at the same beating degree or strength properties.

In both simulated APMP studies there were no differences in the brightness of the treated and untreated pulps. Probably, the small brightening effect of *F.lignosus* is overshadowed by the brightening effect of the peroxide treatment. The average brightness after pre-refining was 63.2 ISO %, which is 2.7 % higher than in the first APMP test. Apparently, the extra size reduction in the pre-refining in combination with a higher consistency during bleaching was beneficial.

In the last APMP test the weight loss raised from 16 to 21 % by the fungal pre-treatment. The extra weight loss is low compared with the extra weight loss that fungal treatment caused in the RMP experiments. This means that the main part (60%) of the losses caused by the fungal treatment in RMP process occurs in an APMP process anyway.

Compared to RMP pulps the strength properties and brightness were raised by the alkali peroxide process to a level that makes it possible to use this pulp for the production of newsprint. The brightness was raised from below 40 ISO % to above 60 ISO %.

After the laboratory scale experiments with the PFI mill, APMP tests were carried out on a larger scale with a 12" pressurised refiner system. In these tests an average yield after bleaching, refining and washing of 79% was obtained, which is comparable with the laboratory experiments described and e.g. about 6% lower than for an aspen CTMP pulp. The produced pulps had brightnesses of around 63% and the breaking length was around 4 km. This makes the pulps suitable for use in newsprint. The specific energy needed to produce these pulps was around 500 kWh/ton, which is only 25% of the production of a TMP pulp for newsprint from wood.

The first attempt to execute the fungal pre-treatment in this pilot scale resulted in substantial problems with inhomogeneous fungal growth in the incubation vessels and are therefore not reported in this report. The control tests have been done already (12" pressurised refiner APMP tests, mentioned above). The research on large-scale fungal treatments needs more attention than originally expected and these kind of solid state studies are not part of the actual project and not intended within the allocated budget.

Conclusions:

- APMP pulps from green jute are suitable for the production of newsprint.
- APMP pulp from green jute can be produced with only 25% of the energy needed to produce a TMP pulp for newsprint from wood.
- In the production of lab-scale RMP a pre-treatment with *F.lignosus* results in lower specific energy and a 1 to 2 ISO % higher brightness.
- In the production of lab-scale APMP a pre-treatment with *F.lignosus* results in lower specific energy, but not in a higher brightness.
- Further size reduction by means of a pre-refining step results in better reproducible experiments and probably a more efficient bleaching step.

- The main part of the losses caused by the fungal treatment in a RMP process is also removed by a bleaching step.
- The yield of the APMP from green jute after fungal pre-treatment, bleaching and washing is about 78%.

4.2 *The effects of microbiological pre-treatment on simulated refiner mechanical pulp (RMP) of green jute*

The experiment described in progress report 2 was repeated with a pre-treatment of the selected *F. lignosus*.

4.2.1 *Material and methods*

Green jute stems from Bangladesh were received in pieces with lengths of around 60 cm. The outer bark of the jute was dark brown. These stems are too long to be processed and had to be shortened.

4.2.1.1 *Size reduction*

Dry green jute stems were chopped in a wood chipper and subsequently chopped with a guillotine type of chopper adjusted to 6.25 mm. In previous experiments with simulated RMP in a PFI mill the jute appeared to have too many big parts. Therefore an extra cutting step was carried out in this experiment. The extra cutting was done in a cutting mill with a sieve of 15x15 mm. The dry matter content of the cut fibres was 88.6%

4.2.1.2 *Microbiological treatment*

Chips were divided into portions of 220 grams and carefully wet with medium up to a moisture content of 66% (medium: 100 mg/L KH_2PO_4 , 200 mg/L NaH_2PO_4 , 450 mg/L MgSO_4 , 100 $\mu\text{g/L}$ FeSO_4 , 20 $\mu\text{g/L}$ CuSO_4 , 10 $\mu\text{g/L}$ ZnSO_4 , 10 $\mu\text{g/L}$ MnSO_4 , 100 $\mu\text{g/L}$ CaCl_2 , 10 μg thiamine-HCl en 20 g/L glucose). The wetted chips were put in 3-l Erlenmeyers and sterilised (20 min at 121°C) before inoculation.

F. lignosus, was grown on potato dextrose agar (PDA) for 5 days at 37°C. Subsequently, pieces of agar were transferred to liquid medium (0.3% malt extract, 0.3 % yeast extract and 1% glucose), and the micro-organisms were grown for another 5 days to obtain enough material.

The fungi layers were dispersed into 25 ml of the same medium and carefully resuspended in a Waring blender. Five ml of the medium with cells was centrifuged for 5 min at 3000 rpm and the wet weight was determined. Pellet was resuspended in 5 ml of growing medium. Dry weight was determined on a Whatman cellulose nitrate membrane filter. On the base of the dry weight, a volume with in total 15-mg of micro-organisms was added to 220 g of jute chips (+/- 193 g dry weight). The dosage of the micro-organisms was thus 15 mg DW per 220 g of dry jute chips = 78 gram per ton.

The Erlenmeyers were incubated at 37°C during a period of 13 days.

After the incubation period the Erlenmeyers with the chips were sterilised for legislation reasons. So pulp and paper properties of treated jute were actually determined on two-times sterilised material.

4.2.1.3 Washing and beating

After the microbiological treatment the jute was soaked in water at a dry matter content of 5%. Soaking was done during 10 minutes with stirring by hand every 5 minutes. The surplus of water was drained and the soaking started again with fresh water during 20 minutes and stirring by hand every 5 minutes.

Four samples of the treated and washed jute were beaten in a PFI mill during 500 revolutions with a gap of 2 mm and 500 revolutions with a gap of 1 mm. After these two stages of milling the jute was beaten with a gap of 0 mm and the standard pressure of 66.6 N/cm² during several thousands of revolutions. The number of revolutions depended on the reached beating degree. In this way a beating curve of the pulp was made. The beating procedure is a lab scale simulation of the refiner mechanical pulping process (RMP). The energy needed in the stage with a zero gap was measured. After disintegration during 10.000 revolutions in a standard disintegrator, the beating degree (°SR) of the beaten pulp was measured and handsheets were made with a Rapid-Köthen sheet former. The handsheets were tested for grammage, thickness, bulk or density, breaking length, strain, short span compression strength (SCT) and brightness at 50% relative humidity (RH) and 23 °C. Beating, handsheets making and testing were all performed according to the ISO-standards.

4.2.2 Results

All the measurements are presented in appendix 1 and as graphics in appendix 2. As in the previous experiment the fungal treatment resulted in a faster development of the beating degree (figure 4.1) and the energy needed to reach a specified beating degree is 10 to 20% less than for the untreated jute (figure 4.2).

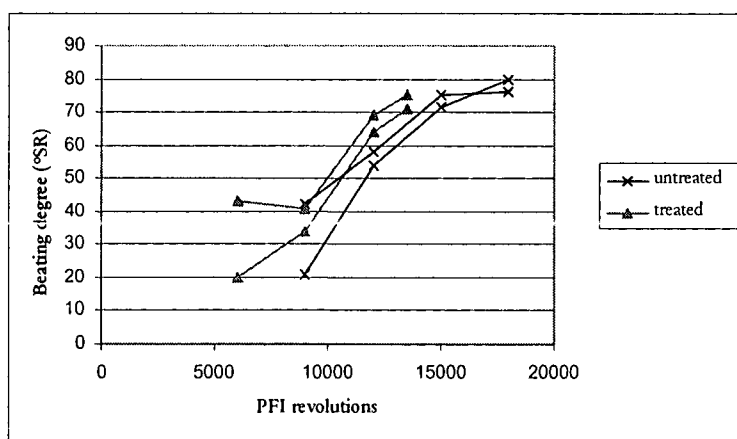

Figure 4.13: Beating degree versus PFI revolutions

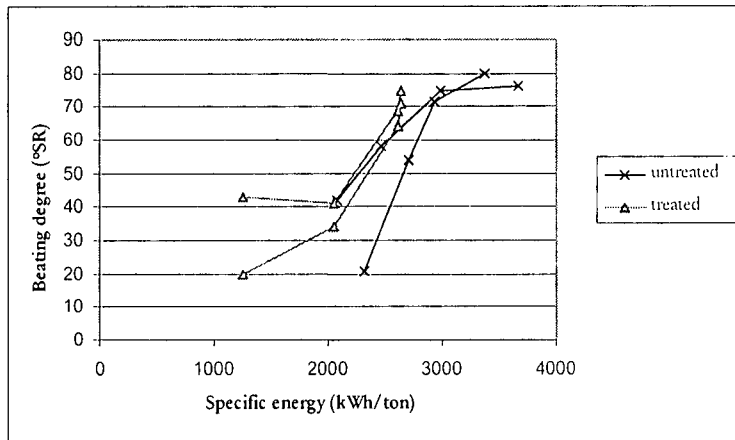

Figure 4.2: Beating degree versus specific energy

To reach specified strength levels, less beating and less energy is needed if the jute is treated with *F. lignosus* (figure 4.3 and Figure 4.4). There is no significant difference between treated and untreated jute in the relation between the breaking length and beating degree.

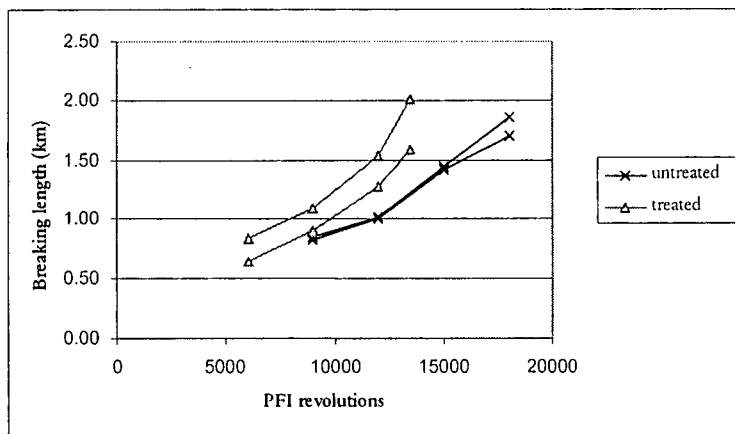

Figure 4.3: Breaking length versus PFI revolutions

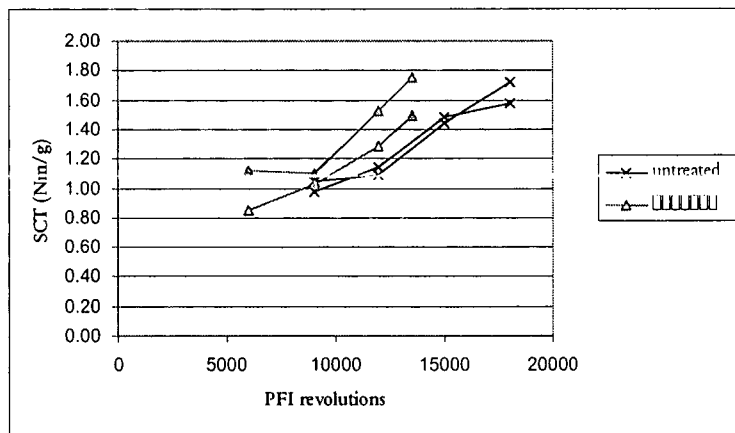

Figure 4.4: Short Span Compression Test versus PFI revolutions

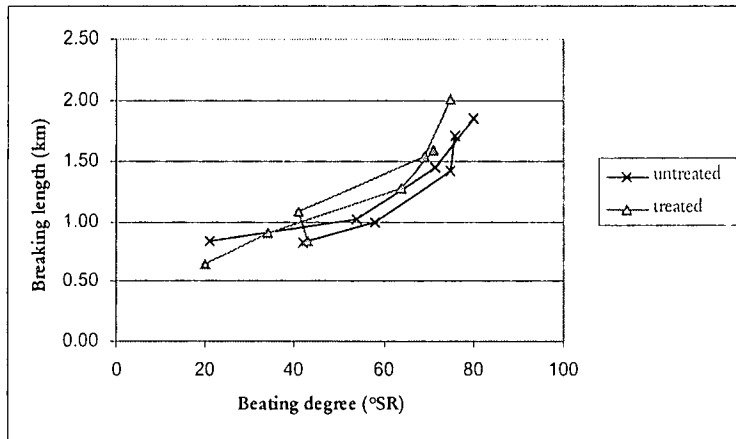

Figure 4.5: Breaking length versus beating degree

The brightness of the *F.lignosus* treated pulps is, at a level of 39 ISO %, in average 1.5 ISO % higher than the brightness of the untreated pulps.

4.2.3 Conclusions

A pre-treatment of simulated RMP green jute pulp with *F.lignosus* results in 10 to 20% savings in energy at the same level of strength properties or beating degree and a 1 to 2 ISO % higher brightness.

The results of this experiment confirm the conclusions from the earlier experiment that were presented in the second progress report.

4.3 The effect of incubation time of the *F. lignosus* pre-treatment on simulated refiner mechanical pulp (RMP) of green jute. (I)

4.3.1 Material and methods

Green jute was treated with *F. lignosus* according to the procedure as described before in this report. The incubation time of the jute with the fungi was varied between 10 and 14 days. Beating in the PFI-mill was always carried out with 12000 revolutions. For each trial an amount of 60 grams of dry matter was incubated, washed and beaten.

4.3.2 Results

The specific energy was always on the level of 2500 kWh/ton, so the treatment did not influence the absorbed energy per impact.

The weight losses were on average 14.2 % higher for the fungal treated samples (Table 4.1). This is the same as measured before and described in progress report 2.

Table 4.1: weight loss due to the fungal pre-treatment and washing step

Incubation time	untreated		treated	
10 days	E*	5.1%	A	16.9%
10 days	F	-3.9%	B	17.2%
12 days	G	3.7%	C	17.7%
12 days	H	-1.7%	D	12.5%
14 days	K	-2.1%	I	10.4%
14 days	L	-0.5%	J	11.3%
	average	0.1%		14.3%

* A-L are codes for the individual experiments as documented in appendix 3

The variation in the measured losses is substantial because of the inhomogeneous jute material, but nevertheless the data gives a good indication of the losses caused by the fungal treatment.

The test results are presented in a Table in appendix 3 and as graphics in appendix 4.

The beating degree (figure 4.6) and strength properties (figure 4.7 and figure 4.8) were both higher for the treated samples, so with the same amount of energy a better beating effect was measured for the treated jute.

The differences were at most at 12 and 14 days of incubation time. It is therefore recommended to apply incubation times between 12 and 14 days.

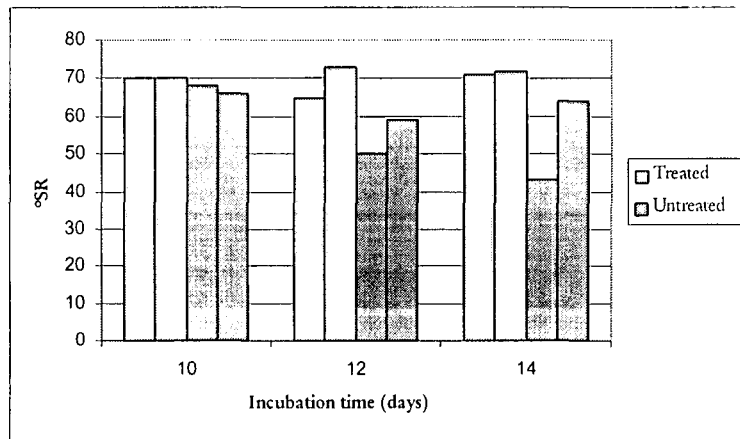

Figure4.6: Beating degree versus incubation time

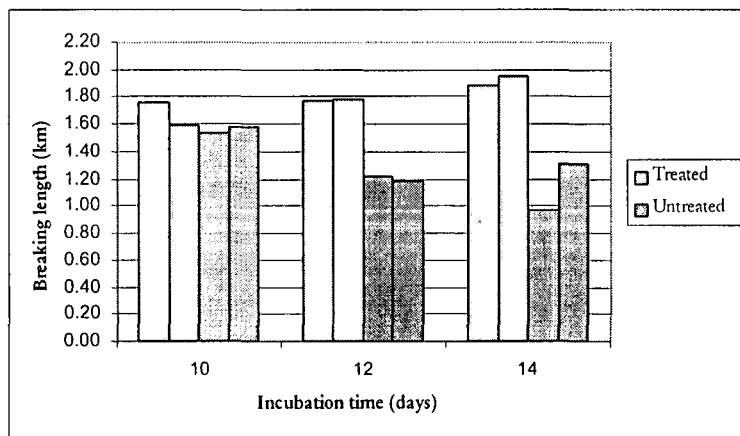

Figure 4.7: Breaking length versus incubation time

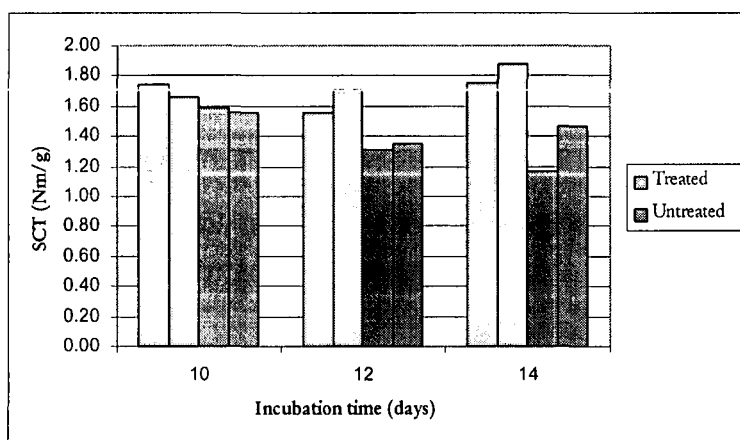

Figure4.8: Short span compression strength versus incubation time

As observed before, the brightness of 10 and 12-day treated pulp is higher (in average 1 ISO%) than the brightness of untreated pulp. However, in the case of incubation for 14 days, the untreated pulps showed the highest brightness (figure 4.9). No explanation could be found for this anomaly. Although the measured brightness is still a little contradictory, in most experiments an improvement of the brightness of 1 to 2 ISO% was measured.

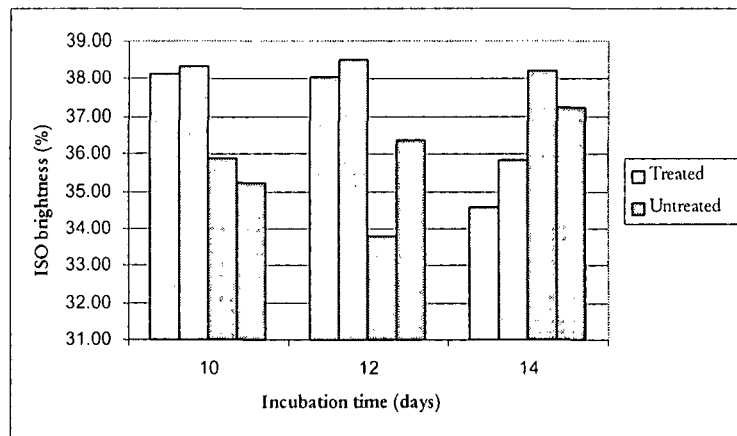

Figure4.9: ISO brightness versus incubation time

4.3.3 Conclusions

An incubation time of 12 to 14 days has more effect on the beating degree and strength properties than an incubation time of 10 days.

If beating is carried out at a fixed number of revolutions, the beating degree and strength properties increase if a *F.lignosus* pre-treatment is applied on green jute.

The measured brightness is still somewhat contradictory, but it can be concluded that *F.lignosus* pre-treatment results in a 1 to 2 ISO % higher brightness. The test needs to be repeated for a conclusive judgement.

4.4 *The effect of incubation time of F. lignosus pre-treatment on simulated refiner mechanical pulp (RMP) of green jute. (II)*

Because of the divergent brightness measurement the previous experiment was repeated under the same conditions.

4.4.1 *Material and methods*

The test was carried out under the same conditions as the previous test.

4.4.2 *The weight loss after pre-treatment and washing was on average 10.9 % higher for the treated green jute (Table 4.2). In both tests the pre-treatment caused an averaged extra loss of 12.5 %.*

Table 4.2: weight loss due to the fungal pre-treatment and washing step

Incubation time	Untreated		Treated	
10 days	G*	-----	A	14.5%
10 days	H	-0.5%	B	3.8%
12 days	I	-1.8%	C	10.7%
12 days	J	2.6%	D	11.8%
14 days	K	4.7%	E	19.2%
14 days	L	1.8%	F	13.8%
	average	1.4%		12.3%

* A-L are codes for the individual experiments as documented in appendix 5

All the test results are presented in a Table in appendix 5 and as graphics in appendix 6. As in the previous experiment, the beating degree (figure 4.10) and strength properties (figure 4.11 and figure 4.12) were both higher for the treated samples, so with the same amount of energy a better beating effect was measured for the treated jute.

In this experiment there is no clear minimum incubation time. The effects at 10 days are not less than at 12 or 14 days. Apparently the growth of the fungi has been different (quicker) than in the previous test.

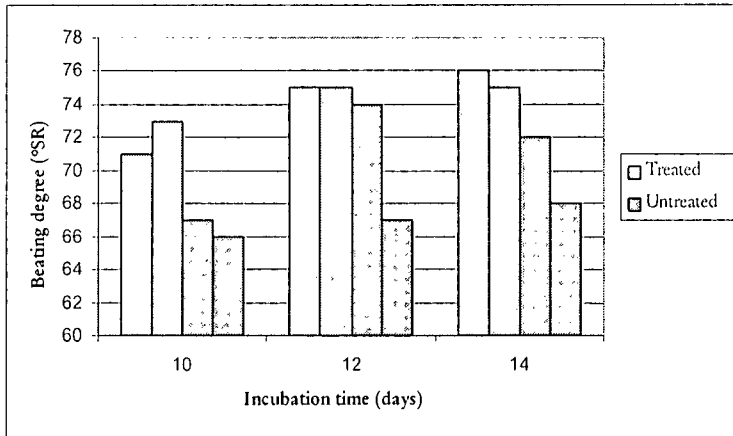

Figure 4.140: Beating degree versus incubation time

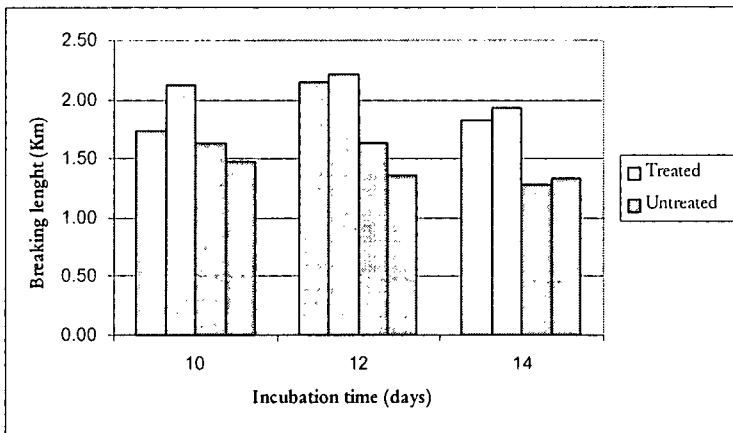

Figure 4.11: Breaking length versus incubation time

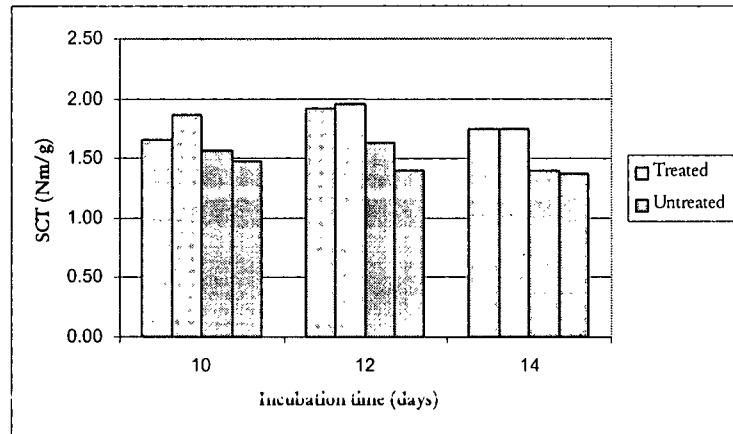

Figure 4.152: Short span compression strength versus incubation time

The average brightness level is 1 ISO % lower than in the previous experiment, but as found before, the brightness is higher for the treated pulp (in average 1 ISO %), (figure 4.13). So again, *F.lignosus* improves the brightness by at least 1 ISO %.

Figure 16: ISO brightness versus incubation time

4.4.3 Conclusions

If beating is carried out on a fixed number of revolutions, the beating degree and strength properties increase with a *F.lignosus* pre-treatment of green jute.

The measured brightness is 1% higher for the *F.lignosus* treated jute.

In this test there is no clear minimum incubation time. The effects at 10 days are not less than at 12 or 14 days. Apparently the growth of the fungi has been different from the previous experiment.

Because no decline of the pulp quality was found after 14 days compared to 10 or 12 days, it is advised to use incubation times of 12 to 14 days to be sure that the fungal treatment is sufficient.

4.5 Microbiological pre-treatment of APMP-PFI pulp (I)

4.5.1 Material and methods

4.5.1.1 Pre-treatment

Green jute was chopped in smaller pieces and subsequently treated with *F. lignosus* as described before, brightened with a hydrogen peroxide bleaching and beaten in a PFI mill. After beating the pulp was analysed and handsheets were made for evaluation.

The size reduction and microbiological treatment was carried out as described in the RMP simulation experiment with an incubation time of 13 days.

4.5.1.2 Brightening

After the fungal pre-treatment the jute was soaked in water at a dry matter content of 5%. Soaking was done during 10 minutes with stirring by hand every 5 minutes. The surplus of water was drained off. The jute was then treated with 0.6% DTPA during 1 hour at 60 °C and 5% consistency. After the DTPA and washing treatment the yield was determined.

The green jute was then bleached with 5% hydrogen peroxide and 5% total alkali in combination with 0.2% Magnesium sulphate and 7% sodium silicate. This bleaching was carried out at 70 °C at 14% consistency during 90 minutes. After bleaching the pulp was diluted to 5% consistency and the pH was corrected to 5-5.5.

To be sure that bleaching would not be hampered, the DTPA and sodium silicate amounts were high. In trials on a more practical scale these amounts can be reduced to a lower and more economic level.

4.5.1.3 Beating

After the bleaching step the green jute was beaten in a PFI mill

Four samples of the treated and washed jute were beaten in a PFI mill at 10% consistency during 500 revolutions with a gap of 2 mm and 500 revolutions with a gap of 1 mm. After these two stages the jute was beaten with a gap of 0 mm and the standard pressure of 3.33 N/mm bar length (66.6 N/cm²) during respectively 6000, 9000, 10500, 12000 and 15000 revolutions. In this way a beating curve of the pulp was made. The beating procedure is a lab scale simulation of the refiner mechanical pulping process (RMP). The energy needed in the stage with a zero gap was measured. The beating degree was limited to about 70 °SR because higher beating degrees would have no practical meaning. After disintegration during 10.000 revolutions in a standard disintegrator, the beating degree (°SR) of the beaten pulp was measured.

4.5.1.4 Evaluation of hand sheets

After disintegration handsheets were made with a Rapid-Köthen sheet former. The hand sheets were tested for grammage, thickness, bulk or density, breaking length, strain, short span compression strength (SCT) and brightness at 50% relative humidity (RH) and 23 °C. Beating, hand sheets making and testing were all performed according to the ISO-standards.

4.5.2 Results

4.5.2.1 Yield

The yield measurements after fungal pre-treatment and DTPA washing were not clear.

4.5.2.2 Energy and Beating degree

The energy needed for beating treated or non-treated jute did not differ significantly. Only one of the untreated pulps (C) needed more energy on three of the four beating degrees (Figure 4.13). All the test results are presented in appendix 7.

There was no significant difference in the beating degree either. The beating degrees of the two treated samples lie between the two samples of the non-treated jute (Figure 4.14).

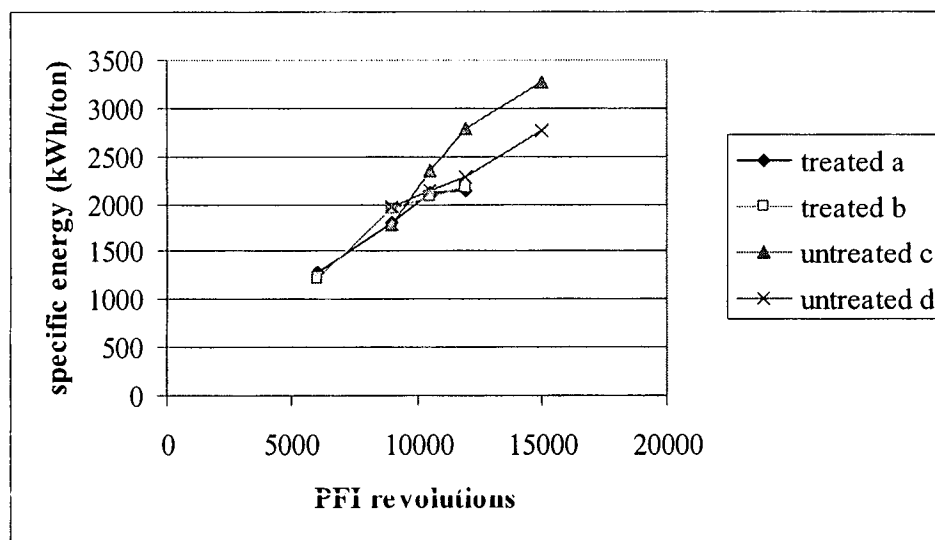

Figure 4.13: Specific energy versus PFI revolutions

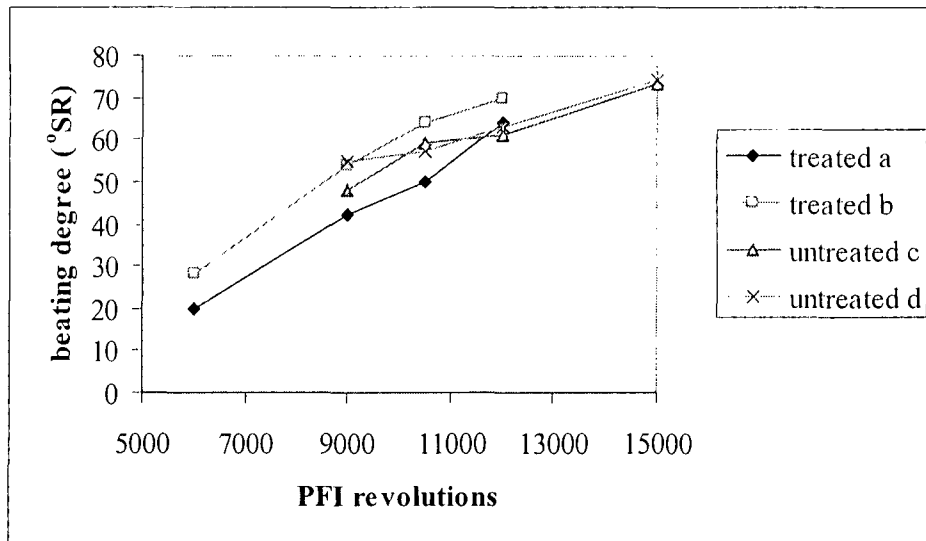

Figure 4.14: Beating degree versus PFI revolutions

4.5.3 Brightness

Brightness was on a lower level than with earlier bleaching APXP and XRP experiments pulps. This is partly caused by the lower consistency level of 14% instead of 20%. The difference in structure of the pulp might also be an important factor. The APXP and the XRP pulps were bleached in a form already suitable for papermaking. In this experiment the bleaching of the jute was done before milling/beating. The bleaching might be more effective on the pulp than on the jute itself. There is no difference between the treated and untreated jute. There are actually two brightness levels found, but both levels consist of treated and untreated jute (Figure 4.15).

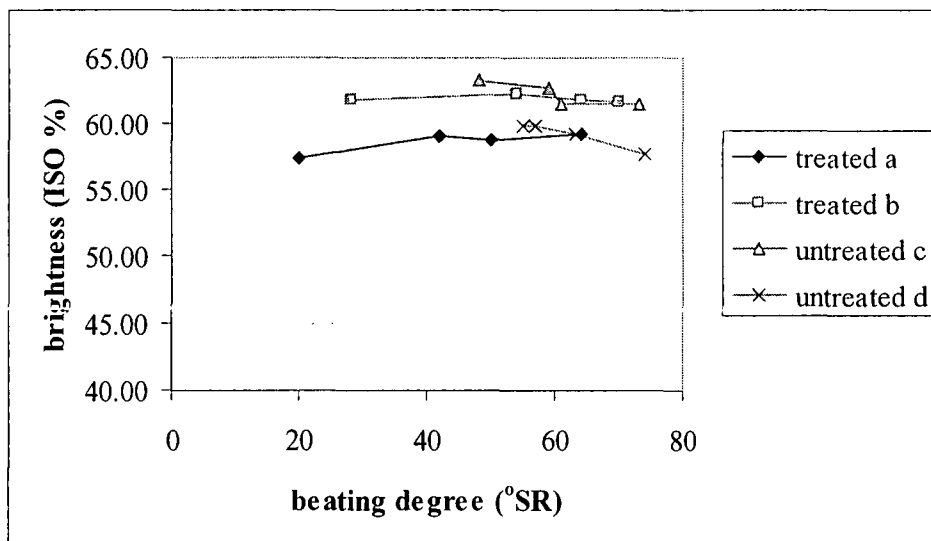

Figure 4.15: Brightness versus beating degree

4.5.3.1 Strength properties

No significant differences were found for the tensile strength and the SCT (Figure 4.16 and Figure 4.17)

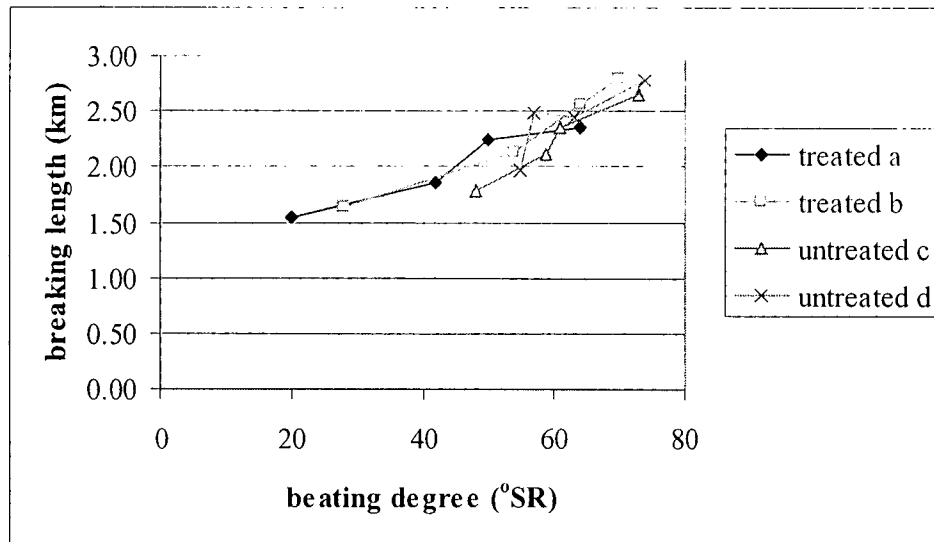

Figure 4.16: Breaking length versus beating degree

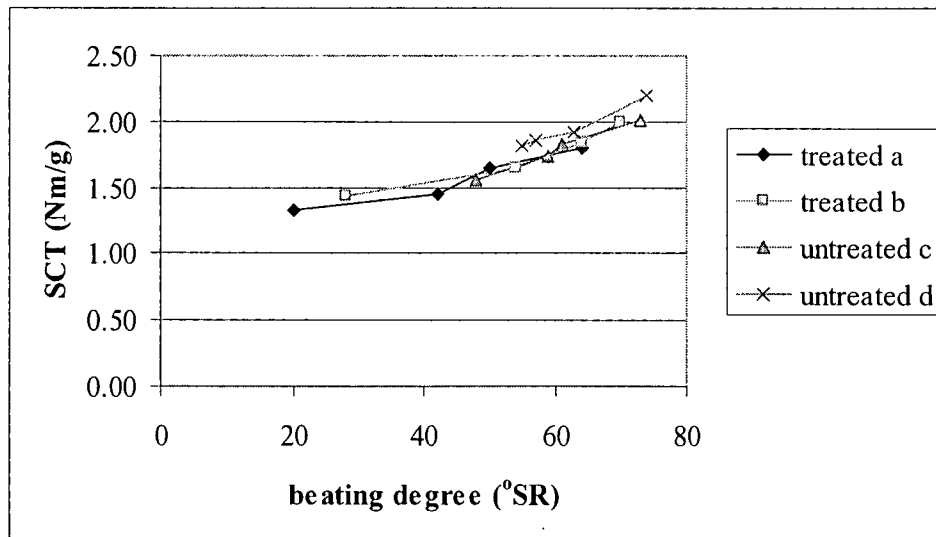

Figure 4.17: Short span compression strength versus beating degree

There is a good linear correlation between the breaking length and the density (Figure 4.19) and a very good linear correlation between the beating degree and the density (Figure 4.20).

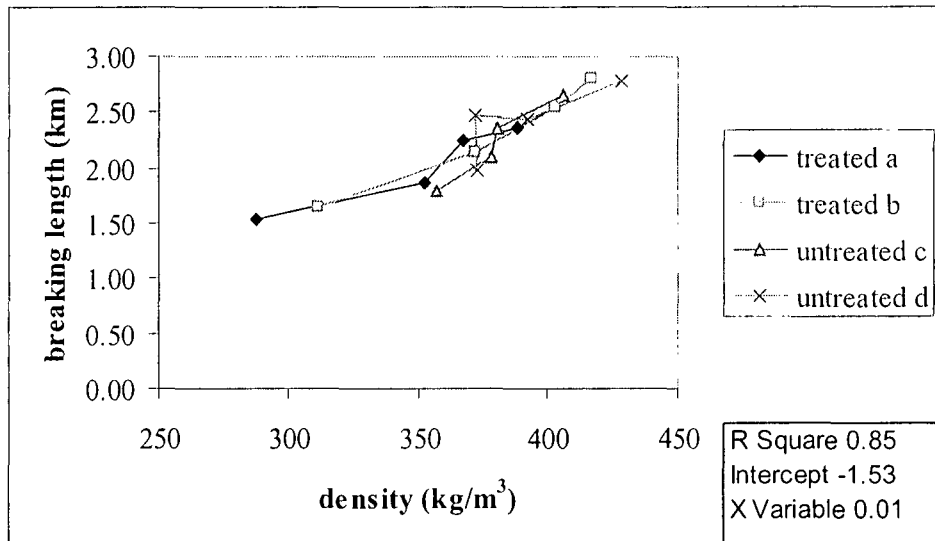

Figure 4.19: Breaking length versus density

Differences between treated and untreated samples are not clear. Because of the great number of different processing steps that are needed to produce a sheet of paper of jute, the variations in results can be high. Those steps include size reduction, pre-treatment, washing, bleaching, beating and making of the paper. The size reduction step is an important step in this procedure. If particles are too large in size, the fungal pre-treatment and the bleaching can be hampered. Beside that, bast fibres that are still long tend to form flocs, which creates extra variation in the ratio of core and bast fibre. Of course this last point is not a problem if the process is carried out on an industrial scale.

For this type of small scale experiments a more homogeneous size distribution and a further reduction to smaller pieces would be beneficial.

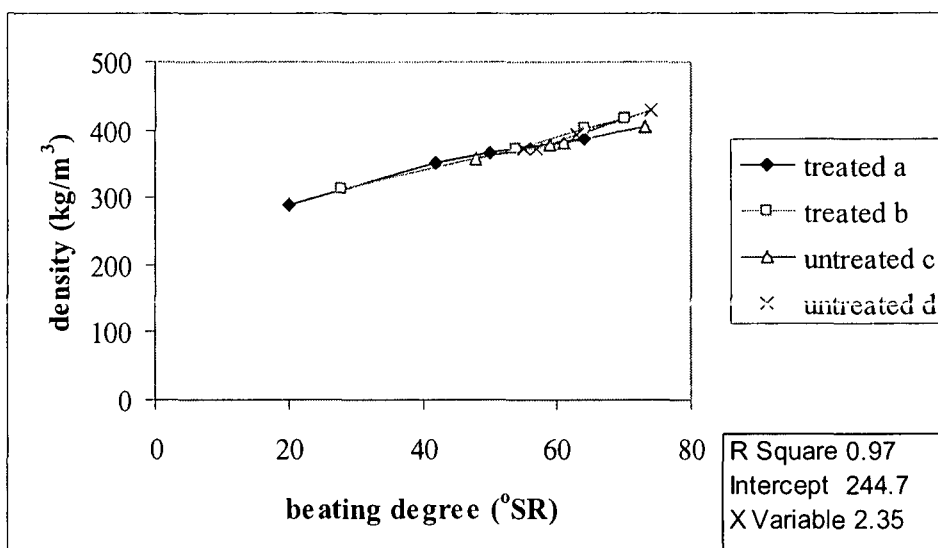

Figure 4.2017: Density versus beating degree

4.5.4 *Conclusions*

There are no significant differences between the treated and untreated samples. The question is; if the differences cannot be measured due to variations in raw material and microbiological treatment or, differences are overruled (overshadowed) by the alkaline peroxide treatment.

The test needs to be repeated.

4.6 *Microbiological pre-treatment of APMP-PFI pulp (II)*

An extra experiment was carried out. In this case small batches were treated and only beaten at a fixed number of revolutions, pre-treatment time was again 13 days. The treatments and the references are repeated 5 times.

4.6.1 *Material and Methods*

The shortening and the microbiological pre-treatment were carried out as described before. But a coarse refining step in a 12" refiner was added to the procedure to create more uniform dimensions of the shortened jute and a more homogeneous mixture of jute bast and core fibre. In this refining step 100 kWh/ton was used. After shortening 5 samples of 50-gram dry matter green jute were treated with *F. lignosus* and 5 samples were not treated. After the microbiological treatment the jute was soaked in water at a dry matter content of 5%. Soaking was done during 10 minutes with stirring by hand every 5 minutes. The surplus of water was drained off. The jute was then treated with 0.6% DTPA during 1 hour at 60 °C and 5% consistency. After the DTPA and washing treatment the yield was determined.

The green jute was then bleached with 5% hydrogen peroxide and 5% total alkali in combination with 0.2% Magnesium sulphate and 7% sodium silicate. This bleaching was carried out at 70 °C at 14% consistency during 90 minutes. After bleaching the pulp was diluted to 5% consistency and the pH was corrected to 5-5.5.

To be sure that bleaching would not be hampered, the DTPA and sodium silicate amounts were high. In trials on a more practical scale these amounts can be reduced to a lower and more economic level.

4.6.2

After this bleaching step the green jute was beaten in a PFI mill during 10000 revolutions.

4.6.3 *Results*

Because of the small scale, measuring of the losses was difficult, but it was possible to get three reliable losses of both treated and untreated green jute after bleaching.

The amount of loss is for the treated samples about 20% higher than for the untreated samples (Table 4.3). Compared to earlier experiments without bleaching step, the difference between treated and untreated samples is small. This means that the main part of the losses caused by the fungal treatment is also removed by the bleaching step.

Table 4.3: weight losses due to fungal pre-treatment, bleaching and washing

Treated		Untreated	
F*	14.3	B	18.6
H	18.2	C	24.2
J	16.6	D	22.2
average	16.4		21.7

* B-J are codes for the individual experiments as documented in appendix 8

In hand sheet making another 10% is not retained on the sieve. This amount cannot be calculated as loss as with re-using of the water, the retention on the sieve will be higher. Another experiment with recycling of the white water is needed to make an estimation of the real retention on the sieve.

Bleaching reduces energy from a level of 2300 kWh/ton to a level of 1700 kWh/ton at 10000 revolutions. An extra *F. lignosus* treatment lowers the energy level to 1600 kWh/ton. So after subtraction of 100 kWh/ton used in the pre-refining, the amount of energy saved by applying this bleaching step was 500 kWh/ton or about 20 %.

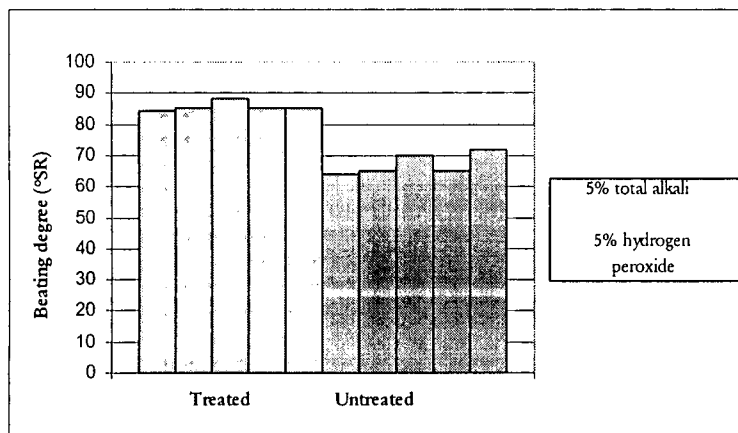

Figure 4.21: Beating degree

Fungal treatment results in a faster development of the beating degree (Figure 4.21). The level of the beating degree of the treated jute is too high for practical applications. The treated jute should be beaten with fewer revolutions, which will result in a lower energy demand. This faster development of the beating degree also results in higher densities and higher strength properties (Figure 4.22 and Figure 4.23). All the test results are presented in appendix 7 and 8.

The extra shortening of the jute results in a better reproducibility than in the previous experiment.

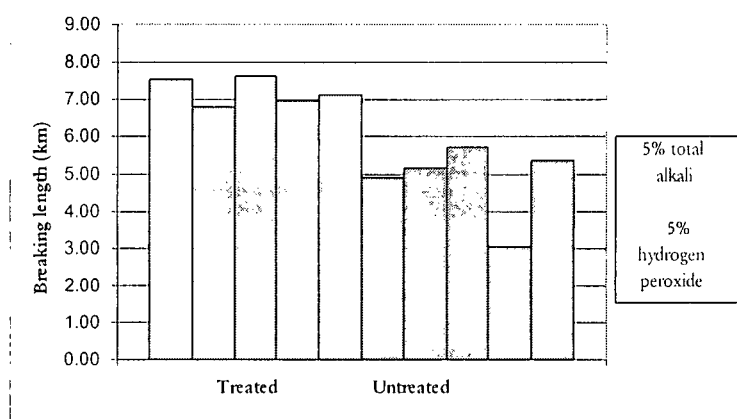

Figure 4.22: Tensile strength

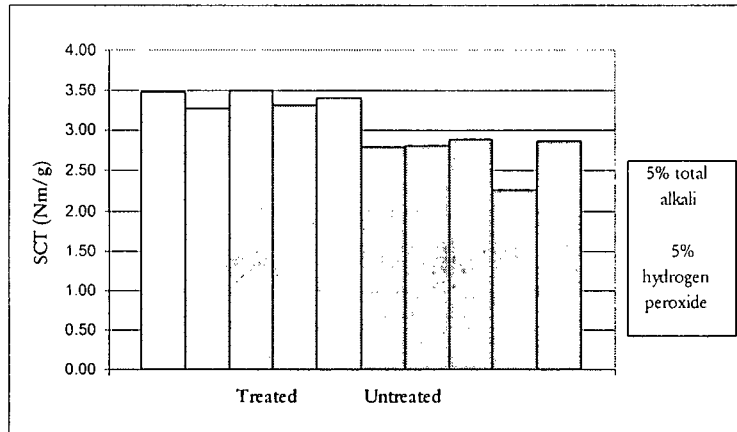

Figure 4.23: Short span compression

Compared to RMP pulps the strength properties and brightness were raised by the alkali peroxide process to a level that makes it possible to use this pulp for the production of newsprint. The brightness was raised from below 40 ISO % to above 60 ISO %. A clear effect of the fungal treatment on the brightness could not be measured (Figure 4.24). Probably, the small brightening effect of *F. lignosus* is overshadowed by the brightening effect of the peroxide treatment. The average brightness in this experiment was 63.2 ISO %, which is 2.7 % higher than in the first APMP simulation experiment. So apparently the extra size reduction in the pre-refining in combination with the higher dry matter content during bleaching was beneficial. After the bleaching step about 90% of the Hydrogen Peroxide was consumed and the pH was around 9.

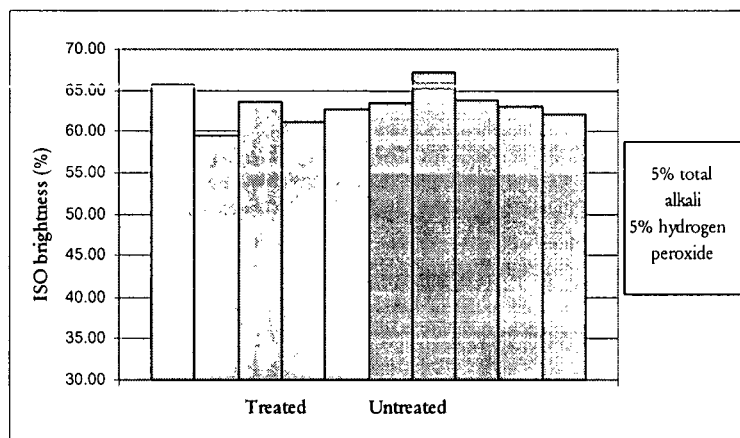

Figure 4.2418: ISO brightness

4.6.4 *Conclusions*

The losses caused by the consecutive treatments were 16.4 % for the untreated and 21.7% for the fungal treated green jute. The difference between treated and untreated jute is much smaller than with the RMP process. Apparently most of the mass that is consumed or solved by the fungi is solved by the alkaline peroxide process too.

To reach the same level of beating degree or strength less beating and less energy is needed.

The alkaline peroxide treatment raised the brightness of both the treated and untreated to a level of 60 to 65 ISO %. No clear effect of the treatment on the brightness could be measured upon this level.

The alkaline peroxide process step raises the brightness and strength properties of the hand sheets of green jute so much that it becomes suitable for newsprint.

The extra size reduction in a pre-refining step in combination with a higher consistency during bleaching resulted in a higher brightness and a better reproducibility.

Advised Further work

Alkaline Peroxide (APMP) experiments with untreated and pre-treated green jute in a 12" pressurised refiner.

4.7 Production of APMP pulps on a 12" inch refiner

4.7.1 Material and methods

The material used was from the first received batch of green jute. The jute was chipped in a wood chipper and subsequently cut in a cutting mill (Pallmann) equipped with a sieve of 15 x 15 mm. These particles are further reduced in size by a pressing step as described below. In the laboratory experiments this further reduction in size was found beneficial for the bleaching step.

4.7.2 Pre-treatment

The jute was soaked in hot water of 70 °C for half an hour. After soaking the surplus of water was drained. This soaking treatment was repeated once and subsequently the jute was soaked with water of 70 °C and 0.6 % of DTPA on dry matter for one night (about 16 hours) in an isolated vessel and drained again. After draining the jute was pressed in the Multiple screw device (MSD) of the refiner to a dry matter content of about 50 %. The jute was further reduced in size by this pressing action. This will also happen when production is on an industrial scale, in that case chips are always fed to a refiner with this kind of equipment.

4.7.3 Bleaching and first stage refining

The chemicals were added and mixed before refining. On dry mass 0.2% of $\text{MgSO}_4 \cdot 7\text{H}_2\text{O}$, 7% of Sodium silicate solution of 38 Bé (s.g.(1.37) , 5% total alkali and 5% of H_2O_2 was added. The chemicals were added after solution in warm water and mixed by hand and in a ribbon mixer for one minute. The consistency was 20%. The jute was then added to the pre-heated storage bin of the refiner and steamed at atmospheric pressure for 10 minutes. Refining was carried out with refiner plates of type D2A505 NH and at a plate gap of 0.2 mm. The refining temperature was 128 and 131 °C and the average residence time at this temperature was 14 minutes. After refining the pulp was held in an isolated vessel for another hour at 70°C.

4.7.4 Washing

The bleached and refined pulp was washed three times with cold water at a consistency of about 7% in the above-mentioned vessel. After diluting to this consistency with cold water, the pulp was stirred by hand and after a residence time of 15 minutes the diluted pulp was drained. This procedure was repeated three times. The pulp was then squeezed to a consistency of about 15%.

4.7.5 *Atmospheric refining*

A second stage of refining of the pulp was applied under atmospheric conditions. The applied plate distance was 0.15, 0.1 and 0.75 mm. The refining temperature varied between 37 and 55 °C and the consistency was between 2.5 and 3%.

4.7.6 *Making of hand sheets*

60 grams of pulp was disintegrated during 10,000 revolutions. For latency release the pulp was first disintegrated in hot water during 5000 revolutions. After 45 minutes of residence time another 5000 revolutions of disintegration were carried out. Hand sheets were made of the first and second stage pulps.

4.8 Results

4.8.1 Pre-washing, refining and washing

The washing step before the refining stage resulted in yields of 95 and 100% (Table 4.4) for the untreated jute. The washing water had a brown colour. The water from the DTPA treatment was also coloured brown. Refining of the jute went very smoothly with only 115 and 87 kWh/ton. Washing after bleaching gave yellow washing water. The yield of this three stage washing water was 82 and 80%. In handling the pulp extra losses are created, so the measured yield will be a little bit higher if it is carried out at an industrial scale.

	losses after pre-washing (%)	Losses after refining and bleaching (%)	Total losses (%)	Specific energy (kWh/ton)
Run R30708	5	18	23	115
Run R30710	0	20	20	92

The average total yield after pressing, bleaching, refining and washing was 78.9%, which is comparable with the laboratory scale APMP experiment. This is about 6% lower than e.g. for an aspen CTMP pulp.

As can be seen the specific energy and beating degree do not always coincide with the used plate gap (Table 4.4). This is explained by the fact that accurate plate gap adjusting was not always possible.

The total specific energy needed to reach a beating degree level of 50 to 60 °SR was at most 500 kWh/ton (table 4.5). This is low compared to 2000 kWh/ton, which is normal in wood refining.

Table 4.5:	Plate gap	Total Specific energy (KWh/ton)	Beating degree (°SR)
Run R30708	1.5	251	29
	1	339	60
	0.75	339	48
Run R30710	1.5	500	46
	1	405	52
	0.75	346	47

4.8.2 Pulp and Paper properties

All the measured hand sheet properties are given in appendix 1. As expected the density of the handsheets increases with the beating degree (Figure 4.25).

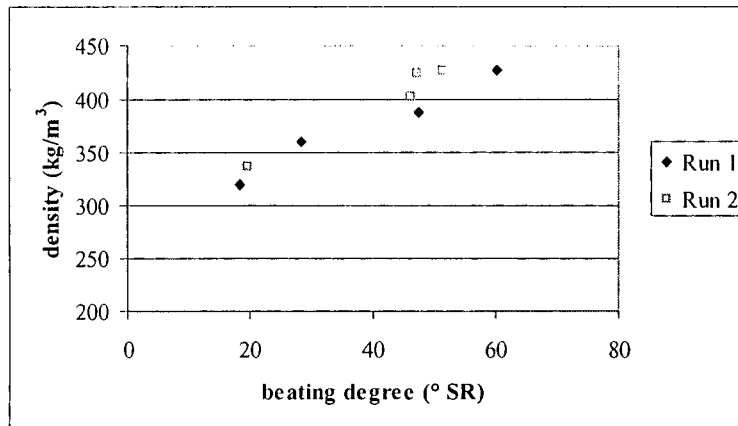

Figure 4.25: Density versus beating degree

The ISO brightness of the second stage pulps varied between 62.5 and 64. The first stage pulps were 1 to 2 points lower than the second stage pulps. The hydrogen peroxide was almost completely consumed and the pH was around 8.

As shown on lab scale before, brightness can be raised to over 70 ISO %. Compared to the lab trials this pulp had a higher temperature treatment, so applying a lower temperature in the first refiner stage might result in a higher brightness.

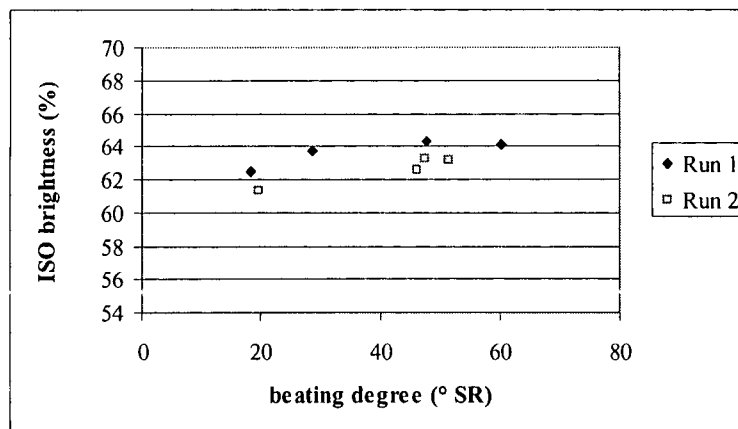

Figure 4.2519: ISO brightness versus beating degree

The maximum breaking length is reached with run 1, this is also the run with the lowest brightness (Figure 4.26). Probably a difference in used alkali creates these differences.

There exists a good linear relationship between the density and the tensile strength (Figure 4.27).

The produced APMP pulps are much stronger and brighter than the TMP pulps produced earlier. These APMP pulps can be used for newsprint.

The produced APMP pulp had a lower strength and higher bulk than the APMP pulp produced by CTP. The high strength and density at CTP was due to a high chemical supply, which creates a pulp with properties that are close to chemical pulps. The brightness reached with the one stage process at ATO was as high as after two stages at CTP.

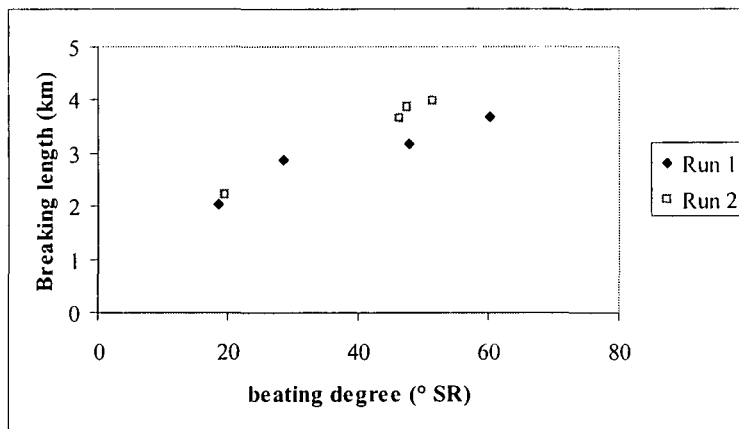

Figure 4.26: Breaking length versus beating degree

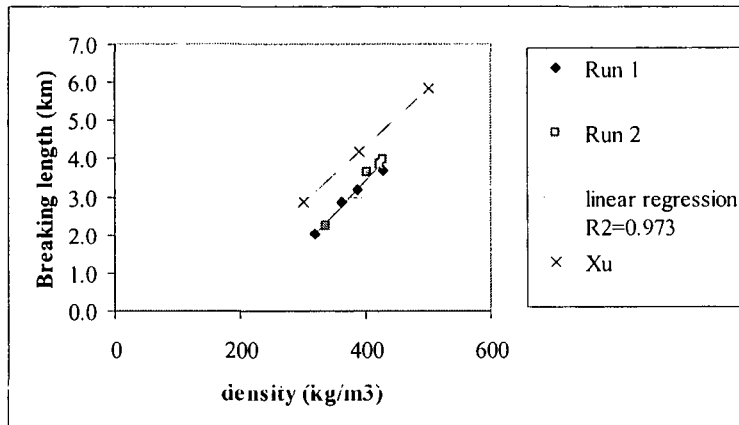

Figure 4.27: Breaking length versus density

4.8.3 *Conclusions*

Green jute can be used to produce newsprint pulp with the APMP process. The needed specific energy is very low compared to mechanical pulps from wood.

The average total yield after pressing, bleaching, refining and washing was 78.9%, which is comparable with the laboratory scale APMP experiment.

Appendix 1: Test results simulated RMP in PFI-mill experiment

	kWh/ton	PFI revolutions	drainability (°SR)	grammage (g/m ²)	thickness (µm)	density (kg/m ³)	breaking length (km)	tensile index (Nm/g)	E-modulus (Gpa)	strain (%)	SCT (Nm/g)	ISO brightness
Untreated A	2324	9000	21	104.72	362	241	0.85	8.30	0.59	0.68	1.04	33.52
Untreated A	2702	12000	54	86.64	290	350	1.02	9.98	0.69	0.63	1.09	37.61
Untreated A	2927	15000	72	94.92	260	357	1.44	14.17	1.05	0.71	1.44	37.23
Untreated A	3368	18000	80	91.48	244	379	1.85	18.14	1.30	0.76	1.72	36.76
Untreated B	2083	9000	42	114.02	305	306	0.83	8.13	0.82	0.53	0.97	37.01
Untreated B	2468	12000	58	99.89	245	326	1.00	9.81	0.93	0.60	1.14	38.50
Untreated B	2992	15000	75	90.15	262	352	1.42	13.96	1.03	0.67	1.48	36.51
Untreated B	3673	18000	76	91.35	248	376	1.71	16.73	1.20	0.77	1.58	38.57
Treated C	1256	6000	20	95.49	350	290	0.65	6.36	0.51	0.49	0.85	37.94
Treated C	2056	9000	34	107.40	309	344	0.90	8.84	0.75	0.61	1.03	37.89
Treated C	2610	12000	64	87.22	277	380	1.28	12.53	0.89	0.65	1.28	39.13
Treated C	2646	13500	71	88.94	259	386	1.59	15.61	1.11	0.72	1.49	38.63
Treated D	1260	6000	43	86.45	323	269	0.84	8.20	0.58	0.55	1.12	39.01
Treated D	1827	9000	41	85.82	290	325	1.09	10.72	0.75	0.65	1.10	40.70
Treated D	2354	12000	69	101.54	254	378	1.54	15.10	1.24	0.79	1.53	39.62
Treated D	2703	13500	75	96.77	242	382	2.01	19.72	1.45	0.87	1.75	39.07

Appendix 2: Graphic presentation of the test results simulated RMP in PFI-mill experiment

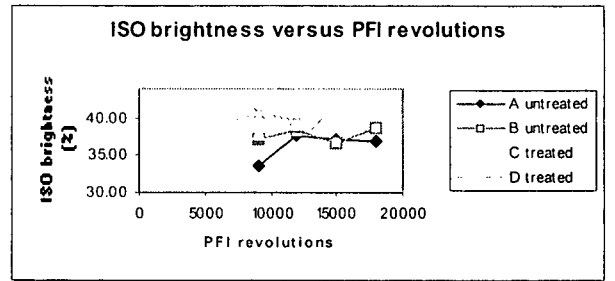
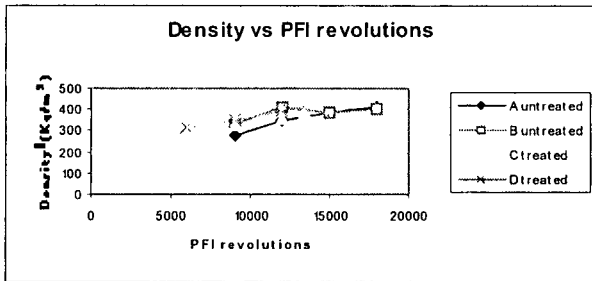
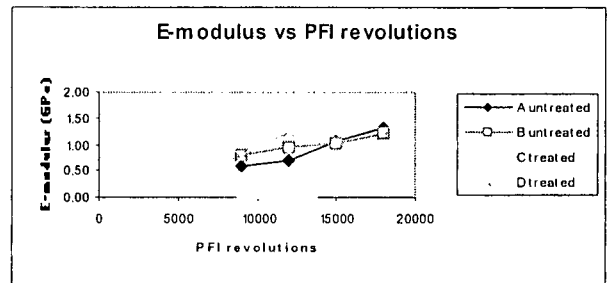
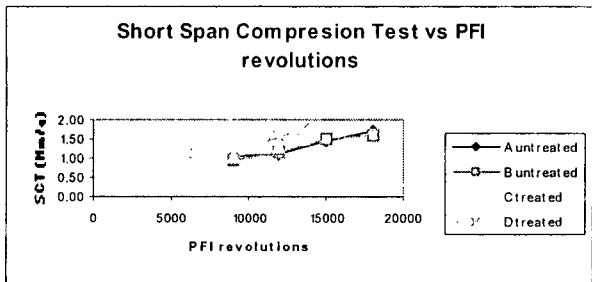
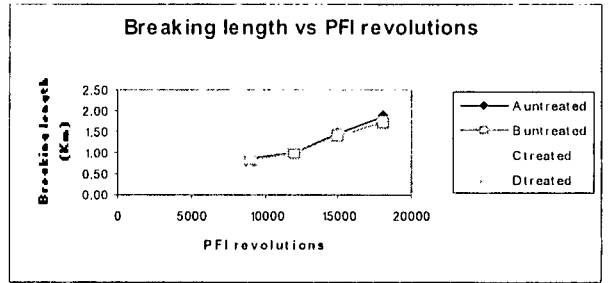
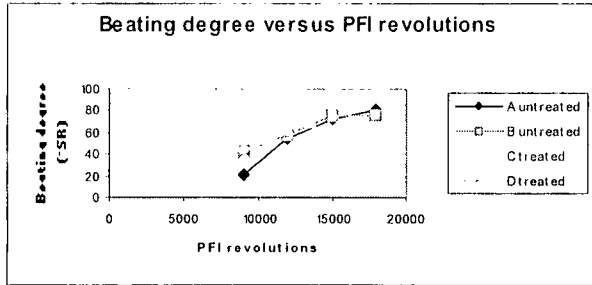

Appendix 2: Graphic presentation of the test results simulated RMP in PFI-mill experiment

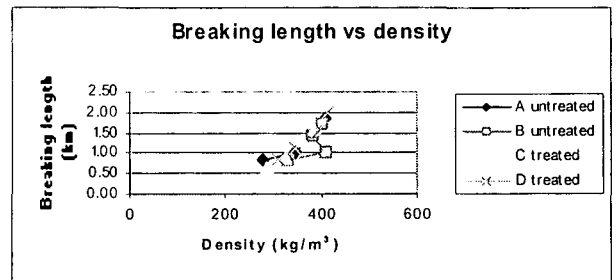
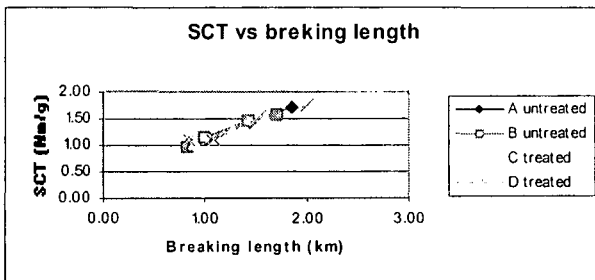
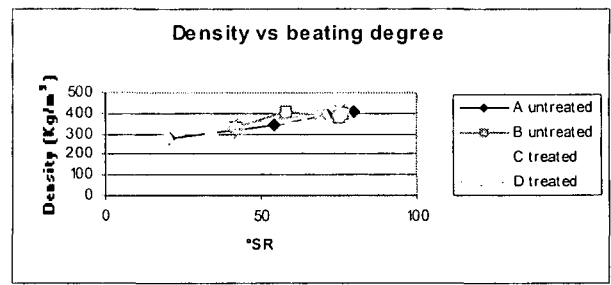
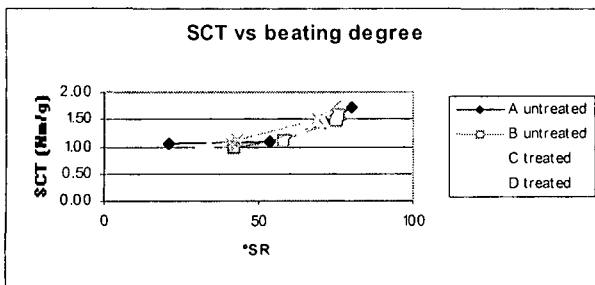
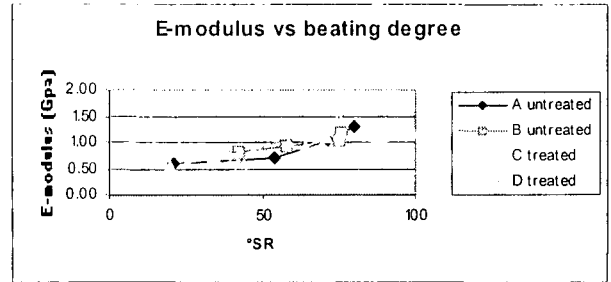
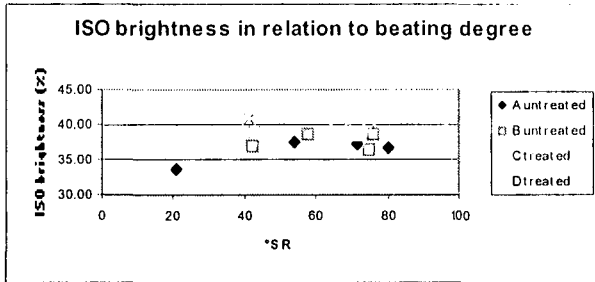

Appendix 2: Graphic presentation of the test results simulated RMP in PFI-mill experiment

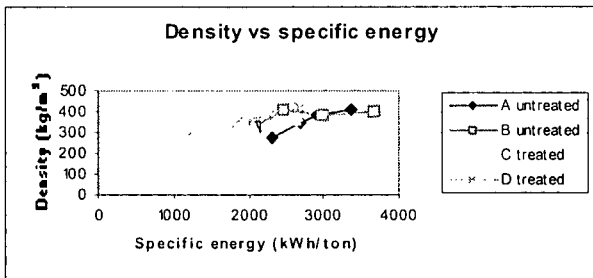
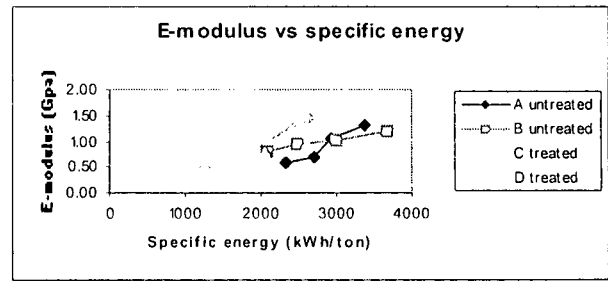
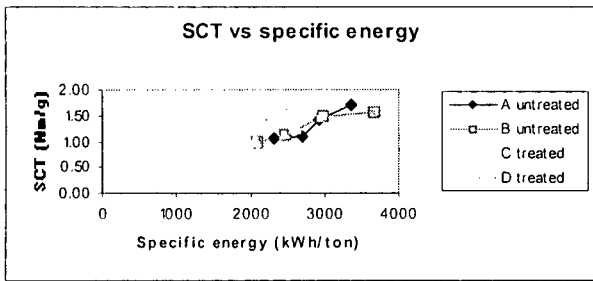
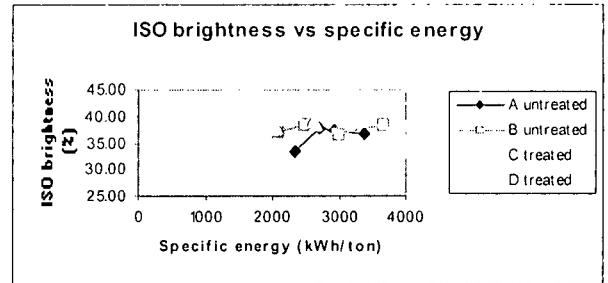
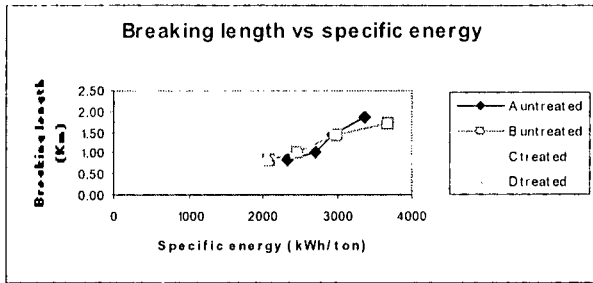

Appendix 3: Test results of the first experiment on the incubation time

	kWh/ton	PFI	revolutions	drainability (°SR)	grainage (g/m ²)	thickness (µm)	density (kg/m ³)	breaking length (km)	tensile index (Nm/g)	E-modulus (Gpa)	strain (%)	SCT (Nm/g)	ISO brightness
treated A (12 days)	2411	12000	65	87.98	243	412	1.77	17.39	1.19	0.81	1.56	38.06	
treated B (12 days)	2346	12000	73	85.56	244	410	1.79	17.54	1.16	0.80	1.71	38.53	
treated C (14 days)	2660	12000	71	88.43	241	414	1.88	18.43	1.24	0.84	1.76	34.57	
treated D (14 days)	2358	12000	72	83.14	237	422	1.95	19.09	1.20	0.86	1.87	35.83	
untreated E (12 days)	3058	12000	50	85.31	291	344	1.22	11.97	0.78	0.68	1.31	33.78	
untreated F (12 days)	2581	12000	59	85.01	274	364	1.18	11.60	0.78	0.68	1.35	36.38	
untreated G (14 days)	2625	12000	43	91.04	283	354	0.97	9.54	0.72	0.64	1.16	38.23	
untreated H (14 days)	2467	12000	64	85.18	263	380	1.31	12.85	0.88	0.70	1.46	37.23	
treated I (10 days)	2454	12000	70	89.32	250	401	1.76	17.30	1.20	0.77	1.74	38.12	
treated J (10 days)	2311	12000	70	85.37	251	399	1.59	15.57	1.07	0.70	1.66	38.33	
untreated K (10 days)	2566	12000	68	86.77	257	389	1.53	15.03	1.04	0.72	1.59	35.90	
untreated L (10 days)	2487	12000	66	87.73	259	386	1.58	15.47	1.05	0.77	1.56	35.23	



Appendix 4: Graphic presentation of the test results of the first experiment on the incubation time

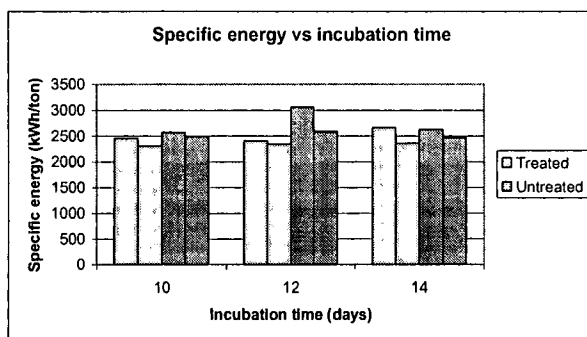
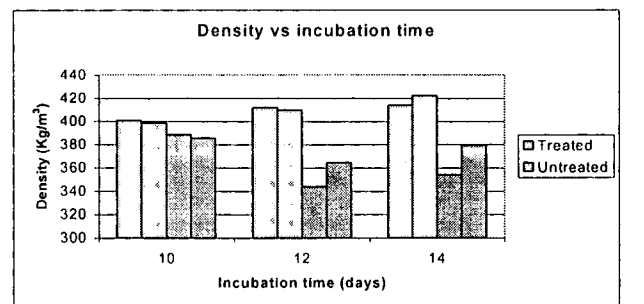
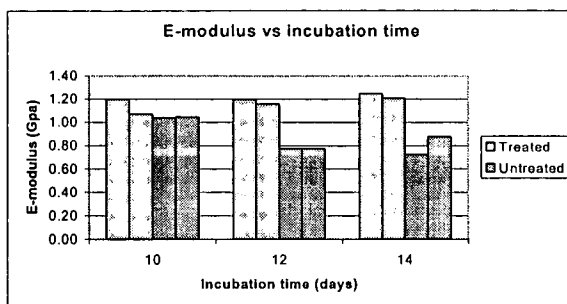
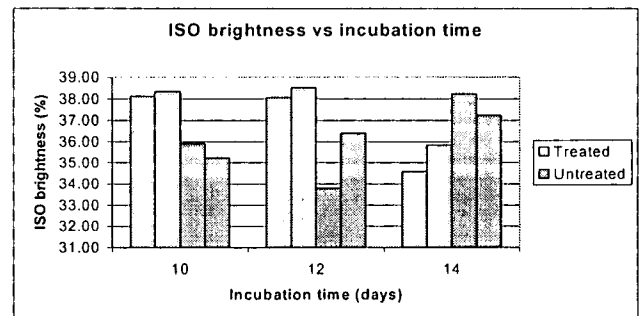
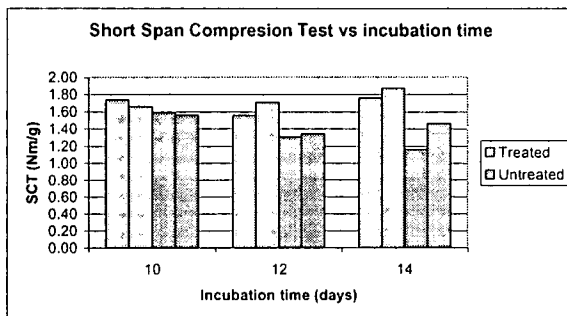
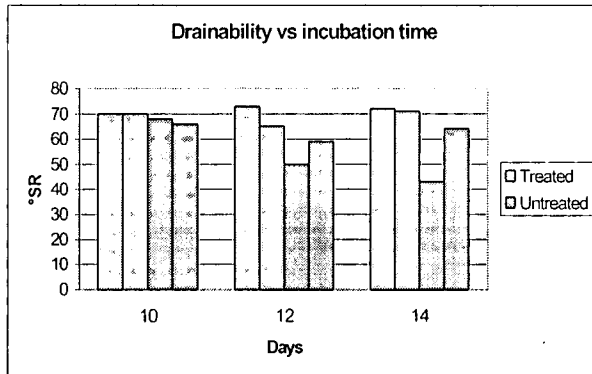

Appendix 4: Graphic presentation of the test results of the first experiment on the incubation time

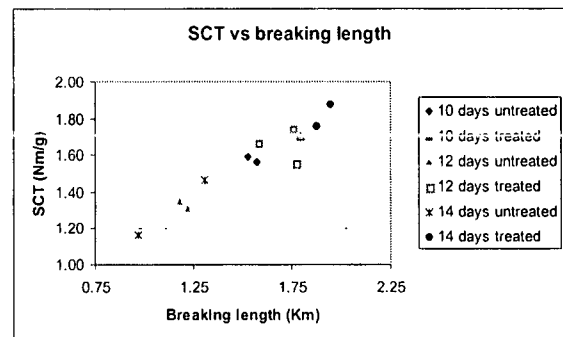
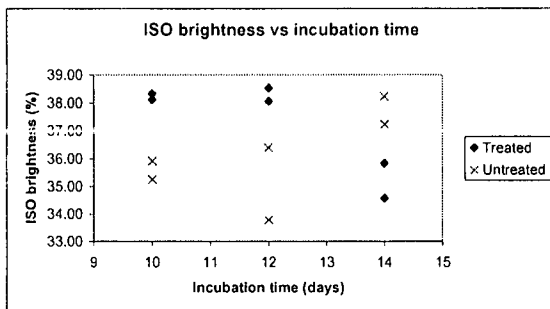
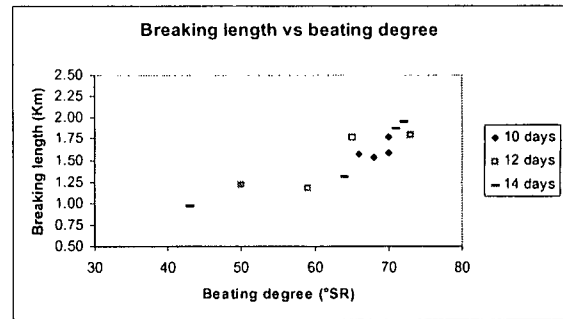
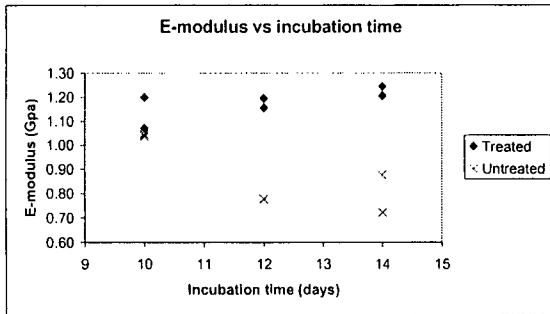
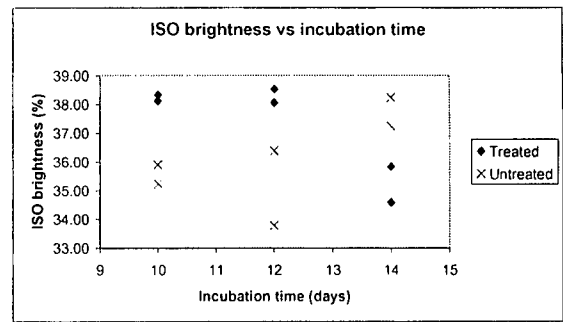
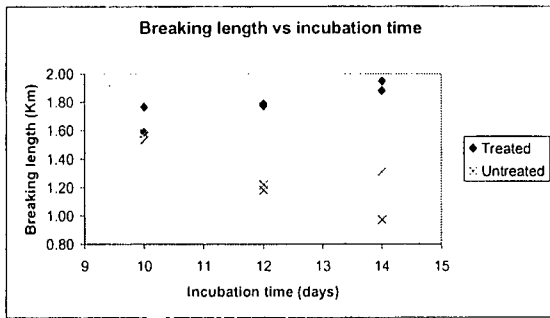
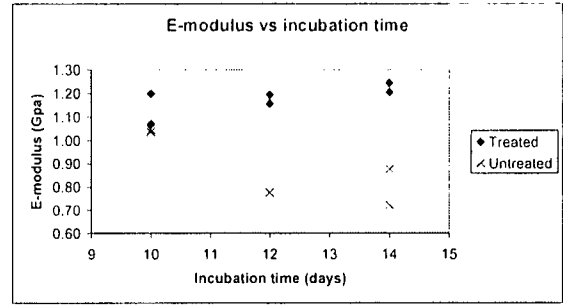
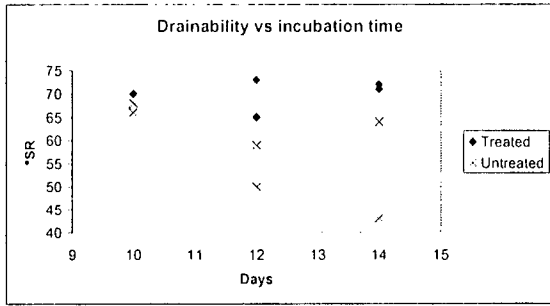

Appendix 5: Test results of the second experiment with different the incubation time

	kWh/ton	PFI	revolutions	drainability (°SR)	grammage (g/m ²)	thickness (μ m)	density (kg/m ³)	breaking length (km)	tensile index (Nm/g)	E-modulus (Gpa)	strain (%)	SCT (Nm/g)	ISO brightness
treated A (10 days)	2657	12000	71	82.38	244	411	16.99	1.73	1.11	0.75	1.65	35.82	
treated B (10 days)	2321	12000	73	84.22	237	422	20.86	2.13	1.34	0.88	1.86	35.39	
treated C (12 days)	2248	12000	75	81.68	234	427	21.12	2.15	1.29	0.88	1.91	35.57	
treated D (12 days)	2323	12000	75	80.02	235	425	21.72	2.21	1.29	0.88	1.95	35.25	
treated E (14 days)	2514	12000	76	78.30	245	407	17.95	1.83	1.06	0.82	1.75	38.49	
treated F (14 days)	2463	12000	75	83.21	244	411	18.92	1.93	1.19	0.85	1.75	36.85	
untreated G (10 days)	2520	12000	67	81.11	264	379	16.05	1.64	1.00	0.77	1.56	33.86	
untreated H (10 days)	2634	12000	66	85.82	265	378	14.43	1.47	0.96	0.71	1.48	35.89	
untreated I (12 days)	2537	12000	74	76.08	256	391	16.02	1.63	0.96	0.73	1.63	34.74	
untreated J (12 days)	2925	12000	67	79.51	273	366	13.38	1.36	0.82	0.67	1.40	35.68	
untreated K (14 days)	2550	12000	72	85.12	270	371	12.57	1.28	0.86	0.65	1.39	35.57	
untreated L (14 days)	2856	12000	68	82.76	269	371	13.12	1.34	0.85	0.68	1.38	34.76	

Appendix 6: Graphic presentation of the test results of the second experiment with different the incubation time

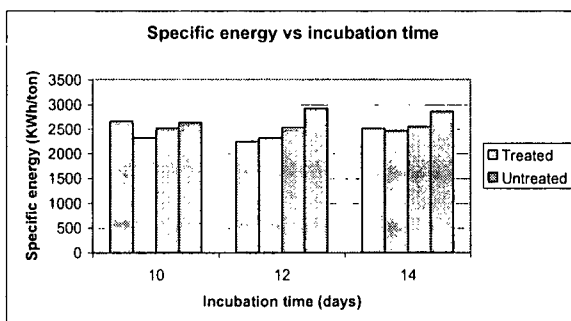
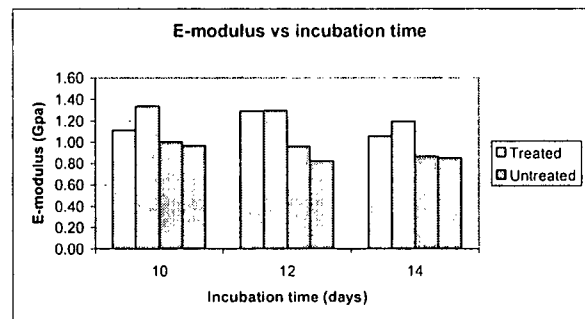
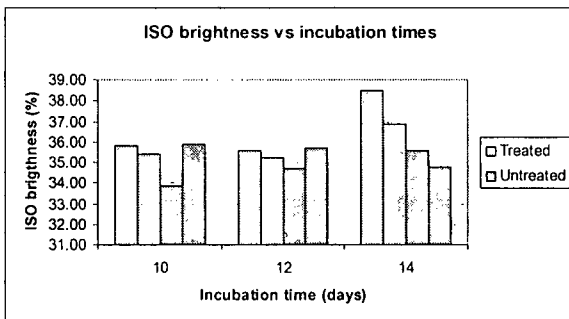
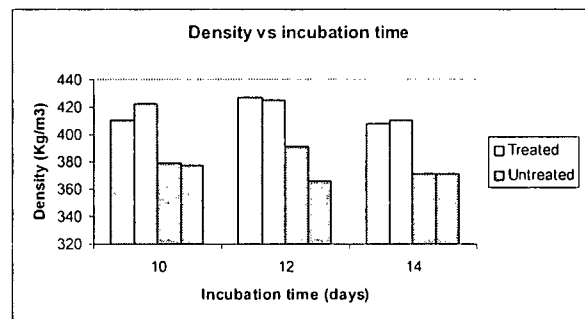
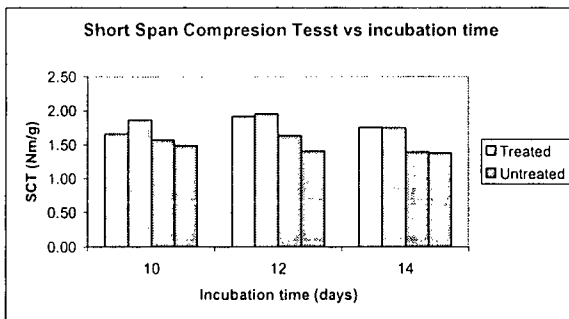
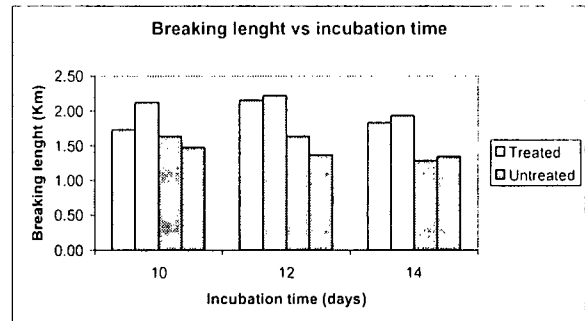
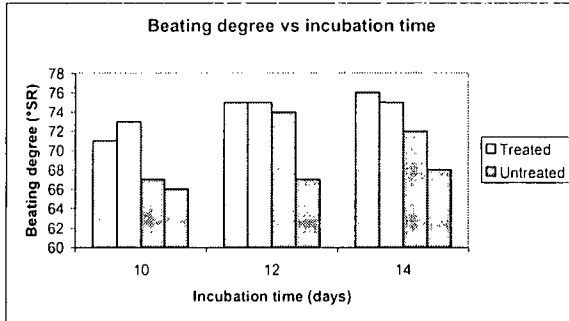

Appendix 6: Graphic presentation of the test results of the second experiment with different the incubation time

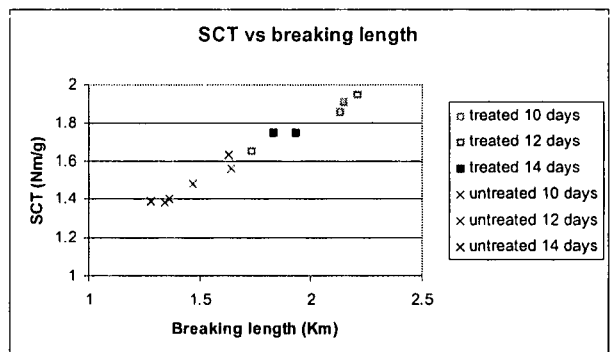
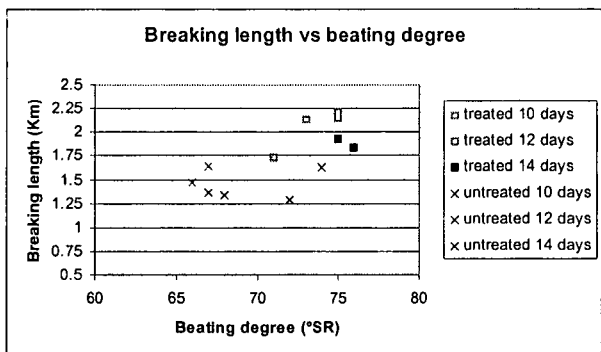
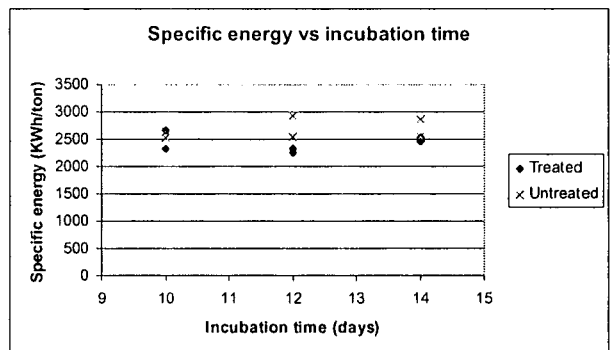
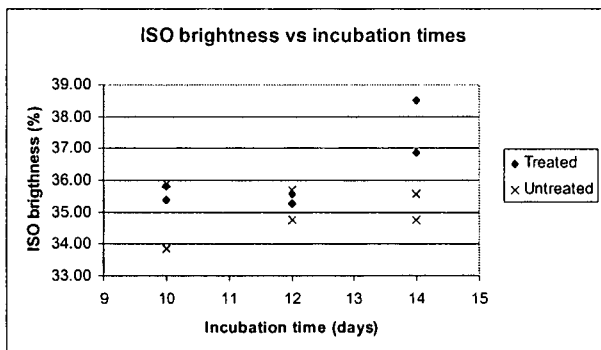
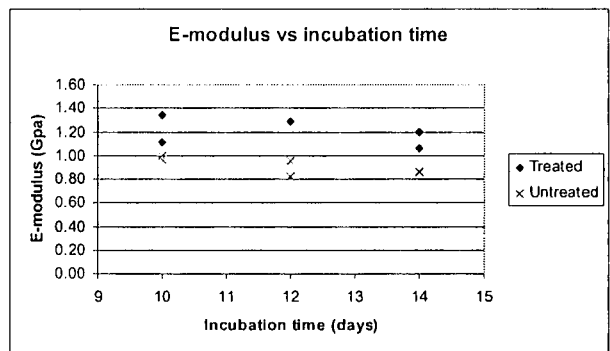
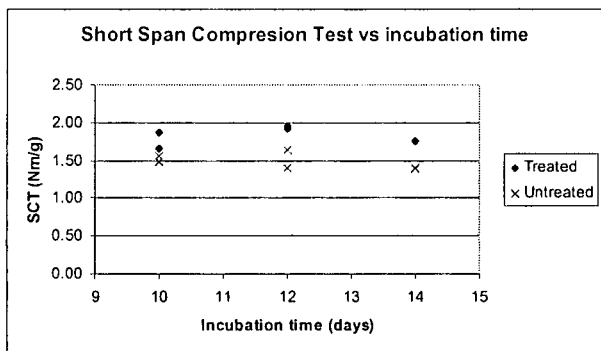
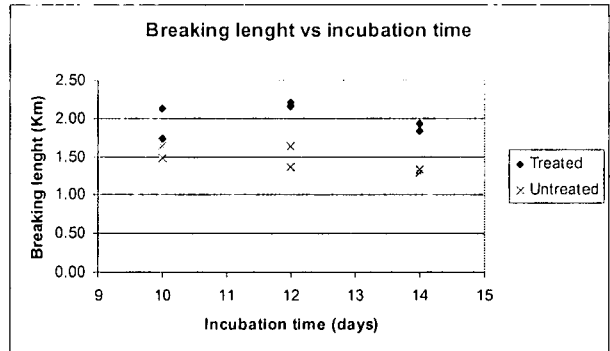
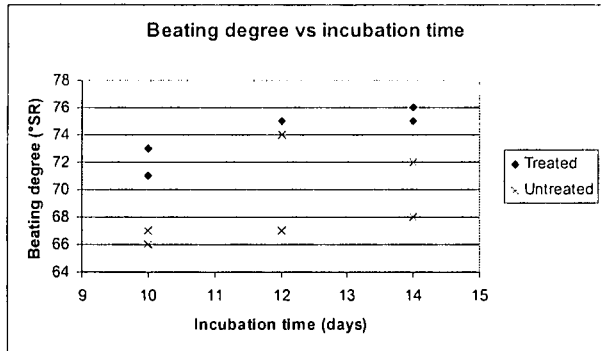

Appendix 7: Test results of the first experiment of APMP simulated PFI-mill

	energy (kW/ton)	PFI revolutions	drainability (°SR)	grammage (g/m ²)	density (kg/m ³)	breaking length (km)	tensile index (Nm/g)	E-modulus (Gpa)	strain (%)	SCT (Nm/g)	ISO brightness (%)
treated A	1287	6000	20	80.2	288	1.5	15.1	0.66	0.90	1.33	57.5
treated A	1808	9000	42	81.9	353	1.9	18.3	0.94	0.94	1.45	59.1
treated A	2125	10500	50	83.8	367	2.3	22.1	1.23	0.97	1.64	58.8
treated A	2147	12000	64	78.6	388	2.4	23.1	1.19	1.03	1.81	59.3
treated B	1213	6000	28	66.8	312	1.6	16.2	0.70	0.78	1.44	61.9
treated B	1956	9000	54	62.5	372	2.1	21.0	0.89	0.91	1.64	62.2
treated B	2069	10500	64	80.3	403	2.5	25.0	1.33	1.11	1.85	61.8
treated B	2189	12000	70	81.6	417	2.8	27.5	1.48	1.14	1.99	61.6
untreated C	1784	9000	48	66.1	357	1.8	17.5	0.81	0.78	1.55	63.3
untreated C	2353	10500	59	78.1	378	2.1	20.7	1.16	0.84	1.73	62.7
untreated C	2795	12000	61	75.7	381	2.4	23.1	1.17	0.93	1.83	61.5
untreated C	3277	15000	73	73.3	406	2.7	26.1	1.28	1.00	2.01	61.5
untreated D	1961	9000	55	75.6	373	2.0	19.4	1.03	0.86	1.81	59.9
untreated D	2145	10500	57	75.2	372	2.5	24.3	1.16	1.05	1.86	59.8
untreated D	2292	12000	63	75.4	392	2.4	23.9	1.22	0.94	1.92	59.2
untreated D	2764	15000	74	75.9	429	2.8	27.3	1.40	1.08	2.19	57.7

Appendix 8: Test results of the second experiment of APMP simulated PFI-mill

	kWh/ton	PFI	revolutions	drainability (°SR)	grammage (g/m ²)	thickness (µm)	density (kg/m ³)	breaking length (km)	tensile index (Nm/g)	E-modulus (Gpa)	strain (%)	SCT (Nm/g)	ISO brightness
GJ-FL-A-treated	1601	10000	84	77.99	155	644	7.54	73.92	3.88	2.00	3.49	65.60	
GJ-FL-B-treated	1602	10000	85	82.76	169	593	6.78	66.54	3.56	1.88	3.27	59.50	
GJ-FL-C-treated	1617	10000	88	85.75	144	694	7.64	74.91	4.70	1.95	3.51	63.68	
GJ-FL-D-treated	1662	10000	85	85.12	162	618	6.97	68.36	3.99	1.76	3.32	61.08	
GJ-FL-E-treated	1531	10000	85	82.51	161	623	7.13	69.92	3.82	1.91	3.41	62.66	
GJ-FL-F-untreated	1690	10000	64	80.47	198	505	4.94	48.44	2.43	1.59	2.80	63.51	
GJ-FL-G-untreated	1850	10000	65	83.08	200	503	5.15	50.48	2.50	1.84	2.82	67.20	
GJ-FL-H-untreated	1634	10000	70	80.66	193	519	5.71	56.04	2.77	1.71	2.90	63.79	
GJ-FL-I-untreated	1789	10000	65	78.94	233	429	3.05	29.91	1.65	1.05	2.26	62.99	
GJ-FL-J-untreated	1767	10000	72	86.83	193	518	5.37	52.71	2.75	1.81	2.87	62.02	

Appendix 9: Graphic presentations of the test results of the second experiment of APMP simulated PFI-mill

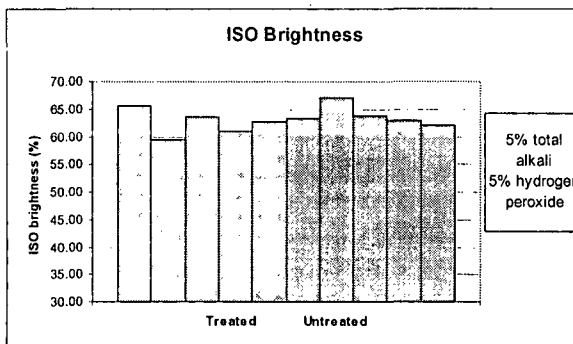
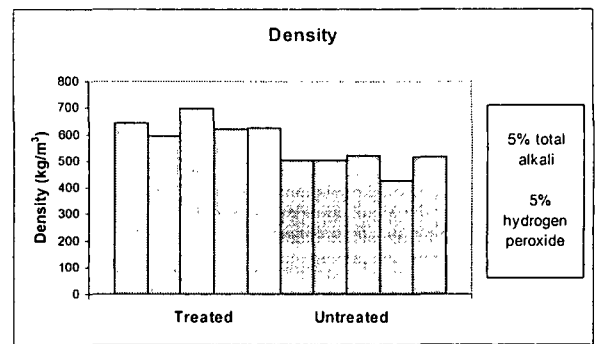
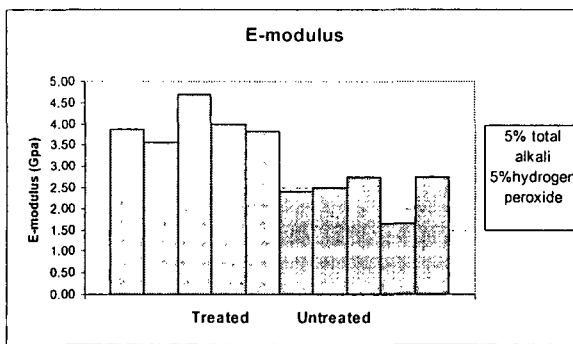
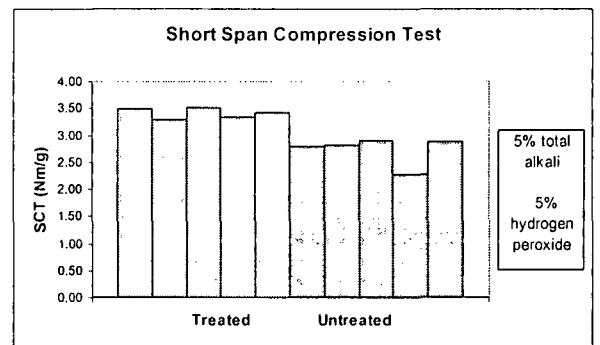
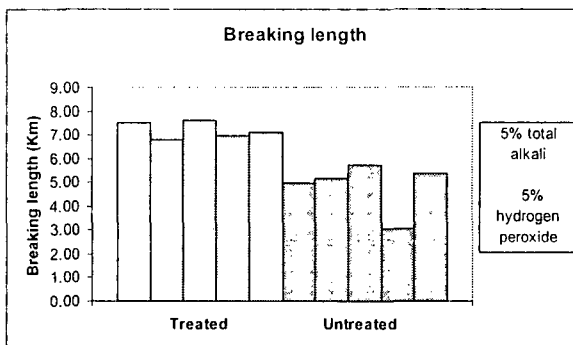
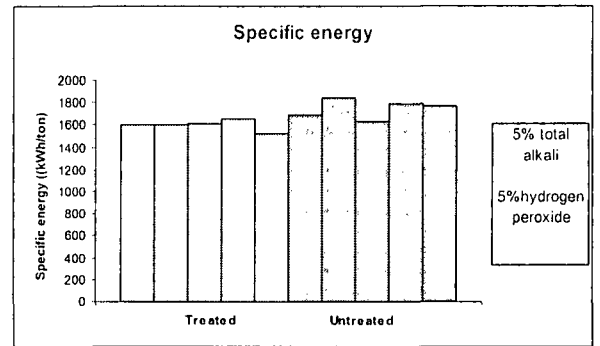
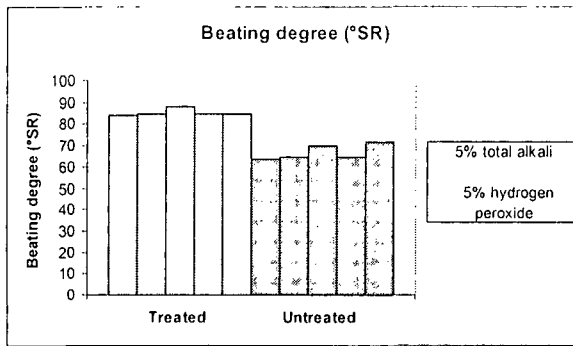

Appendix 9: Graphic presentations of the test results of the second experiment of APMP simulated PFI-mill

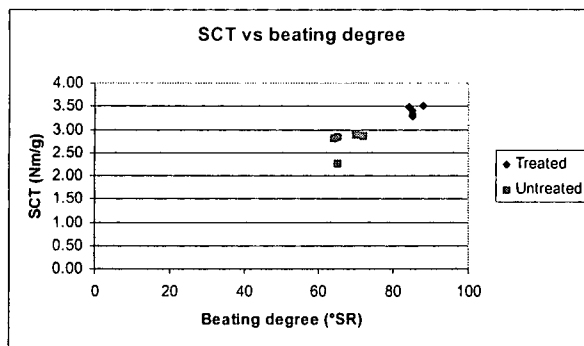
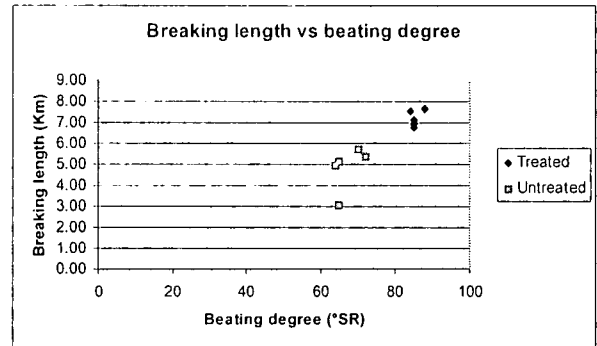
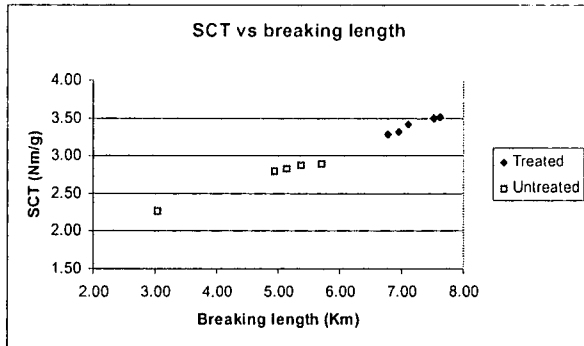

Appendix 10: Handsheet properties

	Run 1 1 stage	Run 1 2nd stage	Run 1 2nd stage	Run 1 2nd stage	Run 1 1 stage	Run 2 1 stage	Run 2 2nd stage	Run 2 2nd stage	Run 2 2nd stage
drainability (° SR)	18	29	60	48	20	46	52	47	
grammage (g/ m ²)	76.8	76.4	75.4	78.8	83.9	80.9	79.7	82.4	
density (kg/ m ³)	320	361	428	387	337	404	427	424	
<i>strength properties</i>									
breaking length (km)	2.05	2.87	3.69	3.18	2.22	3.64	3.99	3.85	
tensile index (Nm/g)	20.1	28.2	36.1	31.2	21.8	35.7	39.1	37.7	
T.E.A.-index (Nm/g)	128	262	322	290	145	360	408	380	
E-modulus (Gpa)	0.9	1.5	2.1	1.7	1.3	2.0	2.2	2.1	
strain (%)	1.0	1.4	1.4	1.4	1.0	1.5	1.6	1.5	
tearing resistance	4.7	5.5	3.8	4.4	6.0	6.0	5.4	5.6	
SCT (Nm/g)	1.7	2.0	2.5	2.2	1.9	2.3	2.5	2.5	
<i>optical properties</i>									
ISO brightness (%)	62.5	63.7	64.1	64.3	61.4	62.6	63.1	63.3	
yellowness (%)	25.1	23.5	22.7	22.7	26.0	24.8	24.8	24.8	
opacity (%)	92.9	94.3	94.5	95.3	94.7	95.7	95.0	95.3	
scattering coefficient (m ² /kg)	45.5	51.3	52.9	54.9	46.7	53.9	52.5	52.4	
absorption (m ² /kg)	1.6	1.7	1.8	1.8	1.7	1.9	1.7	1.7	

Appendix 11 Experimental Procedures

Extruding, refining and bleaching

Raw materials

The Project Leader provided sun-dried jute sticks from the whole stem, harvest Bangladesh 2000. The sticks had an average length of 50 cm. To reduce length, they were processed by a standard woodchipper first. Next, the material was chopped to a length of 6.25 mm by means of a guillotine chopper.

Pre-treatment

The fibres were impregnated with 0.1 M sodium hydroxide with a 1:10 dry fibre : water ratio corresponding to 4% dissolved NaOH on dry matter fibre. The chelating agent DTPA was added at 0.1% on dry fibre weight. The impregnation was done overnight (16 hours) at room temperature.

Before extruder pulping, the liquid was allowed to drain after the impregnation through a perforated screen for 30 minutes. After draining the impregnated fibres were preheated with saturated steam at atmospheric pressure. Before refiner pulping experiments, an additional press stage was necessary to remove unwanted liquid components from the drained pulp.

Extruding

The pulps were extruded in one pass at four to five stages, the bleaching chemicals were injected and mixed with the pulp at the end of the pass. A more detailed description of the used procedures extruding the fibres is given below.

The impregnated, preheated fibre was introduced manually into a modified Cletral BC45 extruder. The pulp mass output was recorded every 30 seconds together with the motor power, thus giving an almost continuously reading of the specific energy consumption of the pulp. Steam was injected into the extruder to supply additional heat to the pulp. At the end of the extruder the bleaching chemicals were injected. Due to the applied screw configuration the chemicals were more or less thoroughly mixed with the pulp.

For all trials the extruder was virtually divided in three successive sections. The first section consists of the inlet of the extruder, transport screws and a reverse screw element (RSE) to defibrate and cut the fibres. In this stage a press action was applied to remove unwanted liquid components from the drained pulp. Upstream of the RSE an outlet for the excess water is placed. The second section consists of a steam inlet, transport screws, an RSE and a filter. The filter is placed upstream from the RSE to remove excess water. The third section consists of transport screws, an inlet for the bleaching chemicals and an RSE or kneading elements to mix the chemicals with the pulp. At the end of the third section self-wiping screws transport the pulp to the outlet of the extruder. The screw configurations were -25H10, -15H8 and -15H12 respectively.

The codes used for the RSE elements are the pitch [mm] of the element, the orientation of the slots (helical) and the slot width [mm]. The kneading element consists of 20 successive rings that are placed off centre on the screw axle. A positive flight as indicated by kneading is created by placing the rings on the axle at different angles. The positive flight significantly reduces the strain between the extruder barrel and the kneading elements.

Refining and bleaching

After the first refining stage all pulps were bleached batch-wise in one step. In all processes the same bleaching chemical composition was used. The chemicals for the bleaching are given below. Before bleaching the pulp was washed twice to remove unwanted liquid components.

Bleaching liquor for the bleaching step

Chemical	% on dry fibre
MgSO ₄	0.1
DTPA	0.05
NaOH	1.4
Silicate	1.0
H ₂ O ₂	2.1

For the regulation of the temperature during the bleaching the following set-up is used:

Bleaching in a closed vessel heated by direct contact with steam

The pulp is put in an open stainless steel vessel, closed with a wooden lid. From the bottom of the vessel, saturated steam is introduced, heating up the pulp in direct contact. Mixing is done both manually and by the motion created by the steam. The temperature of the pulp is about 70 °C. The temperature differences in the pulp are small. The bleaching is stopped with cold water after 1.5 hrs, reducing the reaction rate. The water is drained using a sieve.

Post-treatment

After bleaching the pulps were washed 3 times until pH 8 by adding water up to a consistency of about 5 %. The chemicals were allowed to migrate out of the pulp for some time and the water is drained. Finally the pulps were centrifuged to a dry matter content of about 30% and stored in a freezer.

Determination of the mechanical and optical properties

Hand sheets were formed using a standard sheet former and pressed twice at 4 bar for 5 minutes. The sheets were conditioned and tested at 23 °C with 50% RH. Mechanical and optical measurements were done using ISO standards. For several pulps the properties depending on beating degree were determined.

Enzymatic pre-treatment before hydrogen peroxide bleaching of Extruder Refiner Pulp (XRP)

Pulping

Green jute was treated in an extruder and refiner (XRP) as described in the quarter report 2002-1 (R020306d Table 3). The pulp was processed in the extruder without any chemicals, with a specific energy of 494 kWh/ton. The atmospheric refiner treatment was performed with a plate distance of 0.15 mm and a specific energy of 528 kWh/ton. So the total amount of energy used to prepare this XRP was about 1000 kWh/ton.

Hydrogen peroxide bleaching

The extruded and refined pulp was bleached at different NaOH and H₂O₂ concentrations to find the optimal concentration of chemicals. At the optimum concentration the peroxide bleaching was combined with enzymatic treatments with xylanase and laccase.

The extruded and refined pulp was pre-treated with 0.6% DTPA at 60 °C at a consistency of 1% during 1 hour. After this pre-treatment the pulp was drained and pressed to a consistency of about 50 %

Peroxide bleaching was performed in plastic bags during 90 minutes at a temperature of 70 °C and a consistency of 20%. The addition of 0.2% MgSO₄·7H₂O and 7% Sodium silicate of 39° Bé (S.G. 1.37 kg/l) was the same in each bleaching experiment. The total alkaline concentration was 3 to 5% and hydrogen peroxide was added in concentrations of 3.5 to 6%. Sodium silicate and magnesium sulphate concentrations were high to be sure that maximum brightness is achieved under the chosen hydrogen peroxide and alkali conditions, further optimisation of these chemicals has to be done in an industrial situation.

The enzymatic treated pulps were bleached at total alkaline concentrations of 4 and 5% and a corresponding hydrogen peroxide concentration of 3.5 and 5%. After bleaching the pH of the bleach liquor was measured and a qualitative test on hydrogen peroxide was carried out. The pulp was acidified to a pH of 5 to 5.5.

Enzymatic treatment

Enzymatic treatment was carried out between the DTPA pre-treatment and the hydrogen peroxide bleaching.

Green Jute XRP mechanical pulp with a consistency of 50,3 % was diluted to a consistency of 1,7 % and disintegrated in a phosphate buffer of 25 mM and pH 7.0. The pulp was heated with electric cooking plates, under constantly stirring at 500 rev.min⁻¹, till 50°C. As soon as this temperature was reached, the enzymes were added. The temperature and stirring speed were kept constant. The enzymes Pulpzyme HC (xylanase) and Novozyme 51003 (laccase) were used in concentrations of respectively 50 and 100 Units/gram dry weight of jute. Control pulps were heated and stirred without enzymes. The reaction time for xylanase was 120 min and for laccase 240 min. The recovery of dry weight after xylanase treatment was 90,2 %, after laccase treatment 91,9 %, and for the control 95,2%

After enzymatic treatment the pulp was drained and pressed to a consistency of 45% before bleaching chemicals were added.

Hand sheet properties

After bleaching, the pulp was disintegrated and hand sheets of 160 g/m² were made on a Rapid-Köthe sheet former. The production, conditioning, brightness measurements and strength properties measurements of these hand sheets were all carried out according to ISO standards.

Enzymatic pre-treatment before hydrogen peroxide post-bleaching of Alkaline Peroxide Extruder Pulp (APXP)

Pulping

Green jute was treated in an extruder with bleaching chemicals as described in the quarter report 2002-1 (run 4 Table 2). The amount of energy used to prepare this still very course APXP pulp was about 180 kWh/ton. After the extrusion step the pulp was held for 1.5 hour in a warm water bath to complete the bleaching step.

Enzymatic treatment

Enzymatic treatment was carried out between the DTPA pre-treatment and the hydrogen peroxide bleaching. Green Jute APXP pulp was diluted to 1.7% and disintegrated in a phosphate buffer of 25 mM and pH 7.0. Pulp was heated with electric cooking plates, under constantly stirring, till 50°C. As soon as this temperature was reached, the enzymes were added. The temperature and stirring speed were kept constant. Xylanase (Pulpzyme HC) was used in concentrations of 1, 5, 25 and 50 units/g and laccase (Novozyme 51003) was used at 100 units/g.

After enzymatic treatment the pulp was drained and pressed to a consistency of about 50% before bleaching chemicals were added.

Post bleaching with Hydrogen Peroxide

The APXP pulp was pre-treated with 0.6% DTPA during 1 hour at a temperature of 70 °C. After this pre-treatment the pulp was drained and pressed to a consistency of about 40%

Peroxide bleaching was performed in plastic bags during 90 minutes at a temperature of 70 °C and a consistency of 20%. The addition of 0.2% $\text{MgSO}_4 \cdot 7\text{H}_2\text{O}$ and 7% Sodium silicate of 39° Bé (S.G. 1.37 kg/l) was the same in each bleaching experiment. The peroxide concentration was varied between 1 and 4% and the total alkali concentration was varied between 0.5 and 2%. Sodium silicate and magnesium sulphate concentrations were high to be sure that maximum brightness is achieved under the chosen hydrogen peroxide and alkali conditions, optimisation of these chemicals has to be done in the industrial situation.

The enzymatic treated pulps were bleached at a total alkaline and hydrogen peroxide concentrations of 1%. After bleaching the pH of the bleach liquor was measured and a qualitative test on hydrogen peroxide was carried out. The pulp was acidified to a pH of 5 to 5.5.

Hand sheet properties

After bleaching the pulp was disintegrated and hand sheets of 160 g/m² were made on a Rapid-Köthe sheet former. The production, conditioning, brightness measurements and strength property measurements of these hand sheets were carried out according to ISO standards.

Microbiological pre-treatment before simulated refiner mechanical pulp (RMP) of green jute 1.

Jute chips

Dry green jute was chopped in a wood chipper and subsequently chopped with a guillotine type of chopper adjusted to 6.25 mm. Chips were put in 3-L Erlenmeyers in portions of 220 gram and sterilised (20 min at 121°C) before inoculation.

Micro-organisms

Three selected strains, *Phanerochaete dmyosporium* (2 strains) and *Formis lignosus*, were grown on potato dextrose agar (PDA) for 5 days at 37°C. Subsequently, pieces of agar were transferred to liquid medium (0.3% malt extract, 0.3 % yeast extract and 1% glucose), and the micro-organisms were grown for another 5 days to obtain enough material.

The fungal layers were dispersed into 25 ml of the same medium and carefully re-suspended in a Warning blender. Cells were centrifuged for 5 min at 3000 rpm and the wet weight was determined. Pellet was re-suspended in 10 ml of growing medium. Dry weight was determined on a Whatman cellulose nitrate membrane filter. On the base of the dry weight, a volume with in total 30 mg of micro-organisms was added to 220 g of

jute chips (+/- 193 g dry weight). The dosage of the micro-organisms was thus 30 mg DW per 220 g jute as such, which is comparable with 155 g oven-dry fungus per ton of oven-dry jute.

Subsequently, the inoculated chips were carefully wet with medium up to a moisture content of 66% (medium: 100 mg/L KH_2PO_4 , 200 mg/L NaH_2PO_4 , 450 mg/L MgSO_4 , 100 $\mu\text{g/L}$ FeSO_4 , 20 $\mu\text{g/L}$ CuSO_4 , 10 $\mu\text{g/L}$ ZnSO_4 , 10 $\mu\text{g/L}$ MnSO_4 , 100 $\mu\text{g/L}$ CaCl_2 , 10 μg thiamine-HCl en 20 g/L glucose).

The Erlenmeyers were incubated at 37°C. After the incubation period the Erlenmeyers with the chips were sterilised for laboratory-legislation reasons. So pulp and paper properties of treated and untreated jute were actually determined on two-times sterilised material.

Washing, beating, and pulp and paper properties

After the microbiological treatment the jute was soaked in water at a dry matter content of 5%. Soaking was done during 10 minutes with stirring by hand every 5 minutes. The surplus of water was drained and the soaking started again with fresh water during 20 minutes and stirring by hand every 5 minutes.

Four samples of the treated and washed jute were beaten in a PFI mill during 500 revolutions with a gap of 2 mm and 500 revolutions with a gap of 1 mm. After these two stages of milling the jute was beaten with a gap of 0 mm and the standard pressure of 66.6 N/cm² during several thousands of revolutions. The number of revolutions depended on the reached beating degree. In this way a beating curve of the pulp was made. The beating procedure is a lab-scale simulation of the refiner mechanical pulping process (RMP). The energy needed in the stage with a zero gap was measured. The beating degree was limited to 70 °SR because higher beating degrees would have no practical meaning.

After disintegration during 10.000 revolutions in a standard disintegrator, the beating degree (°SR) of the beaten pulp was measured and hand sheets were made with a Rapid-Köthen sheet former. The hand sheets were tested for grammage, thickness, bulk or density, breaking length, strain, burst strength, short span compression strength (SCT) and brightness at 50% relative humidity (RH) and 23 °C. Beating, making hand sheets and testing were all performed according to ISO-standards.

Microbiological pre-treatment before simulated refiner mechanical pulp (RMP) of green jute 2.

Jute chips

Green jute stems from Bangladesh (harvest 2002) were received in pieces with lengths of around 60 cm. The outer bark of the jute was dark brown. These stems were too long to be processed and had to be shortened. Dry green jute stems were chopped in a wood chipper and subsequently chopped with a guillotine type of chopper adjusted to 6.25 mm. In previous experiments with simulated RMP in a PFI mill the jute appeared to

have too many big parts. Therefore an extra cutting step was carried out in this experiment. The extra cutting was done in a cutting mill with a sieve of 15x15 mm. The dry matter content of the cut fibres was 88.6%

Micro-organisms

Chips were divided into portions of 220 grams and carefully wet with medium up to a moisture content of 66% (medium: 100 mg/L KH_2PO_4 , 200 mg/L NaH_2PO_4 , 450 mg/L MgSO_4 , 100 $\mu\text{g/L}$ FeSO_4 , 20 $\mu\text{g/L}$ CuSO_4 , 10 $\mu\text{g/L}$ ZnSO_4 , 10 $\mu\text{g/L}$ MnSO_4 , 100 $\mu\text{g/L}$ CaCl_2 , 10 μg thiamine-HCl en 20 g/L glucose). The wetted chips were put in 3-L Erlenmeyers and sterilised (20 min at 121°C) before inoculation.

F. lignosus, was grown on potato dextrose agar (PDA) for 5 days at 37°C. Subsequently, pieces of agar were transferred to liquid medium (0.3% malt extract, 0.3 % yeast extract and 1% glucose), and the micro-organisms were grown for another 5 days to obtain enough material.

The fungal layers were dispersed into 25 ml of the same medium and carefully re-suspended in a Waring blender. Five ml of the medium with cells was centrifuged for 5 min at 3000 rpm and the wet weight was determined. Pellet was re-suspended in 5 ml of growing medium. Dry weight was determined on a Whatman cellulose nitrate membrane filter. On the base of the dry weight, a volume with in total 15-mg of micro-organisms was added to 220 g of jute chips (+/- 193 g dry weight). The dosage of the micro-organisms was thus 15 mg DW per 220 g of dry jute chips, which is comparable with 78 g oven-dry fungus per ton of oven dry jute.

The Erlenmeyers were incubated at 37°C during a period of 13 days.

After the incubation period the Erlenmeyers with the chips were sterilised for laboratory-legislation reasons.

Washing, beating and pulp and paper properties

After the fungal treatment the jute was washed and beaten as described above. Pulp and paper properties were analyses also as described before

Microbiological pre-treatment before simulated refiner alkaline peroxide mechanical pulp (APMP) of green jute

Pre-treatment

Green jute was chopped in smaller pieces and subsequently treated with *F. lignosus* as described before, brightened with a hydrogen peroxide bleaching and beaten in a PFI mill. After beating the pulp was analysed and hand sheets were made for evaluation. The size reduction and microbiological treatment was carried out as described in the RMP simulation experiment with an incubation time of 13 days.

In the second set of experiments the shortening and the microbiological pre-treatment were as described before, but a coarse refining step in a 12" refiner was added to the

procedure to create more uniform dimensions of the shortened jute and a more homogeneous mixture of jute bast and core fibre. In this refining step 100 kWh/ton was used.

Brightening

After the fungal pre-treatment the jute was soaked in water at a dry matter content of 5%. Soaking was done during 10 minutes with stirring by hand every 5 minutes. The surplus of water was drained off. The jute was then treated with 0.6% DTPA during 1 hour at 60 °C and 5% consistency. After the DTPA and washing treatment the yield was determined.

The green jute was then bleached with 5% hydrogen peroxide and 5% total alkali in combination with 0.2% Magnesium sulphate and 7% sodium silicate. This bleaching was carried out at 70 °C at 14% consistency during 90 minutes. After bleaching the pulp was diluted to 5% consistency and the pH was corrected to 5-5.5.

To be sure that bleaching would not be hampered, the DTPA and sodium silicate amounts were high. In trials on a more practical scale these amounts can be reduced to a lower and more economic level.

Beating

After the bleaching step the green jute was beaten in a PFI mill

Four samples of the treated and washed jute were beaten in a PFI mill at 10% consistency during 500 revolutions with a gap of 2 mm and 500 revolutions with a gap of 1 mm. After these two stages the jute was beaten with a gap of 0 mm and the standard pressure of 3.33 N/mm bar length (66.6 N/cm²) during respectively 6000, 9000, 10500, 12000 and 15000 revolutions. In this way a beating curve of the pulp was made. The beating procedure is a lab scale simulation of the refiner mechanical pulping process (RMP). The energy needed in the stage with a zero gap was measured. The beating degree was limited to about 70 °SR because higher beating degrees would have no practical meaning. After disintegration during 10.000 revolutions in a standard disintegrator, the beating degree (°SR) of the beaten pulp was measured.

Evaluation of hand sheets

After disintegration hand sheets were made with a Rapid-Köthen sheet former. The hand sheets were tested for grammage, thickness, bulk or density, breaking length, strain, short span compression strength (SCT) and brightness at 50% relative humidity (RH) and 23 °C. Beating, hand sheets making and testing were all performed according to the ISO-standards.

Production of APMP pulps on a 12"inch refiner

Material and methods

The material used was from the first received batch of green jute. The jute was chipped in a wood chipper and subsequently cut in a cutting mill (Pallmann) equipped with a sieve of 15 x 15 mm. These particles are further reduced in size by a pressing step as described below. In the laboratory experiments this further reduction in size was found beneficial for the bleaching step.

Pre-treatment

The jute was soaked in hot water of 70 °C for half an hour. After soaking the surplus of water was drained. This soaking treatment was repeated once and subsequently the jute was soaked with water of 70 °C and 0.6 % of DTPA on dry matter for one night (about 16 hours) in an isolated vessel and drained again. After draining the jute was pressed in the Multiple screw device (MSD) of the refiner to a dry matter content of about 50 %. The jute was further reduced in size by this pressing action. This will also happen when production is on an industrial scale, in that case chips are always fed to a refiner with this kind of equipment.

Bleaching and first stage refining

The chemicals were added and mixed before refining. On dry mass 0.2% of $\text{MgSO}_4 \cdot 7\text{H}_2\text{O}$, 7% of Sodium silicate solution of 38 Bé (s.g.(1.37) , 5% total alkali and 5% of H_2O_2 was added. The chemicals were added after solution in warm water and mixed by hand and in a ribbon mixer for one minute. The consistency was 20%. The jute was then added to the pre-heated storage bin of the refiner and steamed at atmospheric pressure for 10 minutes. Refining was carried out with refiner plates of type D2A505 NH and at a plate gap of 0.2 mm. The refining temperature was 128 and 131 °C and the average residence time at this temperature was 14 minutes. After refining the pulp was held in an isolated vessel for another hour at 70°C.

Washing

The bleached and refined pulp was washed three times with cold water at a consistency of about 7% in the above-mentioned vessel. After diluting to this consistency with cold water, the pulp was stirred by hand and after a residence time of 15 minutes the diluted pulp was drained. This procedure was repeated three times. The pulp was then squeezed to a consistency of about 15%.

Atmospheric refining

A second stage of refining of the pulp was applied under atmospheric conditions. The applied plate distance was 0.15, 0.1 and 0.75 mm. The refining temperature varied between 37 and 55 °C and the consistency was between 2.5 and 3%.

Making of hand sheets

60 grams of pulp was disintegrated during 10,000 revolutions. For latency release the pulp was first disintegrated in hot water during 5000 revolutions. After 45 minutes of residence time another 5000 revolutions of disintegration were carried out. Hand sheets were made of the first and second stage pulps.