



TOGETHER
for a sustainable future

OCCASION

This publication has been made available to the public on the occasion of the 50th anniversary of the United Nations Industrial Development Organisation.



TOGETHER
for a sustainable future

DISCLAIMER

This document has been produced without formal United Nations editing. The designations employed and the presentation of the material in this document do not imply the expression of any opinion whatsoever on the part of the Secretariat of the United Nations Industrial Development Organization (UNIDO) concerning the legal status of any country, territory, city or area or of its authorities, or concerning the delimitation of its frontiers or boundaries, or its economic system or degree of development. Designations such as “developed”, “industrialized” and “developing” are intended for statistical convenience and do not necessarily express a judgment about the stage reached by a particular country or area in the development process. Mention of firm names or commercial products does not constitute an endorsement by UNIDO.

FAIR USE POLICY

Any part of this publication may be quoted and referenced for educational and research purposes without additional permission from UNIDO. However, those who make use of quoting and referencing this publication are requested to follow the Fair Use Policy of giving due credit to UNIDO.

CONTACT

Please contact publications@unido.org for further information concerning UNIDO publications.

For more information about UNIDO, please visit us at www.unido.org

22943

AFRICA FOREIGN INVESTOR SURVEY 2003

Motivations, operations, perceptions and future plans
Implications for investment promotion

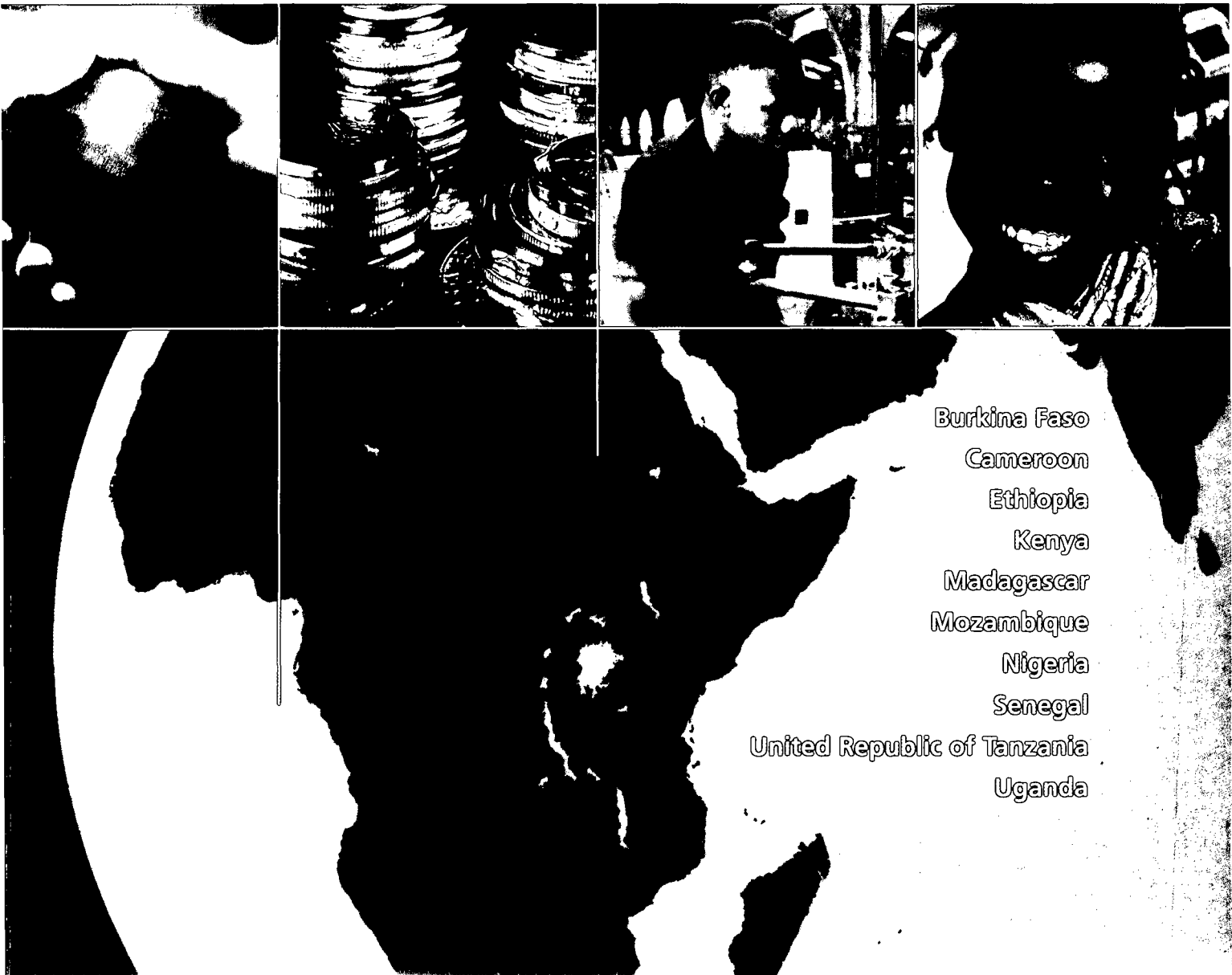

Burkina Faso

Cameroon

Ethiopia

Kenya

Madagascar

Mozambique

Nigeria

Senegal

United Republic of Tanzania

Uganda



UNITED NATIONS INDUSTRIAL DEVELOPMENT ORGANIZATION

economy environment employment

AFRICA Foreign Investor Survey 2003:
Motivations, Operations, Perceptions
and Future plans –
Implications for Investment Promotion

Burkina Faso
Cameroon
Ethiopia
Kenya
Madagascar
Mozambique
Nigeria
Senegal
Tanzania, United Republic of
Uganda



UNITED NATIONS INDUSTRIAL DEVELOPMENT ORGANIZATION
Vienna, 2003

The designations employed and the presentation of material in this publication do not imply the expression of any opinion whatsoever on the part of the Secretariat of the United Nations Industrial Development Organization concerning the legal status of any country, territory, city or area, or of its authorities, or concerning the delimitation of its frontiers or boundaries. The opinions, figures and estimates set forth are the responsibility of the authors and should not necessarily be considered as reflecting the views or carrying endorsement of UNIDO. The designations "developed" and "developing" economies are intended for statistical convenience and do not necessarily express a judgement about the stage reached by a particular country or area in the development process. Mention of firm names or commercial products does not imply endorsement by UNIDO.

This publication has not been formally edited.

Acknowledgements

The AFRICA *Foreign Investor Survey 2003* was prepared by the Industrial Promotion and Technology Branch of the Programme Development and Technical Cooperation Division (PTC/IPT) under the guidance of its Director, Mrs. Dan Liang, as part of the Branch publication series. It was financed through a contribution from the Multilateral Development Cooperation of the Government of Austria. Mr. Mithat Külür, Industrial Development Officer, PTC/IPT was responsible for the overall programme development and coordination and in completing the report was supported by Mr. Frank Bartels and Mr. Patrick Gilabert with technical contributions from Mr. Thiam Hee Ng and Ms. Müge Dolun. Special thanks also to UNIDO intern Mr. Sadiq Alladina.

The surveys in the participating countries were conducted with the assistance of national consultants.

Mr. Wim Douw and Ms. Katrien De Marez of Plant Location International, IBM provided valuable support in questionnaire design, data entry, analysis and drafting.

The primary purpose of the survey is to provide inputs to the UNIDO-Africa Investment Promotion Agency Network (AfrIPANet) in formulating promotion strategies in the member countries. This report presents the overall findings and first impressions. The data will be analyzed in more depth to study specific issues and presented in subsequent UNIDO working papers.

Foreword

International investment in general and foreign direct investment (FDI) in particular is perceived as indispensable for the growth of developing countries in view of its multiple impact. Foreign capital inflows are expected to enhance skills and know-how, improve efficiency in the use of resources, accelerate growth through capital accumulation and enhance trade. However, attracting FDI has proven to be a major challenge as the competition between developing countries intensifies and the barriers to entry into global production networks prove difficult to surmount.

While economic orthodoxy provides the ingredients for sound growth policies, including the attraction of FDI, the development trajectory of many countries has shown that the success stories are mostly derived from context-specific solutions. Such solutions, orthodox or otherwise, must be tailored to particular circumstances of the concerned country. These realities dispel the straightforward use of recipes based on conventional economics or the simple transplant of successful experiences from one country into another and highlight the need for in depth analysis at the country and industrial sub-sector levels.

Having in mind the mandate and responsibilities of UNIDO in what concerns the promotion of FDI to developing countries in general and to African countries in particular, the above picture suggests an analysis of what determines the motivations and options for Transnational Corporations (TNCs) when targeting developing countries. By the same token, it is useful to analyse the relevant aspects of market imperfections and government failures that policy makers have to address in order to attract investors, provide the necessary public goods and articulate the instruments that stimulate and sustain growth.

This survey is a follow-up to an initiative launched in 2001 for assisting African investment promotion agencies in designing country specific strategies. The data and subsequent analyses will contribute to a better understanding of how to match national efforts for attracting FDI with investor motivations and decision criteria. It will also provide sufficient detail to assess the effects of different kinds of FDI and different groups of investors on the economy of specific countries.

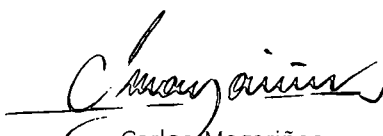

Carlos Magariños
Director-General, UNIDO

CONTENTS

Foreword	v
Executive summary	ix
Introduction	1
1. The survey methodology	5
Data collection method and timetable	5
Selecting the sample	5
Target population and target respondents	6
Sample size	6
Procedure for selecting companies for the sample	7
Questions and layout of the questionnaire	7
Coding, data entry and checking data entry	8
2. Analysis of survey respondents: A profile of who is investing in sub-Saharan Africa	9
Number of respondents per country	9
Sector coverage	10
Origin of respondents	13
Respondents by year of establishment	14
Respondents by main business activity	17
Entry mode	20
Company size	22
Market orientation of investors	25
3. Investor motivation and important respondent categories	27
4. Investors' performance and future outlook	33
Investors' experience in each country	33
Future outlook	36
5. Perceptions and service needs of investors	43
Pre-investment and investment	43
Post-investment	59
6. Economic impact of foreign investors	61
Manufacturing value added	61
Local sourcing of inputs	63
Local business links	63

7. Survey implications for IPAs and other actors in FDI promotion	65
Survey implications for IPAs in the countries surveyed	65
Survey implications for national governments	69
Implications for development agencies	71
8. Indices to watch	73
Country FDI environment performance indicators	73
9. The impact of international trade agreements on FDI in sub-Saharan Africa: the case of AGOA and EBA	81
Introduction	81
Survey results	82
Conclusions	83
<i>Annex I: Questionnaire</i>	85
<i>Annex II: Sector categories</i>	89
<i>Annex III: Technology intensity of manufacturers</i>	91
<i>Annex IV: Tables</i>	93

Executive summary

Introduction

National policies and international investment agreements are important framework conditions for increasing the flow of investments to developing countries and for realizing their benefits in the host country. However, foreign direct investment (FDI) and the benefits of FDI do not accumulate automatically and evenly among continents and countries. The share of Africa in global FDI is less than 2%, which is far below its fair share when considering the size of the continents' population. Nonetheless, FDI inflows to Africa as a whole and the sub-Saharan countries in particular show a rather steady trend line albeit at a disproportionately low level.

Various international development agencies are heavily involved in Africa with policy advice and different technical assistance programmes to maximize the opportunities for attracting FDI to these countries. These programmes mainly aim at enhancing the basic investment climate conditions – a condition *sine qua non* for investment by both foreign and domestic companies – and enhancing capacity and efficiency at government agencies dealing with these investors. Attracted by other successful examples overseas and by the expected benefits that would follow, most sub-Saharan countries are now seriously committed to improving investment climate conditions and achieving a transparent and enabling policy environment for FDI. In most cases however, this commitment has yet to translate into required reforms of existing economic structures, removal of unnecessary regulations and improvement in the efficiency of public administrations.

Many have also accepted the advice that they should more actively “market” themselves to the international investment community through implementation of dedicated investment promotion structures. Most countries in sub-Saharan Africa have now created Investment Promotion Agencies (IPAs) to provide services to potential and existing foreign investors and remove (or advocate the removal of) obstacles facing inward FDI.

Despite some success stories, these efforts by themselves have not succeeded in dramatically changing the FDI landscape.

Limitations in resources and finances available to these agencies make it impossible to emulate the “best practices” in organization and implementation of investment promotion found among the leading IPAs in Europe. In the short term, the challenge for sub-Saharan IPAs is to employ low-cost but effective investment promotion strategies within the given budget and resource limitations to achieve quick-wins and success stories. In the medium term the key challenge is to demonstrate the potential utility of these agencies to policy makers thereby increasing financial resource allocations to IPAs from national budgets. Increased resources would lead to enhanced capabilities and a gradual switch over to implementation of global best practices in investment promotion.

Such development, if it could be readily achieved, would undoubtedly enable African IPAs to adopt a more professional approach and probably achieve greater success in attracting FDI. To support this challenge is the ultimate objective of the present UNIDO Investor Survey.

Survey background

This survey was launched in the context of an initiative to bring continuity to partnerships between UNIDO and sub-Saharan IPAs with which UNIDO has an active technical assistance programme. This initiative established a forum for bringing together the member IPAs on a regular basis to discuss issues of common concern, to explore new initiatives that would increase the effectiveness of African IPAs and to maintain a permanent programme of training and capacity building. The UNIDO-Africa Investment Promotion Agency Network¹ (AfrIPANet) was launched in Vienna on 20-23 November 2001.

For the inaugural meeting of the Network, a pilot survey of foreign investors was conducted to provide inputs to the discussions regarding what kinds of investors come to sub-Saharan Africa, what their expectations were, what their experiences have been and what their predictions regarding growth and future investment are. The results of this pilot survey covering Ethiopia, Nigeria, Uganda, and the United Republic of Tanzania entitled "Foreign Direct Investor Perceptions in sub-Saharan Africa" were summarized for presentation and possible uses of

the information for developing promotion activities were discussed. The member IPAs² unanimously recommended that the survey should be conducted for all member countries on a regular basis. Broadening the scope of the study would provide high quality information on the factors that currently facilitate and encourage FDI flows (as well as those that constrain and discourage it) to the region and allow the IPAs to design more focused strategies.

The main objective is to develop a better understanding of issues on the supply side (country investment conditions) and demand side (foreign investor motivations and needs) and the role of governments and international development agencies in facilitating the process of supply meeting demand.

Various organizations and academic institutions have contributed over the years to developing a better understanding of FDI in Africa. This survey intends to complement these existing insights and views on FDI in Africa by providing a very comprehensive picture of existing foreign investors for 10 countries in the region. Some important findings of this survey have been translated directly into lessons and actions for local governments and IPAs in the countries surveyed, and more in-depth analysis of specific issues using the data will be conducted and published by UNIDO subsequently.

The survey was designed to assist national IPAs to improve their effectiveness and provide information that could benefit a wider audience. Moreover, the information obtained would directly assist the future work of AfrIPANet and UNIDO in enhancing capacity at sub-Saharan IPAs. It is anticipated that the survey will be repeated every two years, covering all member countries and feeding both time series and cross-sector data. The survey consists of a fixed set of questions for profiling foreign investors who have invested in sub-Saharan Africa as well as their motivations and expectations.

In addition, information will be extracted to:

- Assist in the identification of the subsectors of growing interest for foreign investors, as well as determine the characteristics of potentially important investor sub-groups like major exporters, companies with expectations of high growth and new

¹ The Network is comprised of Investment Promotion Agencies (IPAs) from sub-Saharan African countries with ongoing UNIDO integrated programmes (IPs), UNIDO Investment and Technology Promotion Offices (ITPOs) and an Advisory Panel from the private-sector. The current 15 member countries of the Network include: Burkina Faso, Cameroon, Ethiopia, Ghana, Guinea, Kenya, Madagascar, Malawi, Namibia, Nigeria, Senegal, United Republic of Tanzania, Uganda, and Mozambique.

This initiative represents an amalgamation of the investment components of the integrated programmes and its membership will expand with the initiation of new integrated programmes. The Network also functions as a resource group of IPAs who have been working with UNIDO and can provide guidance in the design of UNIDO's country-level programmes. It is also a permanent platform for training, capacity-building and continuous linkage to UNIDO's worldwide network of Investment and Technology Promotion Offices (ITPOs).

² The 11 founding members of AfrIPA Net are: Burkina Faso, Cameroon, Ethiopia, Ghana, Guinea, Madagascar, Mozambique, Nigeria, Senegal, Uganda, and United Republic of Tanzania.

investments, operations with high local content, etc.

- Give an indication of the trends in FDI inflows.
- Determine which IPA services and government interventions are most valued by existing foreign investors and what additional support and incentives would facilitate new investment;
- Reveal which aspects of the country (cost structures, markets, resources, etc.) are the most important determining factors influencing the decisions of foreign investors;
- Provide empirical data on stated plans of foreign investors in the member countries that indicate the potential flow of new investment from existing operations. This could eventually yield a forward-looking macro indicator of future investment flows to the region and indicate the most attractive subsectors for future investment;
- Provide a ranking of the UNIDO integrated programmes (IP) countries in terms of the different components of foreign investor perceptions.

The survey, when repeated over time, would also provide information at the level of IPAs on the strategies and techniques that succeed in an African context. It would also be possible to develop output indicators and ratings for individual IPAs that would enable a ranking of their performance and thus influence the attitudes of their governments, their business communities and their client base. They would also provide information that would guide development assistance and donor programmes.

This survey therefore represents the start of a unique, in-depth and ongoing FDI monitoring process in sub-Saharan Africa. It will enable African countries to continuously monitor, evaluate and improve their investment promotion performance, leading to enhancement of supply side conditions according to private-sector needs. Fulfilling these conditions would increase the regions attractiveness to foreign investors and hopefully change the present inequitable and meagre share of FDI to this region. African governments will have to take

responsibility in terms of creating an investment climate that allows the private-sector to do business and be profitable. Equally, governments in developed countries have the responsibility to make trade and investment work for poverty reduction in developing countries by removing remaining obstacles. The results were summarized for presentation at the second UNIDO — Africa Investment Promotion Agency (IPA) Network Seminar (AfrIPANet II) on 2-5 December 2003 in Vienna.

Survey results

An important factor that determines the reliability of the results of a survey like this one, where the perceptions of the individual filling in the questionnaire are being tabulated and analyzed, is the decision making position of that individual in the company. Of the respondents, 90% were senior line managers, including 46% that were chairmen, managing-directors, directors or owners and 43% that were financial or other senior managers.

The total number of valid respondents to the survey was 758 enterprises with more than 30% foreign capital. The survey focus is on manufacturing operations of foreign companies³. Various non-manufacturing sectors were excluded from the survey, in particular mining and small-scale services and retailing.

The survey first focused on putting together a clear picture of the existing foreign investors in the survey countries in terms of sector, origin, year of entry, entry mode, main business activity, company size, market orientation, etc.

Sectors

The survey found that over 60% of foreign investors in the region are concentrated in 8 key sector categories. These sectors are: food and drink (16%), other chemical products (including paint, soap and detergents (10%), agriculture and tobacco (8%), wearing apparel (6%) and wood, pulp and paper products, metal products, machinery and financial intermediation (each 5%).

³ All future references to foreign companies in the survey refer to companies with at least 30% foreign capital.

As expected, the majority of foreign investments in sub-Saharan Africa (82%) were in resource-based or low-technology sectors.

Recent sector mobility was found in 5 of the 8 key sectors, particularly wearing apparel. This sector was followed by agribusiness, food and drink, other chemical products, and machinery, which show recent inward FDI activity. The study found that the inflow of large export-oriented investors in sub-Saharan Africa has accelerated considerably in recent years and shows a strong upward trend. One third of all export-oriented companies was established in the region after 2000. In particular, foreign firms in the wearing apparel sector taking advantage of African Growth and Opportunity Act (AGOA) contribute to this trend. In the period since 2000, the wearing apparel sector has taken over the number one spot from the food and drink sector as being the most important in terms of new investment projects in the region.

Combining several of the survey findings led to the conclusion that wearing apparel and agribusiness are especially important sectors for sub-Saharan Africa. They show inward investment mobility, create a larger number of jobs and contribute more than other sectors to country exports.

Origin of investment

European Union (EU) companies occupy the number one spot as the origin of FDI in the target countries (40% of survey population) followed by African companies that are the second most important group of investors in sub-Saharan Africa, both in terms of number of projects and amount of capital invested. Companies from South Africa are the source of one-third of all these African investments. In total, 75% of all foreign investments in the survey region have come from these two source regions. Striking is the fact that two large global economies, the United States and Japan, are the most important absentees among the foreign investor population in Africa. This is in contrast to the position of both countries as leading foreign investors elsewhere around the world.

Trend indications show that EU is becoming relatively less important as a source of new investments,

whereas Asia is strongly emerging as a new source region for FDI. Asian investors do have a relatively strong presence in a few very specific sectors such as wearing apparel and other chemical products (including rubber and plastic products). Although EU companies are making less greenfield investments in the region, they remain a major source of new greenfield FDI projects and a major investor in terms of expansion of existing operations.

Size of investment

The average investor in sub-Saharan Africa is relatively small in size. Small companies and medium sized companies dominate most sectors. Exceptions are the agribusiness and wearing apparel sectors where a large proportion of the companies are large companies with more than 250 employees.

Overall, 37% of the respondents had a current investment value below US\$ 1 million. One-quarter of the respondents had an investment value of US\$ 10 million or more. Particularly companies from the non-metallic mineral products and basic metals sectors fell in this category.

Entry mode

Nearly 60% of all foreign investors entering the sub-Saharan region have done so through a greenfield investment. Greenfield entry was the dominant entry mode in all sectors except pharmaceuticals. With an overall share of 25% of all investments in the region, joint ventures are the second most common form of entry employed by existing foreign investors.

Market orientation

The survey found a strong orientation towards serving the domestic and to a lesser extent regional markets, and a small but rapidly growing contingent of export-oriented investors serving continental markets. Looking at some of the regional trade agreements, a sizeable portion of respondents either take advantage of them or find them an important parameter for their business.

Only two sectors stood out with a large share of the companies exporting over 75% of annual sales:

agribusiness and wearing apparel. These exports were mainly for the United States and European market. Other sectors, showing less export intensity, were mainly focused on serving other African countries as an export market.

Investor motivation and perceptions

In addition to profiling the typical investors coming to Africa, the survey also explored the motivations of these investors for coming to the region in the first place. The large number of recently arrived investors in the survey population has contributed to the quality of the survey results in terms of identifying investor's motives for coming to the host country and the decision process that led to the choice. Representatives of companies that have been in the region for a long time may not know the original rationale and decision process.

The survey results confirm the well-known pattern of predominantly market driven and resource-based investments going into Africa. Overall, in terms of market focus, the local market was considered most important followed by the regional market, which appeared much less important. Overseas markets were considered least important.

An important deviation from this pattern is the new inflow of export-oriented investments in Africa that want to take advantage of trade agreements. In particular, AGOA is generating a considerable and growing inflow of FDI that would not otherwise come to Africa without the existence of this agreement. Since this is a recent phenomenon, little can be said about the sustainability and long-term potential of these investors. Future surveys will certainly pay close attention to monitoring the impact of AGOA and EBA in terms of FDI inflows in the region.

In addition to understanding the key drivers for foreign investment in sub-Saharan Africa, the survey also focused on understanding the criteria foreign investors use to determine the final country location for their investment. For both governments and IPAs, it is important to fully understand the factors that can attract or deter foreign investors to a particular location.

Contrary to the situation in the more developed economies like Europe, foreign investors in sub-

Saharan Africa put a very strong emphasis on general business climate conditions. Political stability and economic stability were the most important factors to foreign investors in their country evaluation. These were followed by five other important considerations: country legal framework, investment climate transparency, quality of infrastructure, low labour cost and skilled labour availability.

Factors such as local incentive package and availability of local suppliers or raw materials, government agency support services and quality of life were only of secondary importance overall, although this could vary between the sectors and different subgroups of foreign investors surveyed. In general, large exporters, for example, put more emphasis on resource availability and cost issues.

Analysis showed that there is particularly strong competition for an investment project between neighbouring countries. About 30% of the foreign investors in the survey were evaluating more than one country location and looking at critical location factors before their establishment in the current location. Large export-oriented companies sometimes indicated that other country locations outside Africa were considered as potential alternatives.

The survey also confirmed a key finding from the pilot survey that private-sector contacts are the most important source for potential investors in terms of creating awareness of investment opportunities in a country. Two-thirds of the foreign investors indicated that they were made aware of the investment opportunity through business related contacts, including one-third indicating existing investors in the country as the main source.

Direct contact by the IPA created awareness about the opportunities only for 10% of all the respondents. This was an important finding and very useful in terms of the objective of this study: developing effective but low-cost investment promotion strategies.

Valued IPA services and IPA performance

The survey also identified the services investors would like to receive from investment promotion agencies during the investment decision-making

process and to facilitate the investment implementation after a decision has been taken.

Registration of investors would appear to be the most significant service provided by the IPAs in Ethiopia, Madagascar, Uganda and the United Republic of Tanzania. In all other countries surveyed, investor registration was a much less common IPA activity.

Another interesting finding is that more than 85% of the companies that did register with the IPA, also requested other IPA services. This compared to only 25% of the companies that did not register with the IPA. This seems to indicate at least a functional role for the registration process in bringing the IPA into early contact with investors and increasing the supply of services. Until better structures for bringing potential investors into early contact with the IPAs are in place, this may be a practical alternative.

Generally speaking, over 90% of the companies that did register with their respective IPAs rated the process as being good to excellent. Nearly half of this group found the registration process extremely useful in obtaining taxation and other benefits.

This finding has important implications for the role of IPAs in the registration process. It proves that investors in countries where the IPA is less involved in registration are likely to obtain fewer other benefits and support from the host country.

Another interesting finding was that out of the 10% investors that were made aware of the investment opportunities in the country by the IPA, more than 90% requested additional services from the IPA in the pre- and post investment stage. Both findings

seem to suggest that investors are willing to work with the IPA and use its services but are often unaware of the existence of an IPA or its support services.

Investors normally seek the assistance of national IPAs on issues other than certification. The survey asked a wide range of questions on these other issues and encouraged investors to indicate the services they themselves sought from IPAs.

Pre-investment services requested by more than 75% of the foreign investors were:

- Information on taxation and incentives
- Information on doing business in the country (includes information on required permits and procedures, labor regulations, etc.)
- Information on investment climate conditions (includes e.g. political and economic stability, legal framework, etc.)
- Information on costs of doing business in the country (including labour costs, property costs, utility costs, etc.)
- Information on import/export regulations and tariffs

Overall the organization of a fact finding trip and the introduction to potential partners were considered least important by foreign investors.

Post-investment services that were important to more than 75% of the foreign investors to facilitate their investment implementation included:

- Company registration and licensing
- Obtaining permits
- Incentive applications

Figure A. Evaluation of importance versus quality of services investors did request or use from IPAs in the pre-investment phase

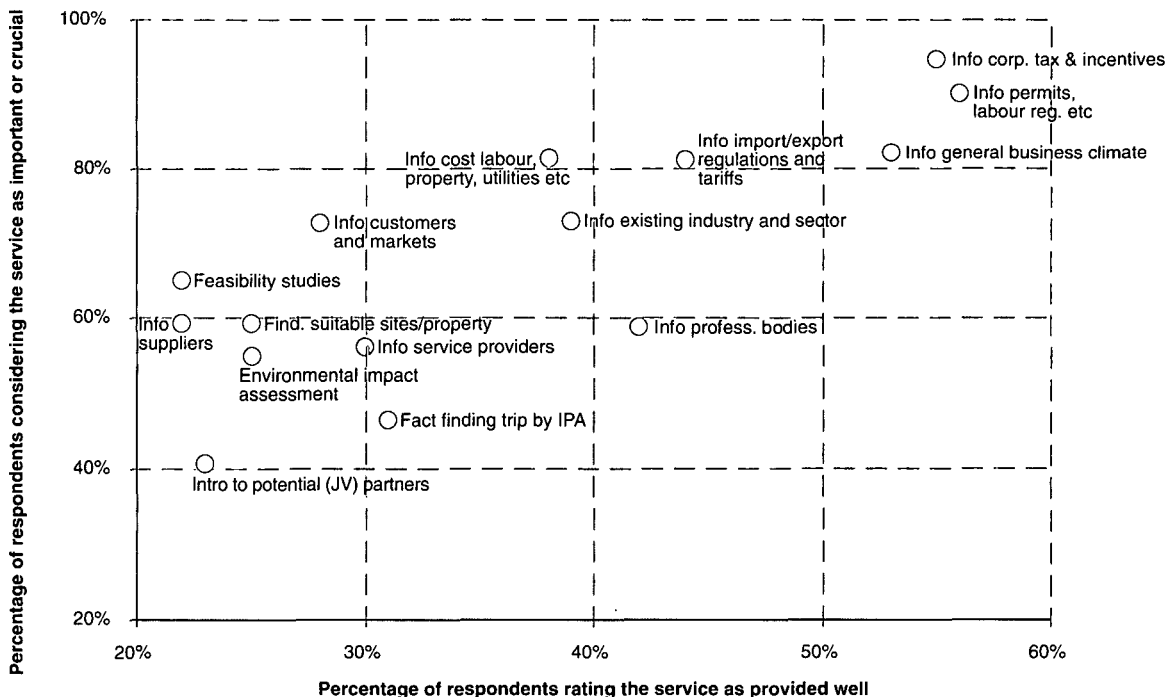
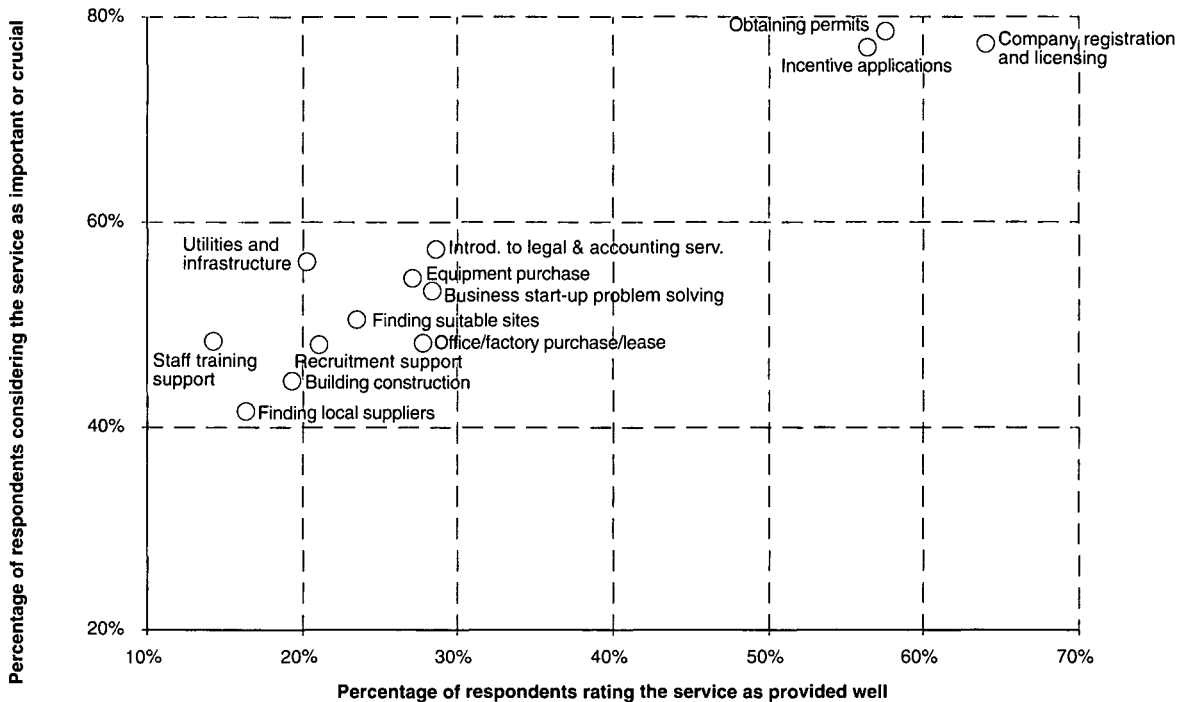

Figure B. Evaluation of importance versus quality of services investors did request or use from IPAs to facilitate their investment in the host country



The study found that pre- and post investment services most important to foreign investors were provided best by the IPAs. However, a large group of foreign investors still found these and other services not provided or not provided well. This points to the need for the expansion of IPA services to foreign investors as well as the enhancement of the quality of the services provided.

The study found that incentives most desired by foreign investors were the ones most difficult to obtain. Incentives were considered an important location factor by about half of the foreign investor population. Incentives most desired by foreign investors were duty exemptions and taxation reduction.

Foreign investors provided very positive feedback on how they felt important business climate conditions in their location have changed since they established in the country. Overall, the picture for the region showed that foreign investors found all important location decision making factors had mostly developed in a positive direction. Particularly factors such as political stability, local suppliers, skilled labour availability and local market conditions have generally improved. Economic stability, one of the most important factors in location selection, was mentioned most frequently as having deteriorated.

Investor performance in relation to expectations, an important indicator on future investment prospects, revealed that 60% of the investors found that their investment had performed in line with or above expectations. Country specific analysis revealed that especially in Burkina Faso and Senegal a large share of the investments performed in line with or above expectations.

Favourable market conditions were the primary factors responsible for positive evaluations of the investment performance according to the investors. This is not surprising given that a majority of the investors' motivation and orientation is local market seeking as described earlier. Other positive influences included labour costs being less than expected. Among the main factors negatively influencing investment performance were: market developments, political and economic instability, transport and infrastructure issues, and taxation issues.

Sectors with more than 50% of the investments performing below expectations are textiles, wearing

apparel, pharmaceuticals and transport equipment. This is very significant since these are some of the most export intensive, high employment generating or high technology content sectors. This leaves individual countries with an important task to identify and address the issues causing these investments to underperform in sub-Saharan Africa. Sectors performing particularly well in sub-Saharan Africa are agriculture, basic metals, base chemicals and financial intermediation.

Economic impact and future outlook

It is not only important for countries to attract FDI, but equally important to make sure that potential positive externalities materialise in the country. One of the areas the survey looked at was the local sourcing of inputs. Overall local sourcing of inputs was relatively low with nearly 30% of the investors indicating that less than 10% of the total value of the final product was sourced locally and two-thirds saying that less than 50% was sourced locally.

A relatively high percentage of the large export-oriented firms were sourcing more than 75% of their final product value locally. Particularly agriculture (obvious) and food and drink companies were in this category. Large export-oriented firms in the wearing apparel sector, however, are still sourcing most of their inputs elsewhere. Since this sector is growing fast in terms of inward FDI, there seems a potential to be leveraged by local IPAs in terms of introducing these companies to local supply opportunities. The results of this survey and other existing research suggest that over time companies tend to develop more local input linkages.

Other local business links of foreign investors mainly consists of contacts with the chamber of commerce and local sector or industry organisations. Links with universities, research institutes and academic institutes were mainly developed by resource-based industries, such as the agriculture sector.

The survey findings in this area will help IPAs in defining after-care targets and potential linkages to be established between different categories of new investors and the host country.

On average the future growth outlook of respondents was quite positive. Around 80% of the companies expected sales to grow and more than 50% of the companies expected employment growth over the next three years. A relatively large proportion of the large exporters anticipated global sales to grow by more than 20% annually. This seems to indicate that even though many exporters have performed below their original expectations, they are optimistic about future growth. The agriculture sector will be the most important job creator among key sectors of existing investors.

The survey tracked future investment plans by asking the investors their preferred location for future investment. Only half of the investors responding to the question were satisfied with their existing location, whereas the other half would prefer another country location. The commitment to current location was highest in Mozambique and lowest in Madagascar. Other countries mentioned were neighbouring locations in most cases. Overall, South Africa was by far the most preferred alternative location option.

This is a finding of great importance. As shown in the report, existing investors play a critical role in encouraging new investors in making decisions on new investment locations.

The survey asked investors to indicate the future levels of investment planned over the next three years in their existing location (in addition to depreciation or replacement investments). More than 75% of the investors were planning a new investment. Across the 10 countries, existing investors planned investments worth between US\$ 1.6-3.1 billion over the next three years. This amount corresponds to the annual average of inward FDI for the 10 countries based on official inward FDI statistics. Total FDI inflow in the survey countries could be significantly higher since these figures do not include potential investments from other current foreign operations not covered by the survey or new investors.

Performance in the past appeared to be a good indicator for future investment and growth expectations. Respondents with an investment that has performed above expectations are more likely to invest more and create more new jobs compared to investors that evaluate their recent investment performance

less positive. This is a finding of great importance. Not only are these investors of great importance to the country in terms of new capital investments and jobs, but as shown before, happy investors are also an important channel for creating positive awareness about the investment opportunities in the country. This has important implications for the priority and depth of the relationship IPAs need to establish with these investors.

A significant feature of the survey is that it is able to produce data on investor intentions on an individual firm basis. This is of importance from the point of view of national IPAs. As will be pointed out later, it enables them to focus promotion efforts on the identified leading firms and sub-sectors. This is a relatively inexpensive but a most effective way to focus promotion resources for maximum efficiency.

Implications and key conclusions of the survey

IPAs

The survey provides empirical evidence to assist IPA boards and chief executives to convince policy makers about the imperative to give more attention and resources to maintaining a satisfied base of existing foreign investors. IPAs need to develop strategies and structures to build and nurture excellent relationships with the existing FDI community and affiliate organizations such as chambers of commerce, industry bodies and academic and training institutions. All the indicators emerging from the survey point to the fact that IPAs would greatly improve their immediate effectiveness if they pursued this course of action.

The data regarding the future investment intentions of existing foreign investors in each country presents an ideal starting point for this exercise. Providing whatever assistance they can within their authority would be an ideal way for IPAs to construct a mutually beneficial relationship with existing investors and unlock this potential. The data can also be used by the IPAs to show policy makers the extent of concrete new investment potential and what needs to be done to realize this potential. It represents a bet-

ter formulated argument for what governments need to do to attract the FDI they programme into their plans and projections.

This approach has further implications for the manner in which IPAs should be structured and managed in order to give priority to the existing investor base. Appropriate structures and relationship management programmes, which facilitate and encourage this process, need to be put in place.

A second important conclusion of the survey points to the important role of an IPA as an investment climate "watchdog". General investment climate conditions, such as political and economic stability, transparency and legal framework are very important location factors to foreign investors when selecting a location in sub-Saharan Africa. Countries that are most successful in "getting their basics right" will be most attractive to these foreign investors. Policy advocacy is therefore of crucial importance and should be a key function within each IPA. The results of this survey, in combination with the close contacts to be developed (as indicated in the previous paragraph) with existing foreign investors, should provide IPAs in each country with sufficient input for setting priorities in business climate improvement needs.

Another important conclusion of the survey pointed to the need for IPAs to get involved with investors at an early stage. It appears that there is more scope for providing a broader range of services and consequently a tendency to have a larger proportion of satisfied investors. Nearly all the investors that were made aware of the investment opportunity in the country by the IPA and/or investors that got in touch with the IPA during registration and certification found this initial contact very useful for also using other IPA services and obtaining incentives and other benefits.

The survey also pointed to one other relatively low-cost promotion channel that is not fully exploited by many national IPAs. This is the significance attributed to seminars and inward investment missions. These can be low-cost operations that, on the basis of the survey data, produce significant results.

The survey did not indicate any great promotional benefit arising from the internet. This may be due

to the fact that most African IPAs have not yet integrated the internet into their investment programme. Nonetheless, this is a potentially low-cost and effective promotional tool that should be explored by these IPAs.

The overall implication of the survey is not that investment promotion in foreign markets should be abandoned. The influence of IPAs in creating awareness for future FDI should be increased where possible. IPAs should prioritize their promotion efforts on existing investors and use the product knowledge gained to approach the more difficult task of promotion abroad. Promotion to overseas companies should be targeted using some of the indicators coming out of the survey regarding source countries, motivations, size, market preference, etc.

There is great interest among investors in using IPA services, however many of them seem simply not aware of the service offering. IPAs should therefore create more awareness among potential investors through linkages with other national bodies involved in various aspects of investment promotion, facilitation and administration.

Survey results show that the most important services that could help investors expand in the country once they are established mainly include incentive related support, such as obtaining duty exemptions and other fiscal incentives, as well as accurate information on specific industry or business climate topics.

By studying, for each country, the specific requirements of investors who indicated what it would take for them to substantially increase their investments, the IPA could not only generate new investments from them but also determine where it has to improve service delivery and facilitation to influence investment decisions of broad categories of investors.

National governments

In general terms the findings of the survey for national policy makers are rather positive. A good share of the existing investors reports a reasonable level of satisfaction with the performance of their investment. Also a majority feels that the overall

investment climate has been improving since establishment and a majority is planning on further investments.

The survey pointed clearly to the fact that the domestic, as distinct from foreign markets, was the prime orientation of the existing FDI base in each country. However, the study also found that a smaller but quickly growing number of export-oriented companies is investing in the region. Recent trade agreements are luring these new export-oriented investments, in particular the AGOA trade agreement, and attracting an increasing number of investors keen on serving the United States market.

Location factors that influence the investors' decision regarding the location of investment reveal the high importance of an attractive and stable investment climate. Governments that take improvement of the political, economic and legal aspects of the investment climate most seriously will be among the most attractive locations for foreign investors. The survey results confirm the importance of efforts that have been made until now in most countries and should be a strong encouragement to continue enhancing the basic investment conditions in each country.

However, it is clear that there is much work to be done. The study pointed to several key areas requiring continued government attention these were:

- Governments should remain focused on enhancing general investment climate conditions including improvements in laws and enforcements of protection of life and property, flexible labour laws, swift liquidation and debt recovery.
- Regional and global trade agreements are considered important to existing investors and are offering good opportunities for attracting more FDI into the region. Survey results support the case for sustained government commitment to further economic integration at both the regional and global level.
- In addition to market conditions, current incentive schemes provided to the investor play an important role in future investment plans of existing investors. Particularly for

the fast growing contingent of export intensive investors these factors are very important. Governments should focus on designing competitive, win-win incentive policies.

- There is a clear responsibility for governments to ensure that national IPAs are receiving sufficient resources to be able to deliver at least the most important services requested by existing and potential investors. Without having full support from the national government, agencies are unable to harvest existing market opportunities and deliver services according to foreign investors' demands and expectations.

The survey enables governments to benchmark and monitor its performance on various aspects of the investment climate and other investor perceptions. It also helps governments to assess how much it needs to invest into the investment promotion process. The survey indicated that the services being provided by IPAs are important to foreign investors and they are generally ready to interact with the IPA if they deliver value added services.

Finally, the data obtained on the future investment plans of the firms surveyed should also be seen as extremely valuable from the point of view of national governments. In most developing countries, such data is completely lacking due to defects within the national statistical services and lack of resources among the IPA (or their recognition among the existing foreign investor base) to successfully conduct such large-scale research.

International Development Agencies

Most development agencies attach a high level of importance to the role of FDI as an agent of growth and prosperity. Yet sub-Saharan Africa is the least successful region in attracting the range of FDI that could support its development. Research into investor motivations and future investment plans as well as the IPA support services required by foreign investors on a country-by-country basis will help development agencies in planning and designing future assistance programmes.

Much of the International Overseas Development Assistance resources have been dedicated to spurring and sustaining growth through private initiative. The results of the survey and subsequent analyses that will be carried out will provide the opportunity to conceive and design targeted interventions that can potentially deliver the most impact per donor dollar.

Comparative data benchmarking countries and sub-sectors in terms of FDI performance and expecta-

tions adds a new dimension to the variables donors and development agencies used for targeting funds and programmes. Finally, through the trends and time series analysis it would be possible to see where progress is being made and where performance needs to be improved. This would also provide performance measures that indicate successes or failures of assistance programmes and suggest where corrective action may be required at any stage.

Introduction

The last two decades have witnessed rapid economic transformations accompanied by an unprecedented pace of technological innovation, liberalization of trade and globalisation of the world economy. Governments and enterprises of industrialized countries invest massively in R&D activities in order to bring about new processes, products and services as a way of overcoming competitive pressures, generating wealth and sustaining growth. However, apart from some exceptions, developing countries have neither financial resources nor the knowledge base to develop competitive technologies and achieve a fair share of the international trade to alleviate the poverty of their populations. This reality becomes more striking when we think of the countries in Africa and the LDCs. Foreign direct investment (FDI) is perceived as indispensable for the growth of developing countries in view of its multiple impacts. It is expected to bring skills and know-how leading to improved efficiency in the use of resources. Data on the net FDI inflows is given in the table below.

	1991	1992	1993	1994	1995	1996	1997	1998	1999	2000	2001
Industrialized Countries ^a	117,382.93	122,015.46	151,617.85	150,001.48	223,928.91	243,524.51	297,754.99	510,904.07	887,187.17	1,231,475.60	588,323.13
North Africa	799.46	1,505.22	1,604.37	2,160.08	847.85	816.21	1,249.08	1,956.47	1,669.65	2,388.98	574.00
Central Africa ^b	641.58	444.20	227.31	109.37	296.30	69.85	103.01	1,267.76	2,316.77	25.95	N/A ^c
Western Africa ^c	945.24	850.02	1,542.76	2,383.66	1,627.08	2,190.99	2,342.01	1,652.79	1,694.44	216.20	N/A ^c
Eastern and Southern Africa ^d	334.45	314.15	42.17	434.25	941.95	942.00	1,191.96	1,510.04	1,420.17	987.91	N/A ^c
Latin America ^e	12,930.77	15,073.16	13,773.63	28,625.18	30,039.29	43,724.19	65,610.72	73,439.63	87,843.3	74,813.40	52,981.90
West Asia and Europe ^f	2,154.29	2,754.58	3,236.51	1,984.01	204.51	3,050.83	5,565.23	7,366.45	3,316.57	1,674.09	5,661.23
South and East Asia ^g	19,266.70	24,600.07	44,357.25	54,555.74	62,521.31	74,866.21	82,873.44	87,607.06	93,042.73	124,607.38	31,643.67
Total Region	154,455.42	167,556.85	216,401.85	240,253.78	319,998.17	369,184.81	456,680.44	685,704.27	1,078,490.82	1,436,189.51	679,183.93

Amounts in US\$.

SOURCE: UNIDO Statistics compiled from International Finance Statistics (from International Monetary Fund) according to UNIDO List of countries and areas included in selected groupings in the International Yearbook of Industrial Statistics 2002

^a Data for Tajikistan, Uzbekistan and Federal Republic of Yugoslavia not available in IFS database.

^b Data for Democratic Republic of the Congo, Sao Tome and Principe not available in IFS database.

^c Data for Guinea-Bissau not available in IFS database.

^d Data for Reunion not available in IFS database.

^e Data for Bermuda, British Virgin Islands, Cuba, French Guiana, Guadeloupe, Martinique, Puerto Rico not available in IFS database.

^f Data for Iraq, Lebanon, Qatar, United Arab Emirates not available in IFS database.

^g Data for Bhutan, Brunei, Darussalam, French Polynesia, New Caledonia not available in IFS database.

^h Data not available.

The sub-Saharan countries included in the survey show a steady pattern in inward FDI flows⁴ as shown in Figure 1 below (average US\$ 2.4 billion per year) and particularly in their share of global FDI (0.3-4%).

Figure 1. FDI inflows in Africa and the 10 survey countries

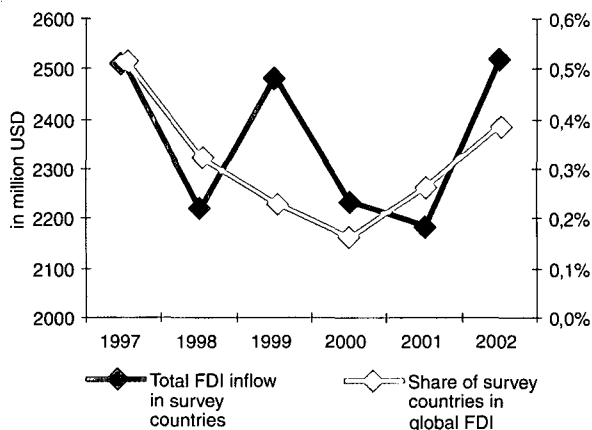

The potential benefits that FDI brings to economic development have been extensively researched and published. The main benefits offered by foreign investors relate to employment- and income-generation, exports, forward and backward linkages with domestic firms, transfer of new skills and technology, etc. The relatively poor performance of the African continent in attracting a better share of FDI implies it has not been able fully to exploit the potential of FDI for achieving basic development targets such as increased productivity, sustained growth, and the alleviation of poverty.

There are considerable challenges that developing countries and their policy makers have to face with regard to FDI promotion. Different forms of FDI have different impacts in such areas as labour market, (and segments within the labour market), productivity, trade, education, technological innovation, and so on.

Developing countries need FDI and compete for it. FDI has costs and effects that have to be the subject of scrutiny by host governments. From the investors' perspective there are expectations of profit that have to be balanced against the perceived risk,

which means the host country has to provide a climate of confidence for business

In the past, African countries, in common with those in other developing parts of the world, have been advised by multi-lateral development agencies and donors alike that they should improve the quality of their "product". In practice, this required achieving macro-economic stability, liberalising trade and generally removing barriers within their economic, political and administrative systems which created the disincentives to FDI.

Along with this, African countries were also encouraged and supported to set up Investment Promotion Agencies (IPAs) with the resources needed to "market" their attractions and smooth the way for incoming investors. These initiatives proved insufficient on their own to produce any great change in the competitiveness of African countries in the marketplace for FDI. This has been recognised by development agencies, who suggest developing countries need further to expand their approach to Investment Promotion by taking a more focused approach to the marketplace. This is often referred to as "Third Generation Promotion Policies".

The third generation of investment-promotion policies proceeds to target foreign investors at the level of industries and firms to meet their specific location needs at the operational and cluster level in light of a given country's economic development priorities. A critical element of such investment promotion is to improve and market particular national locations to potential investors in specific fields of activity. However, such a targeted approach, especially the development of location "brand names", is difficult, entails considerable financial and human resources and takes time. It requires fairly sophisticated institutional capabilities.

IPAs are being advised to make a radical change in their strategic approach to the marketplace for FDI and adopt "best practice" promotion techniques which have succeeded for their better-resourced counterparts in the developed world, especially in Europe. To achieve this, IPAs will need to deepen and improve their "product knowledge" of operating conditions for FDI in their own country. This involves obtaining a good understanding of the on-the-ground experience of existing foreign investors, their

⁴ Figures from the UNCTAD *World Investment Report 2003*.

satisfaction levels, need for IPA support services, future investment plans and the competitive advantages they have found within the country. In addition, IPAs need to obtain a clear understanding of their own role in the investment- promotion process and how they can better serve the needs of existing and incoming investors.

There has been little research at the company level on the actual experiences of FDI investors or on the relationship between investors and local IPAs in African countries that would provide answers to the issues raised above. As a result, there are wide gaps in the knowledge of investors' actual experience on the ground and what exactly needs to be done to improve the investment climate for firms on a country-by-country basis. This information is critical for national governments, international development agencies and IPAs in developing appropriate policies for encouraging FDI. This survey makes a contribution towards bridging this knowledge gap by bringing insights to the above-mentioned issues.

A perennial problem facing IPAs in African countries and their governments alike is the lack of resources for FDI Promotion. Unlike their counterparts in developed countries in Europe, African IPAs do not have the means to package and promote their "products" to the investment community. More importantly, African IPAs need to develop the wherewithal to influence policy making to overcome the government and market failures that keep their "product" outside the margins of international production networks and capital flows.

The high-cost model developed in Europe, which is frequently used as a reference frame, is beyond the means of many developing countries, especially Least Developed Countries (LDCs). This does not mean that many features of these "wealthy and developed" agencies are irrelevant. Many of the techniques developed are valid and must be aspired to by all IPAs. However, the techniques and practices need to be modified and adapted to cater for the realities that confront IPAs in Africa.

In order to focus their limited resources, African IPAs need to obtain a better insight into economic impact, growth prospects and after-care needs of specific groups of foreign investors. This requires

an analysis of different categories of investors in order to be able to synchronize priorities and resource allocation with national development goals.

UNIDO is in a position to play a key role in addressing and seeking solutions to these and related issues. By virtue of its close cooperation with African IPAs and broad based presence in integrated programme countries, UNIDO has the means to develop and test new approaches and cost-effective initiatives that would expand the range of options open to these IPAs.

This survey of 10 African countries is a follow-up to the pilot survey conducted in 2001 in Ethiopia, Nigeria, Uganda and the United Republic of Tanzania. It needs to be placed and viewed in the much broader context of the Organisation's programmes to assist economic and social development in sub-Saharan Africa. There are currently 18 ongoing integrated industrial development programmes in the region. These programmes cover a wide range of development issues and most of them include a major component relating to FDI and skill-development at local intermediary institutions.

The survey's objectives

It is hoped that by providing better information on such pertinent issues as the motivation of foreign investors, their satisfaction levels with their current investments, their needs in terms of IPA services at various stages of the investment, understanding of the specific barriers to investment expansion and commitment to their existing locations and future investment plans, the survey will contribute to a new understanding for developing policies that would encourage future FDI flows to each country. Research on the role of local IPAs in facilitating FDI in each country surveyed is intended to get a better appreciation of how they perform and contribute to the overall process.

The ultimate aim is to produce the survey on a bi-annual basis to provide high-quality information on the factors that currently facilitate and encourage FDI flows to sub-Saharan countries and to explore the effects of FDI on development goals. The survey is also intended to provide precise information on

the role of national IPAs in this process and continuously to gain a better understanding of the strategies and techniques that actually work in the context of sub-Saharan Africa.

The survey's objectives can be organized by the three key players involved in investment promotion in Africa:

In relation to existing foreign investors, the survey aims at developing a better understanding of:

- Who the typical investors are in sub-Saharan Africa, in terms of sectors, size, origin, operations, entry-mode, etc. of existing foreign investors.
- What motivates them to invest in sub-Saharan Africa?
- The services and support they require from the host country at various stages of the investment process.
- Their experience with the local IPA and the quality of services provided.
- The economic impact these investors have in a country and how this impact varies between different categories of investors.
- Their perceived performance of their existing investment in the country and their short-to-medium term investment intentions in the region (foreign investment outlook).

To determine, in relation to Investment Promotion Agencies (IPAs):

- How these agencies can make an increased impact in terms of attracting and retaining investment in the short term.
- The perceived benefit and performance according to foreign investors and identify

the main service areas offering opportunities for performance improvement.

- The support requirements of investors for undertaking new investments.
- Facilitate benchmarking on the type and quality of services provided by African IPAs, and progress made in enhancing FDI promotion capacity.
- Provide insight to IPAs as to which mechanisms have favourably influenced FDI decisions and which have deterred FDI.
- Support the development of comprehensive strategies and focused Investment Promotion Programmes to maximise IPAs' economic development results.

In relation to National Governments, International Development Agencies and other Donors:

- To uncover government and market failures in the African FDI landscape and how to use the survey results in providing guidelines for FDI policy development and the organisation of FDI promotion to governments.
- To understand the economic impact of FDI and how to leverage existing FDI to the benefit of the domestic private-sector and economy.
- To provide guidance to donors and development organizations on the added-value of assistance programmes focusing on increasing the flow of FDI into Africa.

The survey was conducted in the 10 countries between June and September 2003. The final results and analysis were presented at the UNIDO Africa Investment Promotion Agency Network's annual conference held on 2 - 4 December 2003 in Vienna.

Survey methodology

Data collection method and timetable

This first full-scale survey among the 10 sub-Saharan AfriPANet countries greatly benefited from the experience and lessons learned from the pilot survey conducted for four countries in 2001. In survey design as well as organization, the pilot survey proved to be a solid basis and provided valuable experience in implementing the survey in the 10 countries.

The survey was organized through the UNIDO offices in the respective countries, utilizing the networks established in the course of implementing the integrated programmes (IP). National consultants recruited through the UNIDO Representative's office undertook the task of distributing the questionnaires. Their responsibilities were the briefing of the targeted respondents on the objectives of the survey, walking them through the questionnaire to ensure that the respondent understood everything and returning at an agreed date to pick up the completed questionnaire. The respondents were given several days to complete the questionnaire. The questionnaire was designed to be completed in as little as 20 minutes if data such as employment, revenue and manufacturing value added were readily available. In some countries where it was impossible to cover the territory for delivery and pick-up, some regions were covered by sending the questionnaire by courier and briefing the respondent by phone. This methodological approach ensured the possibility of high numbers of returned questionnaires.

The IPAs were kept out of the survey process as much as possible to maintain the confidentiality (except in one country where there is no UNIDO office and the IPA assisted in selecting and briefing the consultants). In most countries UNIDO offices were responsible for the selection and briefing of the national consultants and for supervising their work.

Data-collection took place over four months from June to September 2003. The schedule required that questionnaires be returned and analysed before October to enable the final report and results to be presented at the UNIDO – Africa Investment Promotion Agency (IPA) Network Seminar in Vienna in December 2003.

Selecting the sample

In selecting the convenient sample for the survey, a similar approach to the sample selection for the pilot survey was used. It was decided that desegregation of samples by sector and firm size (either employment- or sales-based) should not be done for this survey to keep sample sizes to manageable levels. However, it was decided that the questionnaires would seek information for each company on their business sector, number of employees and current sales levels, that broad indications of their distribution could be obtained from analysis of the survey results. Another compelling reason for not performing any desegregation in terms of sample was the lack of reliable and comprehensive data on the total population of foreign investors

in each country, including sector and size characteristics.

Target population and target respondents

As stated earlier, the survey's central objective was to develop an in-depth understanding of foreign investors' perceptions and motives for investing in sub-Saharan countries, their experiences in the host country, the economic impact of those investments and their potential for future investment. Once this understanding has been acquired, the results will serve as input for assessing institutional development needs among individual IPAs in the survey countries for the benefit of policy design.

The initial list of companies to target for the survey was put together from a variety of sources. Primarily, these were the IPAs (list of foreign based companies registered with the IPA), local and international Chambers of Commerce, embassies of countries known or suspected to be major source of FDI in the country, Manufacturers' and other professional associations, Registrar of Companies and other country specific sources. The list was sifted through to eliminate pure mining companies, small pure retail trade businesses and small hotel/restaurant businesses and concentrated on manufacturing companies that were located in easy-to-reach regions. The reason for opting for this selection rather than adhering to a random selection was to keep the analysis clean of the concerns and motivations of investors in sectors that are known to have particular issues that differ from those investors in manufacturing.

The total number of 2195 questionnaires sent out equalled the total number of foreign investors selected in each country. The number of returns was 818 representing an overall response rate of 37%. The average response rate per country is considered an excellent response rate for surveys of this type.

Although overall response rate was excellent, sometimes not every individual question was filled out by the respondents. In subsequent analysis, the 'no-response' category per question has been excluded and does not show in all graphs or tables in this report. Therefore, the number of useable returns

was 758, representing a usable response rate of 35%. This figure surpasses most others in empirical studies of this type.

Since this was primarily a perception survey, it was considered very important to ensure that the highest-possible data quality be returned. The questionnaires had to be obtained from the most senior managers possible in each company. The views and experiences of the principal decision makers were essential. The survey was very successful in this respect. More than 90% of respondents were senior line-managers (such as Managing Director, Marketing Manager or Financial Controller) or higher. Table 1.1 below sets out the distribution of the positions of respondents for the pilot survey.

Table 1.1 Distribution of respondents by position within the company

	<i>Percentage</i>
Chairman, Managing Director or Owner	35
Director, Company Secretary	11
Senior Manager (except financial)	26
Financial Manager	17
Assistant, Analyst, PA, Secretary, etc.	5
Consultant, Specialist Advisor, etc.	2
Accountant	5
Total	100

Sample size

Statistical rules do not necessarily demand a sample size that represents a fixed proportion of the total population size. The sample size formula for a survey of a large population that does not contain a population-size factor is defined by the equation:

$$\text{Respondents required } N_o = 1 / \text{acceptable error}^2$$

(Formula 1)

In the case of smaller populations, an additional factor can be used to reduce the sample size further. So for an acceptable error of plus or minus 10%, the number of respondents required = $1/0.1^2 = 100$. Similarly, for an acceptable error of +/- 5% or +/- 3%

the number of respondents required is 400 and just over 1100 respectively.

Following consultations, it was decided to aim for an accuracy of +/- 3% to 4%. For a larger population, the above formula would have required between 1111 and 625 returned questionnaires. However, based on the results of extensive data-collection on foreign investors in each country, the foreign investor population in the survey countries was estimated at less than a thousand.

Corrected sample Number $N_c = N_o / (1 + N_o / P)$, where N_o is the sample determined by Formula 1 above and P is the population of foreign investors, as per the country IPA (Formula 2).

Table 1.2 below sets out the desired sample size, the actual number of companies surveyed and the resulting accuracy obtained as per Formulae 1 and 2.

The pilot survey stressed the importance of the IPAs ensuring that their investor list was fully up-to-date and had accurate contact details. The initial lists provided were found to contain some incomplete or out-of-date data and required additional work by the local UNIDO office, IPA and local consultants to ensure a representative sample was eventually obtained. Despite these difficulties, acceptable final accuracy levels were obtained for the survey.

Table 1.2. Survey responses (percentage)

<i>Country</i>	<i>Surveys Sent</i>	<i>Surveys Returned</i>	<i>Response Rate</i>
Kenya	304	92	30.2
Tanzania	226	101	44.7
Madagascar	229	89	38.9
Nigeria	300	88	29.3
Ethiopia	90	70	77.8
Burkina Faso	183	59	32.2
Mozambique	228	99	43.4
Cameroon	165	60	36.4
Uganda	166	95	57.2
Senegal	304	65	21.4
Total	2195	818	37.3

Procedure for selecting companies for the sample

The country IPA provided an alphabetical client list of foreign investors to UNIDO for selection of the sample list. UNIDO in turn issued the final list, including company contact information from the various other sources to the selected consultants.

As many companies as possible were identified for inclusion on the sample list to obtain a maximum coverage of foreign investors per country. The main focus was on foreign owned companies (more than 30% foreign ownership) with manufacturing operations in the country.

The requirements for selection of the local consultants included experience in conducting surveys in the country in question (and in particular experience with the pilot survey).

Questions and layout of the questionnaire

Question selection

The questions were selected to ensure that the objectives set for the survey would be fully achieved. The pilot survey questionnaire was used as a solid base, but changes and additions were made to the pilot survey questionnaire as appropriate. The full set of questions is given at the end in Annex I.

The priority criteria for the questionnaire were that it be short, easy to complete and have validity and reliability. It was designed to capture both the perceptions of the investors about the host country and the national IPA as well as information about their motivations, decision making process, performance, impact on the economy and their future intentions about further investment and expected growth.

Layout of the questionnaire

The variables in the questionnaire were laid out in eight short sections. These are:

- Profile of the company and operations in the host country

- Motivation for original establishment or recent major new investment
- Investment and operating experience in the host country and with the IPA
- Economic impact in the host country
- Future outlook
- Additional Questions (how they would make their location decision if they could make it all over again)
- Closing questions (if they would like to have their answers made known to the IPA and if they would like to be contacted by the IPA)
- Contact details

Two language groups occurring in the 12 countries – English and French – were used.

Most of the information was to be gleaned by simply checking boxes to indicate a position on a Likert scale. For example:

What level of new (i.e. in addition to depreciation replacement) investment are you planning to make over the next three years in <Country>? (amounts are in US\$).

<100k 100-500k 500k-1m 1m-5m 5m-10m 10m-25m 25-50m >50m

In addition to the use of Likert scales in the questionnaire, some questions were framed to allow multiple responses to a range of categories and some were framed to allow free-format answers of up to 100 characters.

The multiple-response format was used where a number of responses might apply, such as, question 34: *'With which of the following local organisations in <country> has your company had or continue to have a relationship?'*

Here the respondent could select several answers from a larger range of possible answers.

Various important questions were structured following a closed multiple-response format, whereby each option needed to be checked, reads as follows: For example Question 17 in the set: *'Why did you choose to invest in <<country>>? (Please tick the appropriate boxes, indicating the importance of each factor in your location decision AND tick to indicate if there was any change in those conditions you marked as 'important' or 'crucial')*. Even if a particular location factor was not important in making the decision on location, respondents would have to tick the 'unimportant' box.

The free-text format was used in a few situations:

- Firstly, where it was not possible to pre-define categories for the use of check-boxes, for example, questions such as these were usual: *'What are the top three improvements you suggest the country IPA make to their services?'* — Questions 25. The answers received to these questions during the survey were grouped into categories during the final analysis.
- Secondly, where contact information was required.

The use of this structure simplified subsequent data entry, checking and analysis. A Microsoft Access data-entry database was developed to speed up the data-entry process and secure consistent and high-quality data entry.

Coding, data entry and checking data entry

The data on the questionnaires were collated by country, coded where required and entered into a database set up in SPSS 11.5. The sets of data entered were checked for any missing entries or other inconsistencies, and then cross-checked against the original questionnaires.

Analysis of survey respondents: A profile of who is investing in sub-Saharan Africa

This chapter will look at who is investing in the target countries, what sectors they prefer, where they come from and what some of the trends are over time.

The main focus will be on understanding the dynamics in terms of sectors, investor origins, fields of activity, size, entry mode, ownership structure and markets served by these foreign investors. Various academic research projects and publications have already contributed to developing insight into some of these topics and for some of these sub-Saharan countries. This study intends to complement many of these macro-level analyses and understandings based on anecdotal evidence, surveys of IPAs and MNC Headquarters as well as many in-depth sub-sector studies investigating the relative competitiveness of the respective countries. It is anticipated that the data can be used to develop a number of benchmarks and achieve a much deeper level of understanding of FDI in the region.

The analysis of the respondents in this chapter includes:

- Number of respondents per country of investment
- Main business sectors represented
- Respondents' country of origin
- Year of establishment
- Main field of business activity
- Mode of entry
- Company size (by investment value and employment)
- Market orientation

In general the companies were positive about the objectives of the survey and the response can be considered very constructive and positive. In addition to the overall response rate of 40%, nearly 60% of these respondents expressed a wish to be contacted by the IPA to discuss future investment plans. Companies were very keen to provide information to help improve IPA services and the investment environment. 58% of respondents gave permission for the information in the returned questionnaires to be released to the relevant IPA.

Furthermore, 60% of respondents stated their investment had performed in line with or above expectations in the last 3 years. Less positive, however, was the fact that only 51% of respondents indicated a desire to re-invest in their current country location.

Number of respondents per country

The analysis was performed on 10 sub-Saharan African countries, as illustrated in Figure 2.1. Overall, 758 valid (out of a total of 818) responses were recorded. There were variations by country in the quality of selection and targeting of companies by the national consultants. It

Figure 2.1. Number of respondents by country of investment

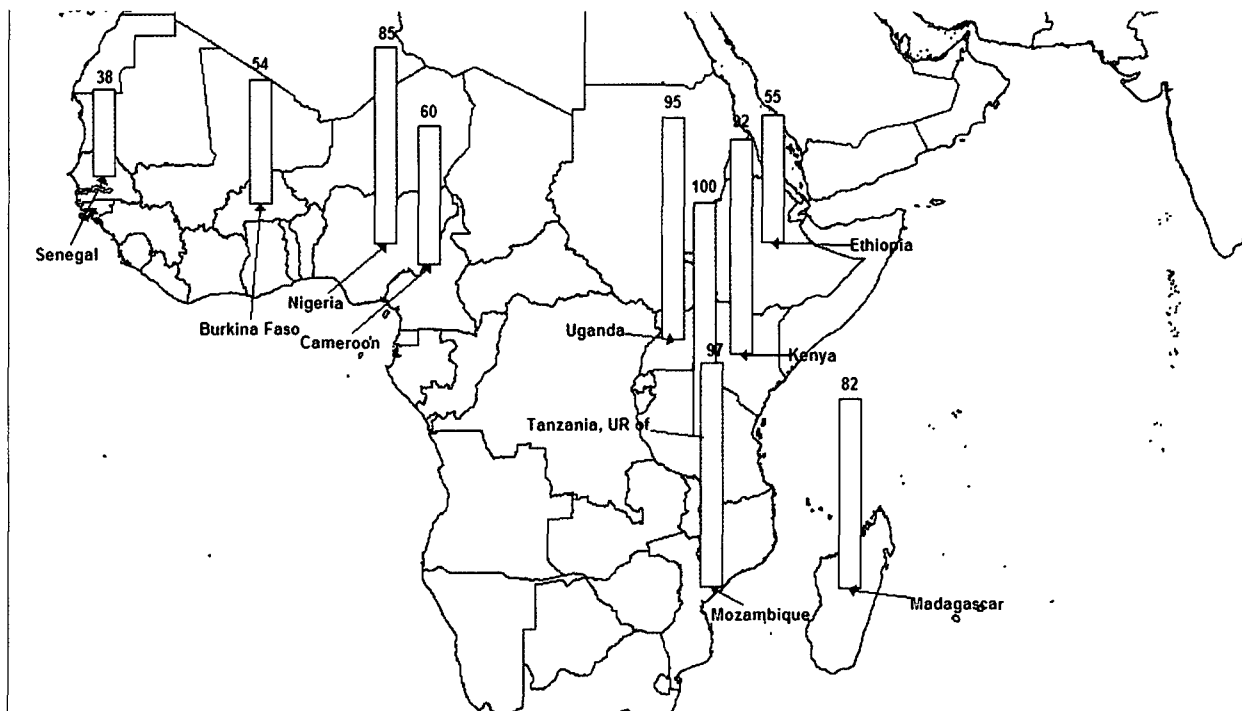

is therefore not assumed that the number of responses reflects the proportion or number of foreign based companies in each country. Due to disruptions during the survey the coverage in Nigeria was somewhat more limited than expectations and Senegal coverage was less than anticipated.

Sector coverage

Figure 2.2 provides information on the sector distribution of respondents. It is important to note that these proportions do not represent the distribution of FDI among the different sub-sectors that may be reflected through a random selection of companies to be targeted. As mentioned earlier, the selection of companies from the initial long list was biased towards manufacturing and against mining as well as small-scale retail, distribution and services.

In subsequent analysis, sectors were categorised into sector groups where applicable. For example, *motor vehicles* and other *transport equipment* were placed in one sector category. Several key target sectors for many African IPAs were analysed individually and

not aggregated in larger sector categories (e.g. wearing apparel, textiles, etc.).

Figure 2.3 shows that at a more aggregate level, eight sub-sectors account for 60% of all investment in the region. These are:

- Food and drink
- Other chemical products
- Agriculture and tobacco
- Wearing apparel
- Wood, pulp and paper
- Metal products
- Machinery
- Financial intermediation

A detailed overview of the sector categories has been provided in Annex II.

Figure 2.4 presents the main sector distribution of foreign investors by country.

Overall, food and drink is an important sector for inward investment for most countries. A closer look at the individual countries shows that Cameroon, Tanzania and Uganda attract a higher-than-average share of foreign investment in this particular sector.

Figure 2.2. Distribution of respondents by sector

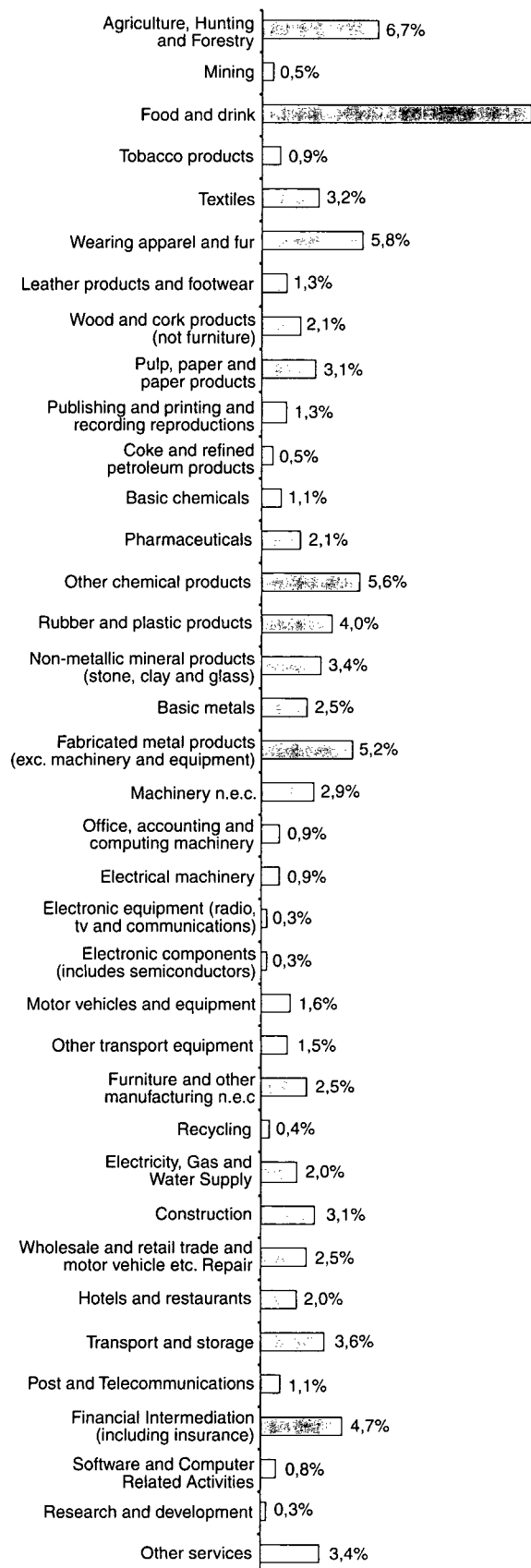
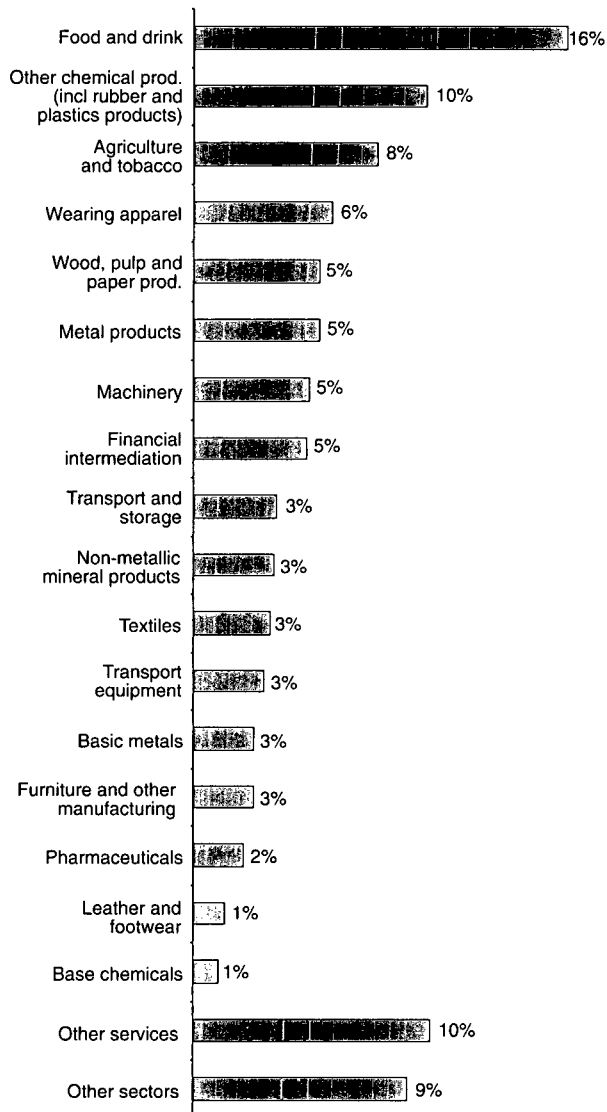
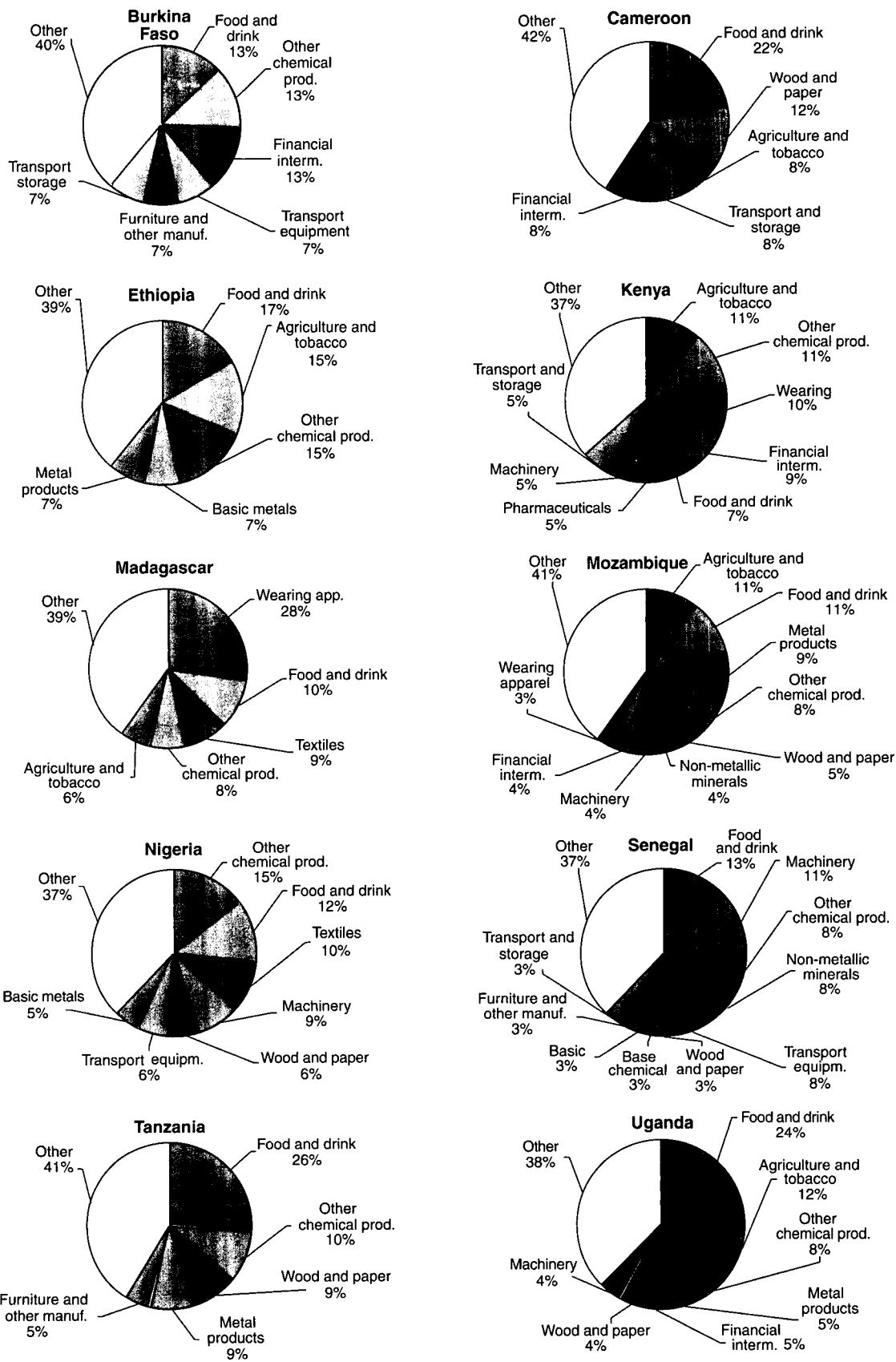

Figure 2.3. Distribution of foreign investors by sector category



In each of those countries, the food and drink sector makes up more than 20% of all foreign investment projects. Apart from Kenya and Madagascar, the food and drink sector appeared to be the main sector of respondents in all countries surveyed. One reason for this can be explained by the fact that a large portion of the FDI in Madagascar is export-oriented and in Kenya there are large plantation type agricultural investments (mostly exporting of tobacco, tea and coffee) and more basic industries that were established much earlier than most FDI in the other countries.

Figure 2.4. Distribution of sector categories per country by category



The second-largest group among the respondent population were companies operating in the Sector “chemical and rubber and plastic products”, which includes products such as paint, soap and detergents. Ethiopia, Nigeria and Burkina Faso show particular strengths in attracting investors in this sector, with about 14% of the respondent population within each country belonging to this industry category.

Ethiopia, Kenya, Mozambique and Uganda are countries that are relatively more dependent on agriculture and tobacco sector for inward investment. Between 11% (Mozambique and Kenya) and 15% (Ethiopia) of respondents were agriculture and tobacco companies (coffee, tea, agribusiness)

Wearing apparel is the biggest sector in Madagascar, with 28% of respondents. In Kenya it was the third-biggest sector for FDI after agriculture and tobacco and other chemical products.

In later analysis it will be observed that there is a close correlation between the main sectors in a country and relative timing of the arrival of FDI. In most cases the more recent arrivals are in the export-oriented sectors such as apparel.

“Other services” and “Other sectors” also make up an important part of the sector distribution. Wholesale and retail operations (26%), hotels & restaurants (21%) and posts-and-telecommunications operations (11%) are the main components of other services.

“Other sectors” comprises a variety of sectors, with construction (35%) being the largest constituent. This is attributable mainly to Ethiopia, where construction accounts for 15% of all respondents. Electricity, gas and water supply (23%) and publishing and printing (15%) were other important constituents.

More details on all sectors by country can be found in Annex IV.

Origin of respondents

The survey was directed to foreign investors in sub-Saharan Africa. A definition of *at least 30% foreign capital* was used to define the “foreign investor”. Of the 69% of companies that indicated the origin of their parent company. The largest groups consisted of European investors (40%) and African investors (34%). However, only half of those African investors indicated a country of origin other than the country of investment.

In the total group of African investors, South African companies are the main investors, with one-third of all investment projects. This finding on African investors is highly interesting and its implication will receive close attention in Chapter 4.

Whereas in other parts of the world the United States and Japanese companies are typically a major source of foreign investment, they appear to be the most striking absentees among our survey population in sub-Saharan Africa.

Graph 2.5 provides an overview of the key source markets for investments in the eight key sectors for FDI. A more detailed table for all sectors has been included in Annex II. The percentages are based on the number of respondents who provided the parent company’s country of origin. A relatively large number of the 238 respondents left this particular question on the parent company’s origin blank.

Analysing the investors’ origin by sector in more detail, it appears that:

- European investors are the main investors in sectors such as agriculture, basic chemicals, pharmaceuticals, non-metallic mineral products and financial intermediation. European companies are largely absent in the wearing-apparel sector.
- African investors are strongly present in the textiles, wearing apparel, metal products sectors and other manufacturing sectors. South Africa proved to be the most important investor in the survey region.
- Asian investors are particularly strong in the wearing-apparel sector.
- United States companies have a low presence overall, but financial services and

Figure 2.5. Distribution of main sector categories by origin

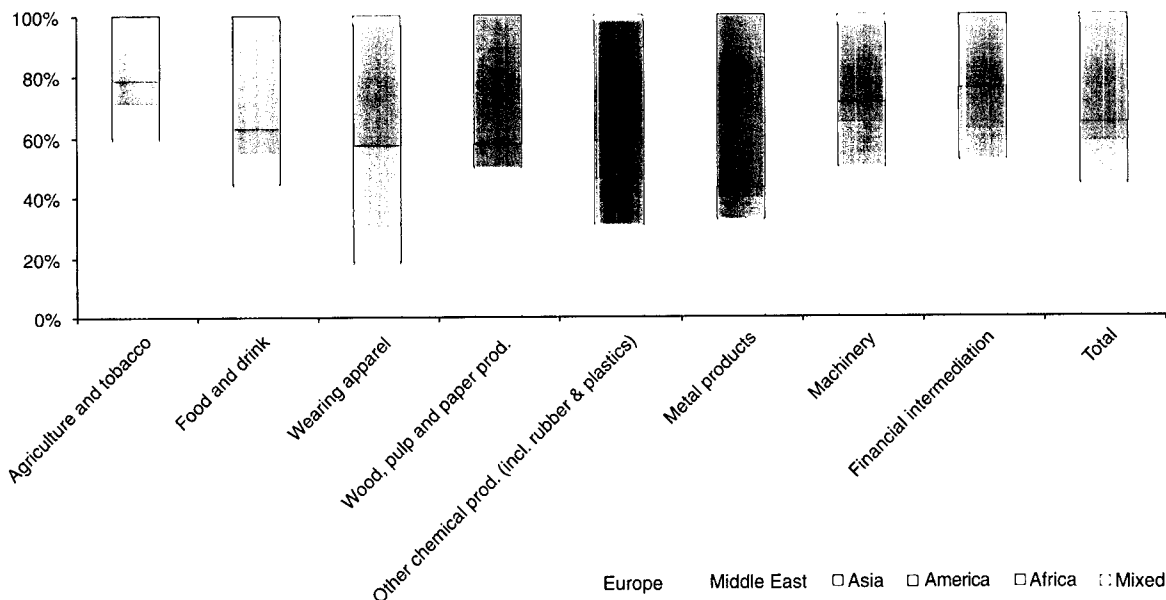

other chemicals are the most important sectors of activity.

Again there is a strong correlation between the home country, sector and timing of the arrival of FDI. The earlier arrivals are the Europeans, concentrating on resource-based (mostly agriculture and forest based) investments.

Source of investment varies widely by destination country. Interesting results were:

- European investors predominate in Cameroon (resource-based).
- More than 60% of investors in the United Republic of Tanzania have African origins (market-seeking).
- US companies are mainly found in Kenya or Uganda.
- Some 25% of investment projects in Madagascar originate in Asia, which is largely the result of the importance of FDI in the wearing-apparel sector for that country. As indicated above, Asian investors predominate in the flow of foreign investment in the wearing-apparel sector in Africa.

Respondents by year of establishment

Over 50% of the respondents were established after 1995. About 35% were already in the region before 1995 but did have a major new investment since.

The large number of recent investors among the respondent population supports the relevance of the survey's results dealing with investor's motives for investment in the country, the investor's experiences with the IPA in the pre- and post-investment decision phase and the service requirements of those investors from IPAs.

Figure 2.6. Distribution of foreign investors by year of establishment

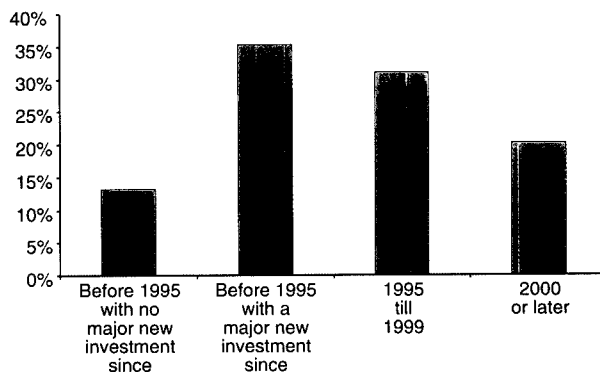

However, it must be kept in mind that the selection process may have skewed the sample towards the more recent arrivals since most of the institutions approached for the information, especially the IPAs, did not have much knowledge of companies that were set up prior to their own establishment.

It is also interesting to note the high level of significant re-investment in many companies that arrived prior to 1995. The decision process, at the time of initial investment, of the earlier arrivals may not be captured in the survey but their recent decisions to expand their investment will.

Graph 2.7 shows some interesting results on sector mobility. Sectors that show increasing inward investment over time were, in order of importance:

1. Wearing apparel
2. Furniture
3. Textiles
4. Machinery
5. Agriculture

A third of the largest exporters in this survey have been established only very recently. This is due to the fact that agriculture and wearing apparel are among the sectors with the highest export-orientation. At the same time they are among the sectors expanding most aggressively in the region since 2000.

Clearly, expansion investments are an important part of the investments in all sectors. Particularly transport equipment, transport and storage, non-metallic mineral products, other chemicals and agriculture have a considerable share of companies that were already established before 1995, but had a major investment since.

A closer look at the year of entry for these sectors revealed some interesting findings. Firstly, it appeared that about 80% of respondents in transport equipment and transport services sectors were already established in the region before 1995. Pharmaceutical companies were mainly established during the period from 1995 to 1999.

More recently, the wearing-apparel industry in particular has been investing in sub-Saharan Africa, with 43% of respondents being established during the last three years. During the period since 2000,

Figure 2.7. Distribution of sector categories by year of establishment

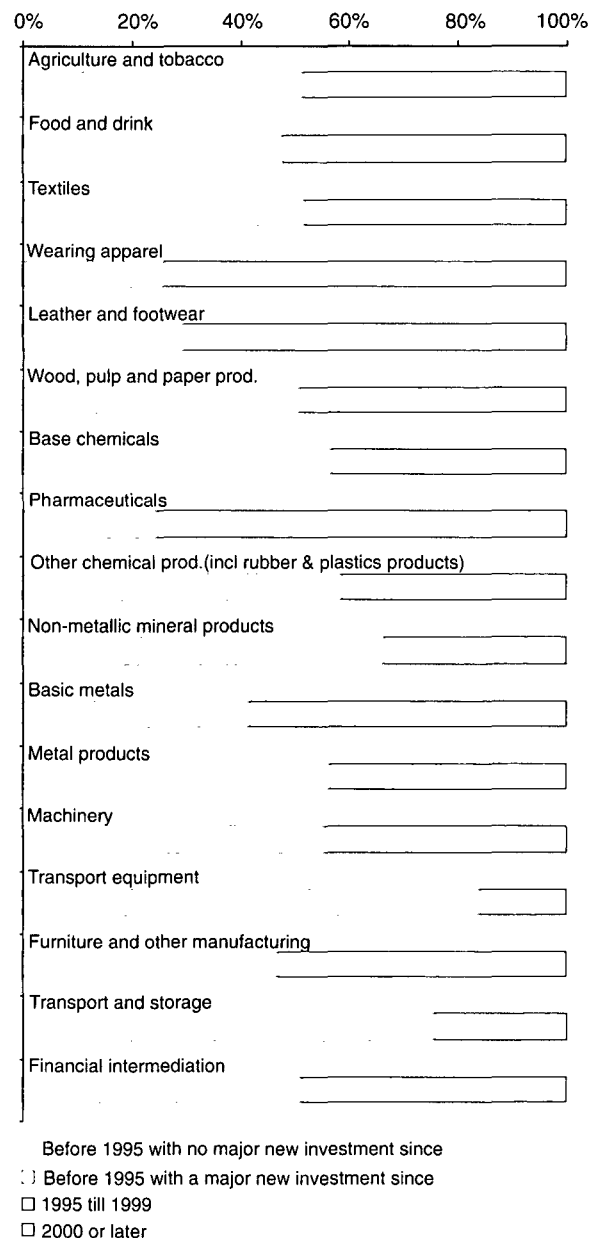

the wearing-apparel sector became the number one investor among the respondent population, taking over from the food and drink sector which used to be the most active investor in the region. Nevertheless, the food and drink sector since 2000 has proved to be the most stable and remains a very important sector overall in terms of the number of new investment projects.

Figure 2.8. Distribution of foreign investors by year of establishment

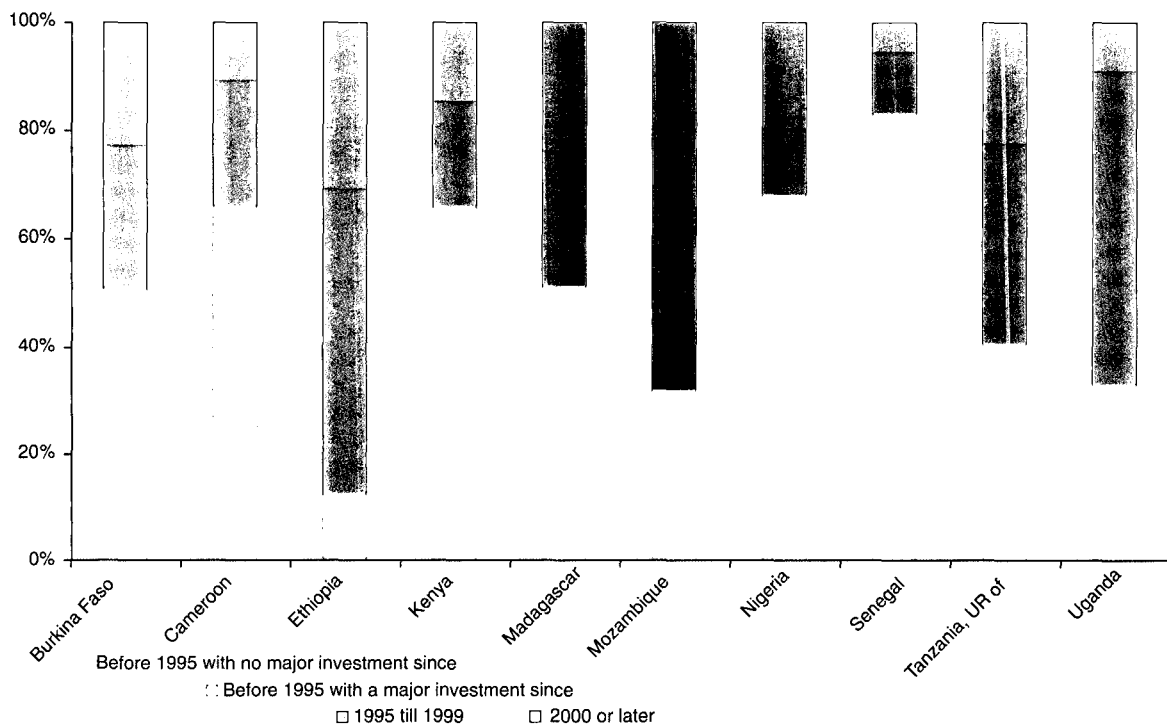

Figure 2.9. Distribution of year of establishment by origin

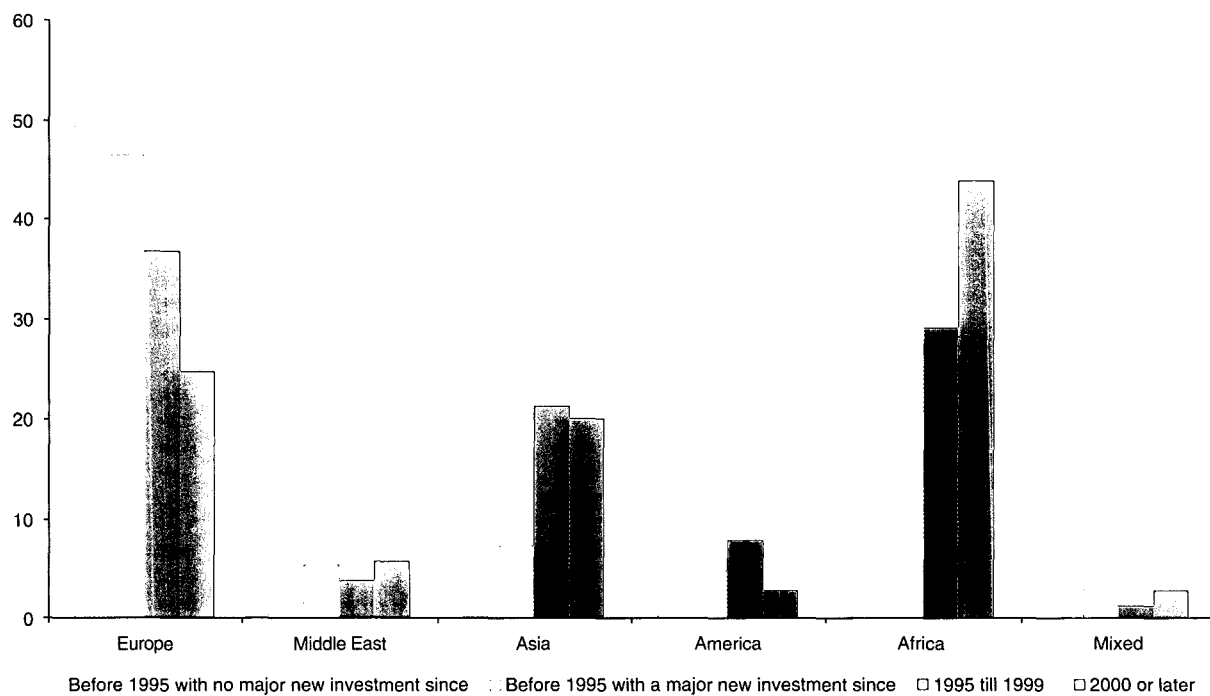

Figure 2.8 analyses the period of investment per country. Ethiopia, Uganda and Mozambique seem to be among the 'emerging markets' for FDI in sub-Saharan Africa. These countries have seen a recent influx of investors especially in agriculture, food and drink and/or other chemicals. Kenya, Nigeria, Cameroon and Senegal on the other hand seem to be among the more mature markets for FDI in the region. Interestingly, more than 60% of all recent investment in Kenya was found in only one sector: wearing apparel.

The importance of African and especially Asian investors has grown in recent years, at the expense of Europe's position as the major investor in the region. Since 2000, Asian investors have become almost as important as European investors, whereas African investors have become the leading source for FDI.

Although European investors are becoming less important in terms of inward FDI, they are still actively expanding their existing operations. Nearly 50% of the existing European investor base that was established in the region before 1995 has increased its commitment in the region with major new investment since then.

Respondents by main business activity

More than two-thirds of all respondents had manufacturing as their main business activity (as mentioned earlier, this is a result of the selection

process). Over 90% of those were manufacturing or assembling finished products. The remaining third of respondents had services, transport and distribution, sales and marketing or construction as their main business activity. Research and development or headquarters operations were the primary activity for only a marginal percentage of the respondents.

More detailed, activity focused analysis, provided some interesting findings with regards to manufacturing, export and technology intensity of foreign operations.

Manufacturing oriented activities

About 33% of all foreign investors in the survey were involved in non-production activities. Kenya, Cameroon, Senegal, Burkina Faso and Mozambique had between 44% and 46% of respondents in non-manufacturing oriented activities. The highest percentage of manufacturing oriented respondents (85%) was observed in Tanzania.

Non-manufacturing activities were mainly concentrated in the services sectors, sales and marketing activities and transport and distribution activities. Especially sectors such as machinery (60%), pharmaceuticals (38%), transport equipment (38%) and other sectors (55%) were relatively more involved in non-manufacturing activities.

Export-oriented activities

One of the areas this study could shed some light on is the role of FDI in export and regional trade. How much can we learn about the factors that influence export-oriented FDI; where it is going, how well is it performing in the target countries, what sectors benefit most, etc.

Figure 2.11 shows that only 16% of all foreign investors in sub-Saharan Africa can be classified as export-oriented investors. The survey results suggest that the 'no answer' category consists mainly of companies without any exports, which brings non-exporters to nearly 60% of the foreign investor population in the region. A table has been included in the Annex IV (Table D) providing more detail on the share of large exporters (>75% of sales from exports) as a percentage of all respondents by country and sector.

Figure 2.10. Distribution of respondents by activity

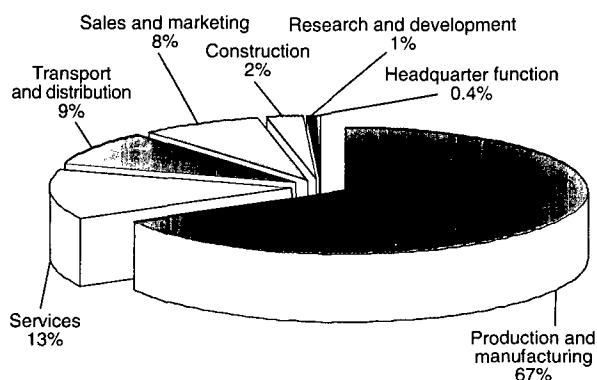
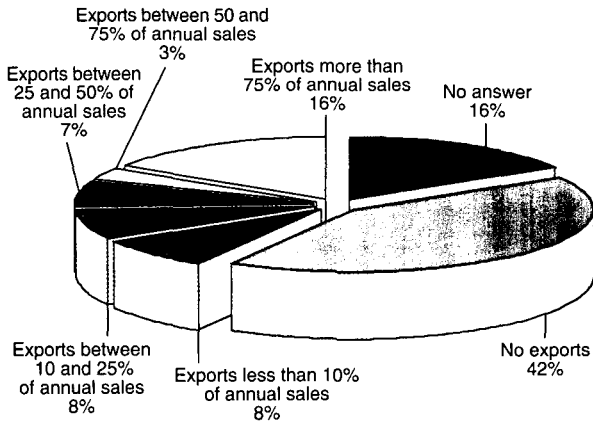

Figure 2.11. Distribution of respondents by export intensity



Sectors with a particularly large share of export-oriented industries are agriculture and wearing apparel, followed far behind by textiles and leather and footwear. All other sectors have a very strong local or regional market focus.

The selection bias against mining and in favour of manufacturing will have skewed the figures against exports since mining would boost the export numbers.

Countries attracting relatively more export-oriented industries are Madagascar and to a much lesser extent Kenya, Cameroon and Ethiopia as well. As shown before, Madagascar is attracting a large number of companies in the wearing-apparel sector, which is the most export-oriented industry among foreign investors in sub-Saharan Africa. The main export-oriented industries in Kenya are agriculture and wearing apparel. In Ethiopia this is mainly due to the strong presence of foreign companies in the agricultural sector.

Figure 2.12. Distribution of sector categories by export intensity

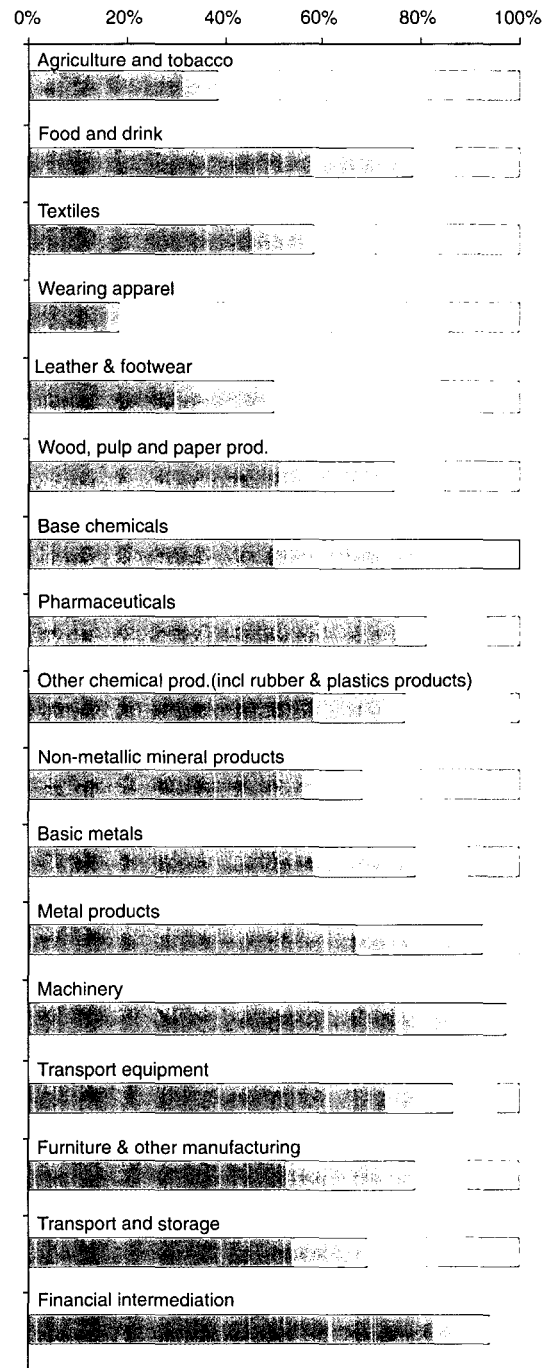

- No answer or no exports
- Exports below 25% of annual sales
- Exports between 25% and 75% of annual sales
- Exports more than 75% of annual sales

Figure 2.13. Distribution of foreign investors by export intensity per country

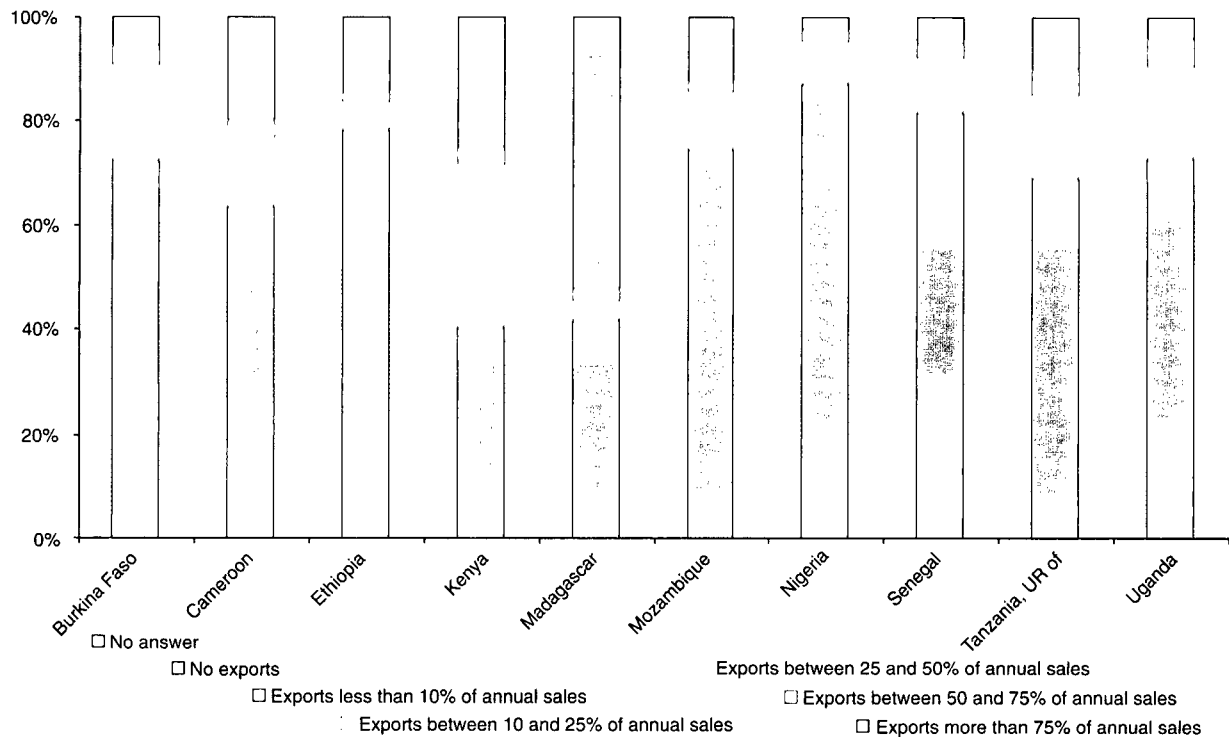

Analysis of the entry years of large exporters among the respondent population produced some interesting results. It appears that one-third of all large exporters in the foreign-investor population has set up in the region only very recently (since 2000). This finding seems to suggest that the inflow of large exporters into sub-Saharan Africa is a relatively recent phenomenon and the number established is showing a clear upward trend: 17% of respondents in this category set up between 1990-1995, 26% between 1996-2000 and 33% since 2000.

Technology-intensiveness of operations⁵

In the latest *Industrial Development Report*⁶ it was concluded that developing countries have less technology-intensive production and exports, but the gap between industrialized countries was narrowing. The importance and potential contribution of techno-

logically sophisticated production and export facilities of foreign companies to developing countries lie mainly in their perceived potential for technology transfer, and hence the technological upgrading of local industries and industrial infrastructure.

About 17% of all respondents with production activities in sub-Saharan Africa can be classified as medium-to-high technology companies. However, the large majority of respondents in sub-Saharan Africa (83%) run resource-based or low-technology-based operations. Countries showing a relatively higher share of foreign investors in the medium-high technology range were Burkino Faso, Ethiopia, Nigeria and Senegal. Especially investment projects in the pharmaceuticals and medical products sector were among the medium-high tech sectors.

It is interesting to note that these four countries are also the same four with the least export-oriented FDI as seen in the previous graph. Any causal link between the technological intensity of FDI and low export-orientation of FDI would need a closer look in subsequent analysis of the data and perhaps nar-

⁵ For details of technology classification see Annex III.

⁶ UNIDO *Industrial Development Report 2002/2003*.

Figure 2.14. Distribution of respondents (manufacturing) by technology intensity

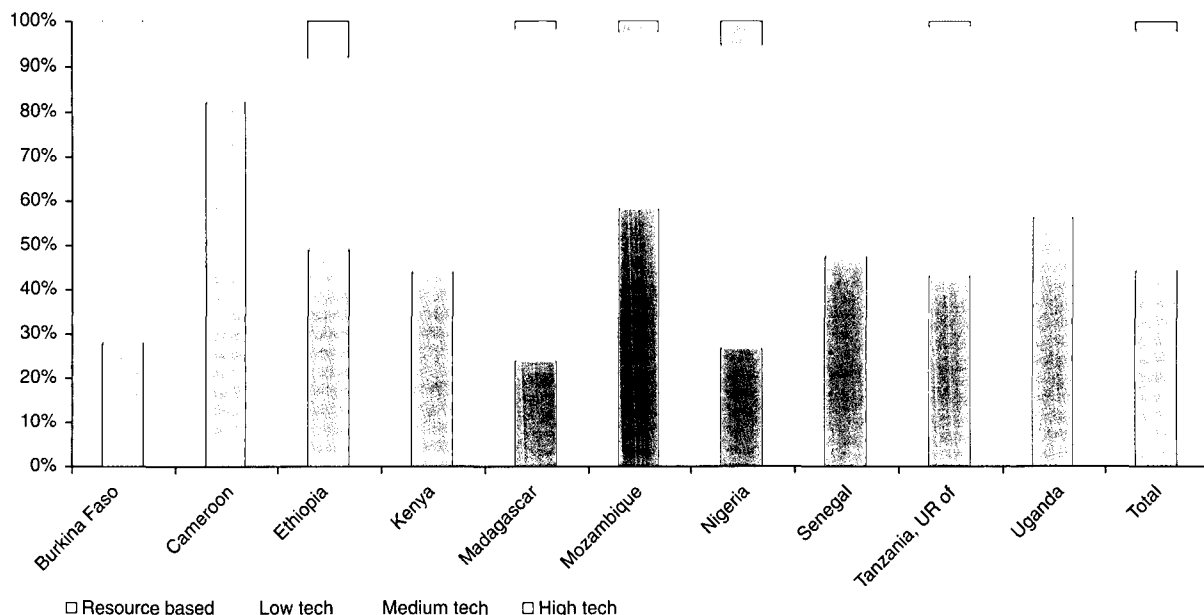

row specialized questionnaires for investigating this possible link may be necessary.

An above average representation of companies in resource-based and low-tech sectors was found in Cameroon and Madagascar. As seen before, these countries have strong concentration of wearing apparel, food and drink and textiles (Madagascar) and food and drink and agriculture (Cameroon), which explains their higher share.

Entry mode

Multinational firms expanding into emerging markets can choose between different market entry options. The main options available to a foreign investor are setting up a greenfield investment, joint venture or acquiring a local company. Particularly in the African context, match-making is a prominent task for the IPA, whereby local firms or investment proposals and projects of local firms are promoted to foreign companies in order to benefit from their financial and managerial capabilities. This paragraph analyses the strategic decisions on market entry taken by foreign investors in sub-Saharan Africa.

Figure 2.15. Distribution of foreign investors by entry mode

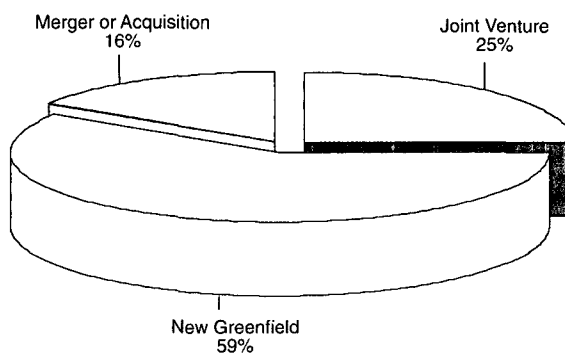
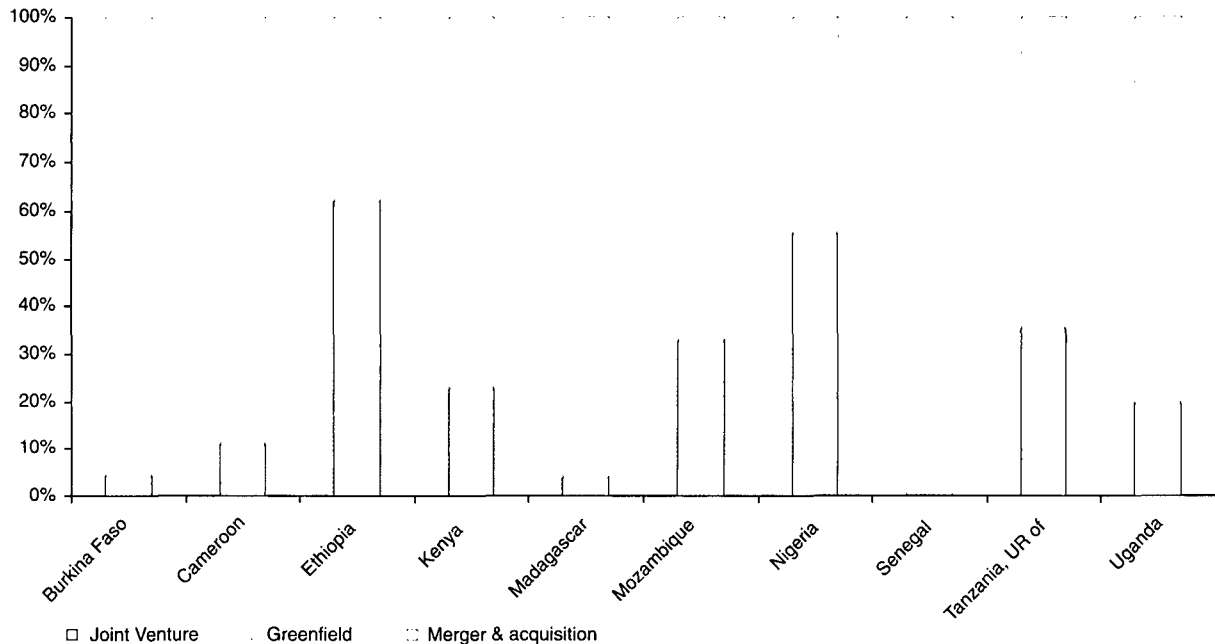

Figure 2.16. Distribution of respondents by mode of entry per country



Greenfield investments are the preferred entry mode for foreign companies in sub-Saharan countries. On average, nearly 60% of all investments enter the region as a greenfield investment project. Approximately 25% of investment enters the region through a joint venture with a local company.

Large variations were found between countries when it came to the preferred entry mode. Countries showing a relatively high percentage (> 75%) of greenfield entries were: Burkino Faso, Cameroon, Madagascar and Senegal. Countries showing a relatively low percentage of greenfield investments were: Ethiopia and Nigeria. In both countries joint ventures were preferred over greenfield entries. In Ethiopia a relatively high number of joint ventures were counted in agriculture, other chemicals and pharmaceuticals and basic metals and metal products. Nigeria showed a relatively higher number of joint ventures in several sectors particularly in food and drink, textiles and other chemicals.

It is interesting to note again that these two countries are precisely those with the least export-oriented and most technologically sophisticated FDI. This observed parallel could be further investigated, even though the preference for FDI for joint ventures in these two countries is probably more a reflection

of the investment climate and regulatory bias perceived by investors.

Greenfield entry was the dominant entry mode in all sectors except for pharmaceuticals. Also the non-metallic mineral products and textiles sector were showing relatively more interest in other modes of entry. Sectors with a relatively high share of foreign investors opting for JV or M&A are listed in Table 2.1.

In some sectors the number of respondents was too low to draw any statistically-significant conclusions on the preferred entry mode. Cross-checking the entry mode against company size and investment

Table 2.1. Sectors with high share of foreign investors

Sectors with interest in JVs	Sectors with interest in M&A
1. Pharmaceuticals	1. Textiles
2. Basic metals	2. Non-metallic mineral products
3. Non-metallic	3. Pharmaceuticals
4. Food & drink	4. Machinery
5. Agriculture	5. Transport & storage
6. Other chemical products	

Figure 2.17. Distribution of sector categories by mode of entry

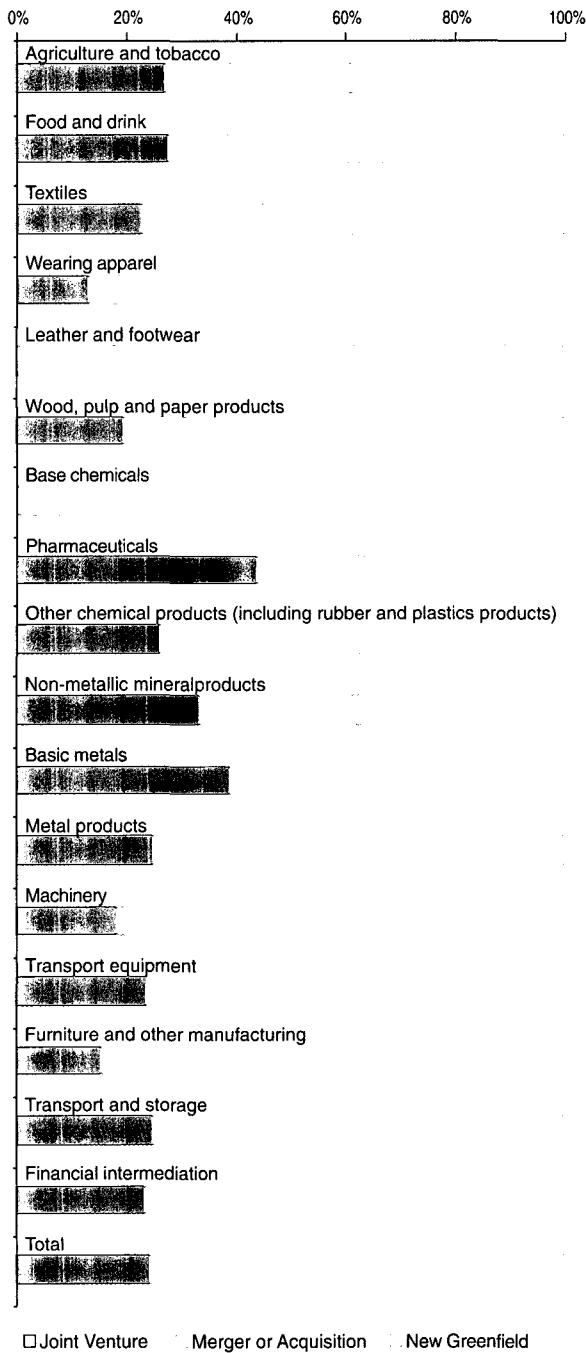

value revealed that almost 24% of the mergers and acquisitions were companies with more than 250 employees. 24% had a current investment value of over US\$ 50 million.

Company size

Size of existing investment

The largest group of investors in sub-Saharan Africa falls in the total current investment value category of US\$ 1-5 million (26% of respondents). About 25% of the respondents indicated a total value of current investment of US\$ 10 million or more.

Figure 2.18. Distribution of foreign investors by current investment in the country (USD ; k=thousand ; m=million)

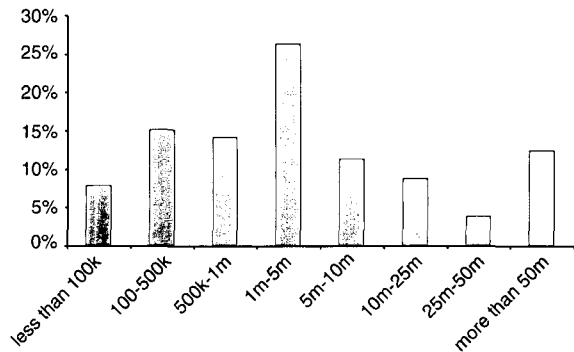

Nigeria had the lowest proportion of smaller companies (value of current investment less than US\$ 1 million) among its foreign investor population, whereas Mozambique and Madagascar had about 60% of the respondent companies with less than US\$ 1 million investment value. Especially Kenya and Nigeria stand out with a relatively higher percentage of large foreign investors having an investment value of more than US\$ 50 million.

Again some of the distributions in size can be attributed to the distribution of sectors in the countries. Madagascar for example has a large share of apparel sector companies that are typically smaller in investment size.

Some sectors show a relatively high share of smaller size companies in terms of investment value. Particularly the wearing apparel sector (48%), Machinery (52%), Furniture and other manufacturing (63%) and the other services sector (52%) contained a relatively large share of smaller sized investments. The only sectors showing a relatively larger number

Figure 2.19. Distribution of respondents by current investment in the country per sector

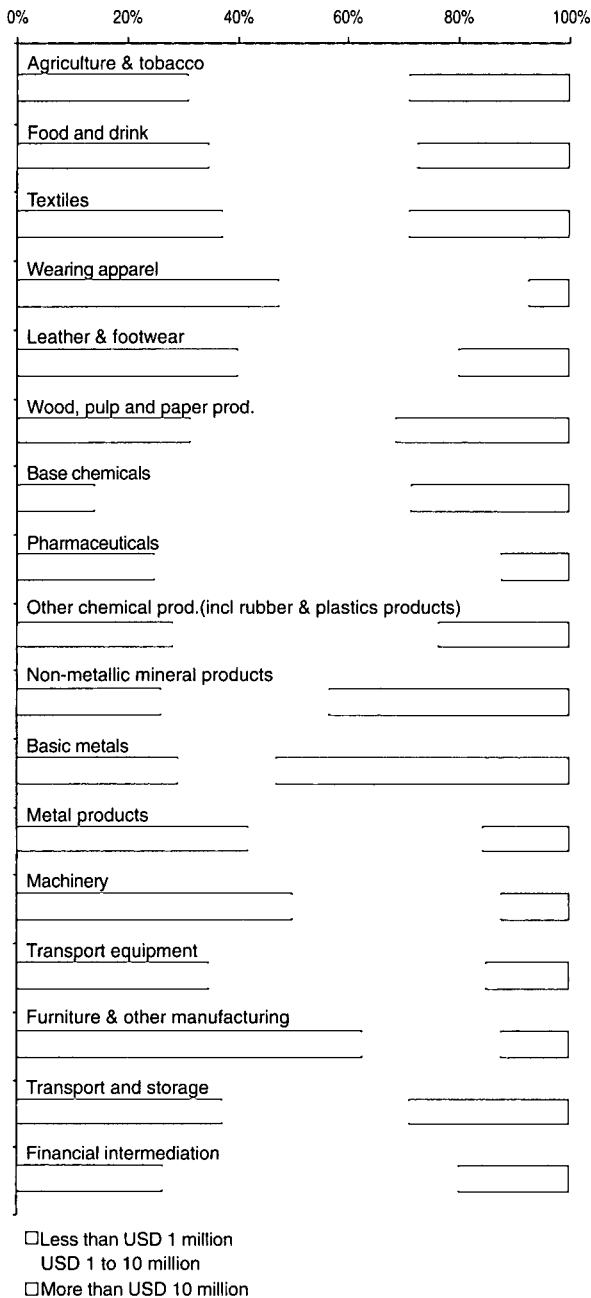

of companies in the higher categories were non-metallic mineral products and basic metals where over 40% of the companies had an investment value of more than US\$ 10 million.

For most of the countries, the number of employees in the companies and current investment values do correlate, except for Madagascar which shows a bigger number of larger companies but also a high share of respondents with a small investment value. This could be attributed to the high share of wearing apparel companies in Madagascar. Companies in this sector generally have a lower capital to labour ratio.

No significant relation was identified between the value of capital investment and the origin region.

The Figure 2.20 shows the distribution of companies in each country by number of employees. Approximately 75% of foreign investors in sub-Saharan Africa had fewer than 250 employees. Half of those were small companies of fewer than 50 employees.

Overall, only 25% of the respondent population fell into the category of large companies (250+ employees). Over one-third of foreign companies had fewer than 50 employees. Sectors with a high number of foreign investors as well as a relatively high percentage of large companies were agriculture and tobacco (50%) and wearing apparel (74%).

Kenya and Madagascar had the highest proportions of larger companies, with each country having close to 40% of foreign companies with an employment level above 250. Analysis showed that large companies are strongly represented among the group of large exporters, which explains the results for these two countries. Kenya, Ethiopia and Cameroon stood out in the proportion of very large companies (over 1000 employees) among their respondent populations. A large proportion of these very large companies consist of wearing-apparel and food companies.

In Mozambique over half the respondents were small companies in the range of 1 to 50 employees. Senegal, Burkina Faso and Ethiopia also had a relatively higher proportion of smaller companies. More country and employment category details are given in Annex IV.

Figure 2.20. Distribution of foreign investors by employment category per country

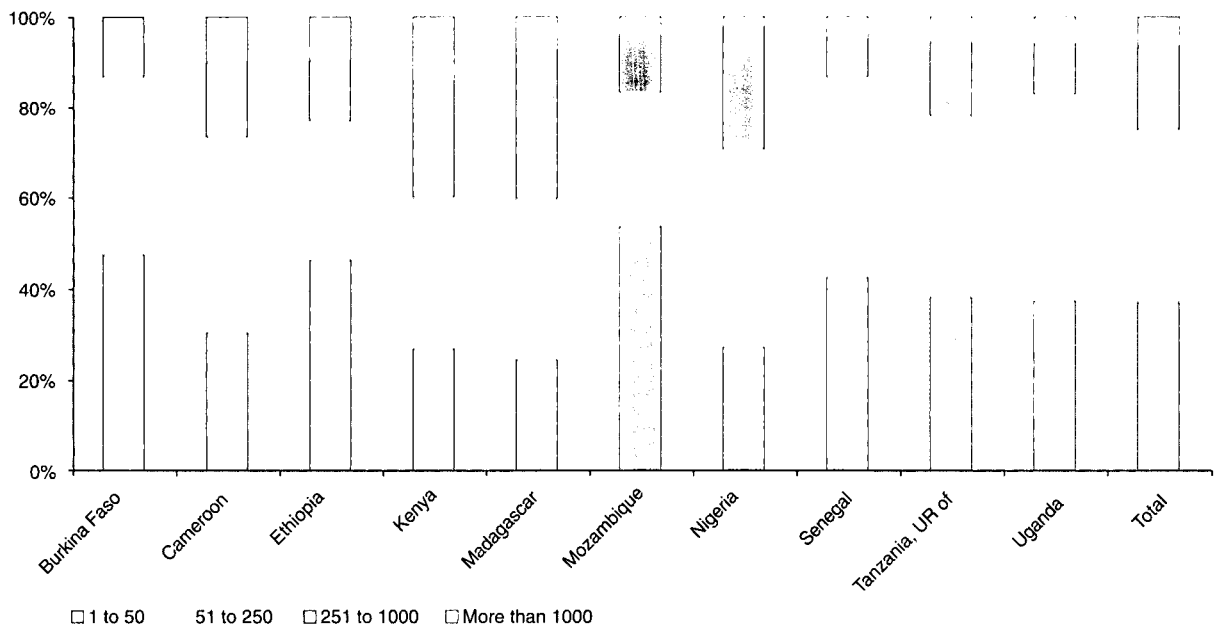

In the remainder of the analysis, companies were grouped into three employment categories:

- Fewer than 50 employees
- Between 50 and 250 employees
- More than 250 employees

Combining the company size data with the export data a clear pattern is observed. The smaller companies export smaller portions of their outputs and those that export major portions of their outputs are the largest employers. A direct conclusion from this observation may be that export-oriented investment promotion enhances employment generation.

This is reflected in the sectors agriculture and tobacco and wearing apparel which are the sectors of both the largest exporters as well as the largest companies. This is also reflected in the country distribution since Kenya and Madagascar both host the largest number of large companies and the largest number of big exporters.

In Madagascar 28% of respondents are active in the wearing apparel sector which partly explains the relatively larger presence of big exporters. In Kenya both Agriculture and tobacco and wearing apparel are main sectors.

Figure 2.21. Distribution of foreign investors by employment category per level of export intensity

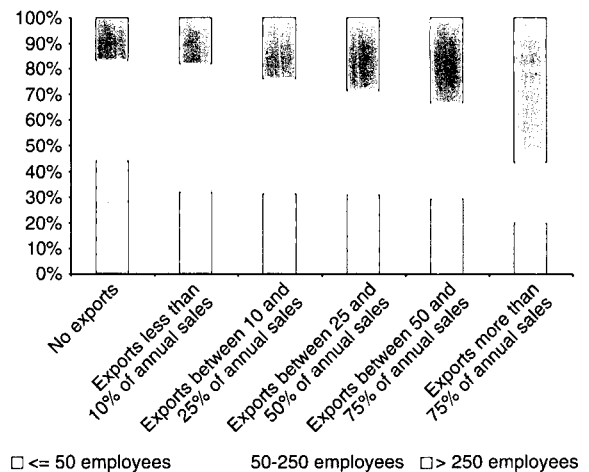

Market orientation of investors

The importance of regional trade agreements to investors in sub-Saharan Africa was also studied. Looking at some of the regional trade agreements, a sizeable portion of respondents either take advantage of them or find them an important parameter for their business. Since this survey does not include all countries that are part of these trade agreements the results are not representative but rather indicative.

Figure 2.22 reflects the percentage of medium and large exporters (exporting over 25% of annual sales) that considered the trade agreement as important. Overall, the results can be summarized as follows:

- COMESA (Common market for Eastern and Southern Africa): between 45-50% of the medium and large exporters in Kenya, Tanzania and Uganda found COMESA important to their operations in Africa. Exporters based in Madagascar & Ethiopia attached less importance to this trade agreement. Noteworthy is the high importance in Tanzania which is not part any-

more of the regional grouping of 20 countries of COMESA.

- EAC (East African Cooperation) involves three of the target countries; Kenya, Tanzania and Uganda. Investors in Uganda seem to put much higher importance on this agreement than those in the other two. This may be an indication that investors targeting the EAC as their market prefer Uganda over the other two, but this would need to be studied more closely.
- WAEMU (West African Economic and Monetary Union): Particularly foreign investors in Burkino Faso find the WAEMU agreement very important. Two-thirds of the medium and large exporters indicated that this agreement was important and more than 50% of the smaller exporters pointed to the importance of this agreement to their operations.
- SADC (South African Development Community): About one-quarter of the small exporters and over half of the larger foreign exporters in Mozambique found the

Figure 2.22. Percentage of medium and large exporters attaching importance to trade agreements

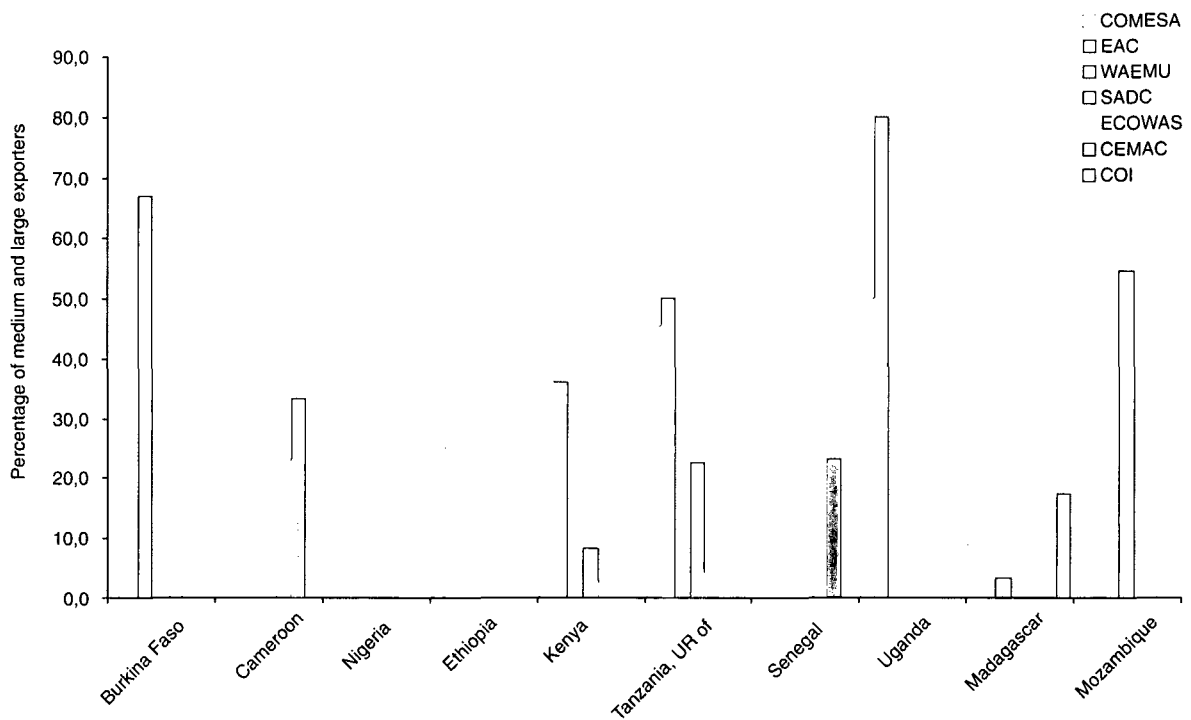

Table 2.2. Export intensity versus markets served (percentage)

	<i>Exporting to neighbouring countries</i>	<i>Inter-Exporting to Africa</i>	<i>continental exports</i>	<i>Total</i>
Exports less than 10% of annual sales	73	6	21	100
Exports between 10 and 25% of annual sales	77	2	21	100
Exports between 25 and 50% of annual sales	71	2	26	100
Exports between 50 and 75% of annual sales	65	0	35	100
Exports more than 75% of annual sales	9	0	91	100
Total	47	2	51	100

SADC agreement important. This overwhelming importance of SADC to investors in Mozambique probably reflects the importance of South Africa as a market for investors in that country.

- ECOWAS (Economic Community of West African States): relative to the response for other trade agreements, only a small share (on average less than 25%) of the foreign exporters in the relevant countries found ECOWAS important. The small number of response to this agreement adds to the impression that this agreement is considered less important to foreign investors. Only in Nigeria it is of a unique importance and in Senegal it has the same importance as CEMAC.
- CEMAC (Central Africa Economic and Monetary Union) is important for 35% of Cameroon exporters and for 23% of Senegal exporters.
- COI (Commission of the Indian Ocean) is important for 20% of respondents in Madagascar. It is the main trade agreement for Madagascar.

African markets are a major destination for exports.⁷ Within Africa, Uganda, Tanzania, Kenya and Rwanda were indicated as key export markets for the respondent companies. Further analysis revealed that in many cases these exports are mostly from neighbouring countries.

⁷ Table A in Annex IV provides a more detailed overview of the most important export markets by sector.

Outside Africa, nearly all exports are directed to the United States and Europe. Very few respondents were exporting to the Middle East or South-East Asian markets. Figure 2.23 below provides an overview of top export markets by sector.

A clear difference exists between export focus and sectors. Agriculture and Wearing apparel companies are very much focused on export markets outside Africa, whereas companies within the remaining sector categories export mainly to other sub-Saharan African markets. This finding could contribute to the relative importance contributed to the different regional trade agreements that exist as indicated earlier.

In general, the largest exporters (more than 75% of annual sales) are also the companies that exported to Europe, Asia or America.

Figure 2.23. Main exporting sectors by destination region

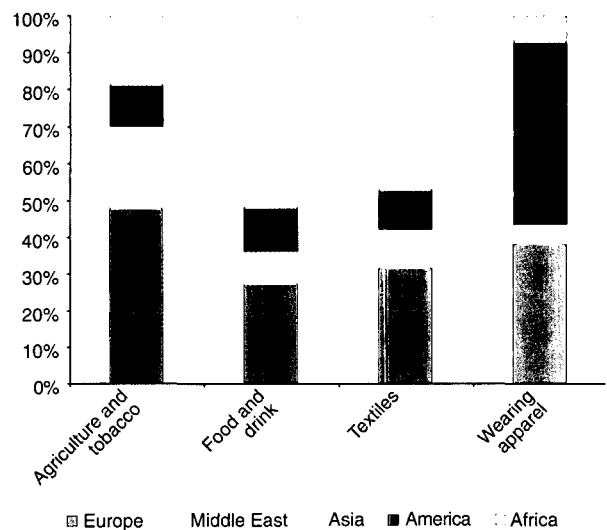

Investor motivation and important respondent categories

Why are these investors coming to sub-Saharan Africa?

This short chapter provides an introduction to the three main groups of foreign investors in the survey by motivation. During subsequent analysis these three groups have been closely analysed for their respective characteristics:

- Investors in primary industries (resource-based investors)
- Investors serving local and regional markets (market-seeking investors)
- Investors serving continental markets (export-processing investors)

The group of **resource-based investors** represents investors belonging to primary and resource-based industries (see Annex III for definition). This group is largely dominated by European investors followed at distance by African investors. The group includes a large number of companies that are counted among the large exporters, which is mainly due to the agriculture sector (see graphical profile).

The group of **local market-seeking investors** comprises all companies that indicated that the local and/or regional market was either important or crucial in their location decision. The market seeking FDI category is a dynamic group with nearly 50% of the respondents established after 1995 and 37% established before that date but having a major new investment since. Local market seekers are typical smaller size companies (see graphical profile). Companies in *food and drink* and *other chemicals* (including e.g. paints, soaps and detergents) sectors are important market-seeking investors.

The group of **export-based investors** consists of companies that export more than 75% of sales to continental markets. This group is increasing in importance and showing growing inward investment dynamics. The majority of the companies in this group are larger companies (>250 employees). These companies prefer primarily a greenfield entry mode. Key sectors in this group are wearing apparel, agriculture and food and drink (see graphical profile).

Some overlap among the three investors' groups exists, particularly between the resource-based investors and market-seeking investors. The reason is that an investor can very well be in a resource-based industry and local market-seeking at the same time.

The foreign investor response database allows for various interesting and more detailed analysis which have not been performed or published within the framework of this study. Particularly, by adding new variables to the database such as a political risk index, corruption index, average labour costs, donor funds spent on investment promotion capacity building, etc. or combining survey data with other research results could provide more valuable results and insights.

Besides more in-depth country specific analysis on all the results published in this report, the information obtained through the survey would also allow for more analysis on e.g.:

- The importance of foreign investment for strategic sectors in each country
- The contribution of foreign investment to local cluster development
- The contribution of foreign investment to country exports
- The contribution of foreign investment to country employment and income generation

- The impact of regional and global trade agreements on new and existing foreign investments

Also the database would allow for monitoring the impact of various capacity-building projects related to investment promotion in these countries. For example it could be used to start monitoring the impact of ongoing UNIDO programmes related to identifying investment opportunities and promoting these opportunities through the global ITP network. Also, ongoing work of other United Nations organizations in the survey region related to capacity-building of IPAs could be monitored in terms of impact.

Figure 3.1. Profile of resource based manufacturers

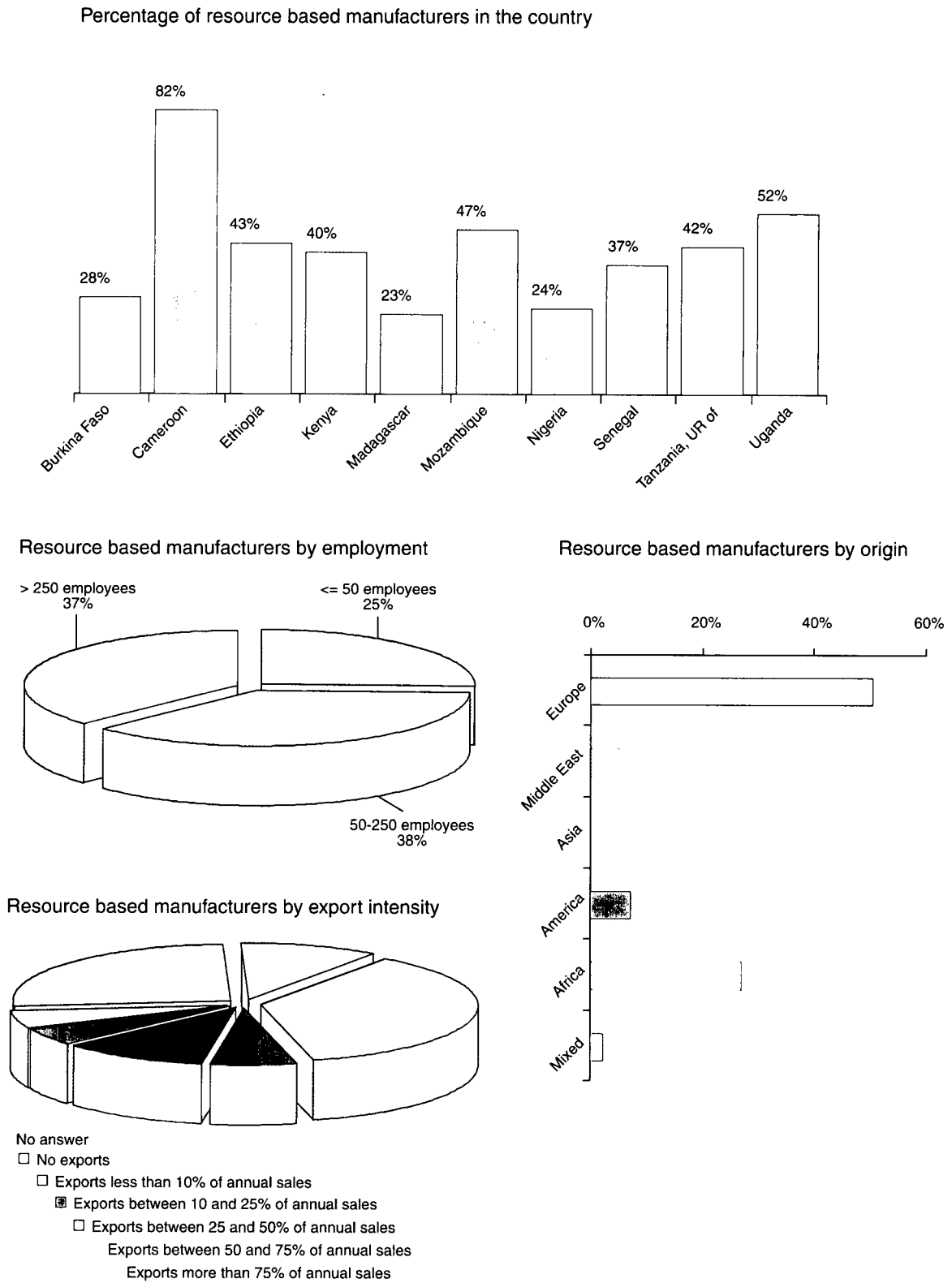
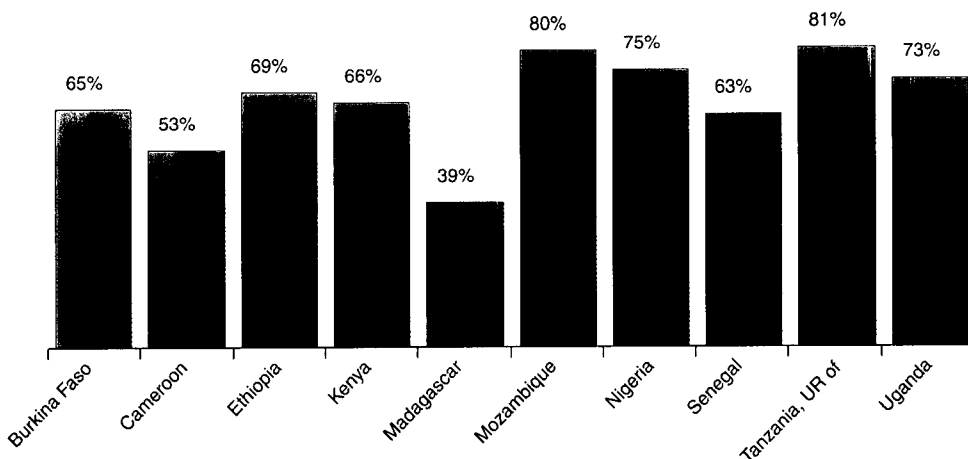
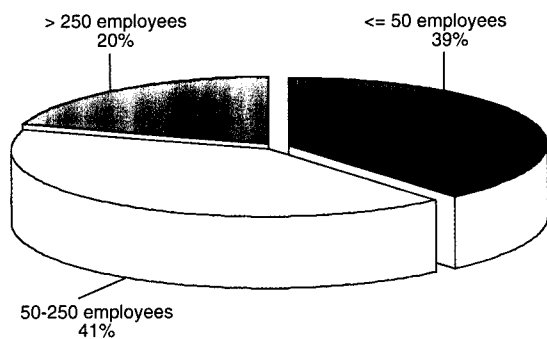

Figure 3.2. Profile of local market seekers

Percentage of local market seekers in the country



Local market seekers by employment



Local market seekers by sector (main sectors)

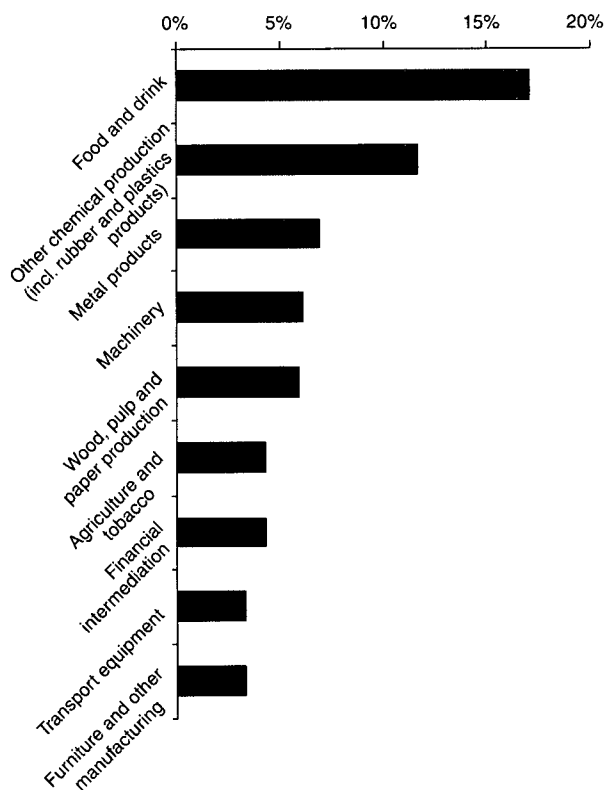

Local market seekers by period of investment

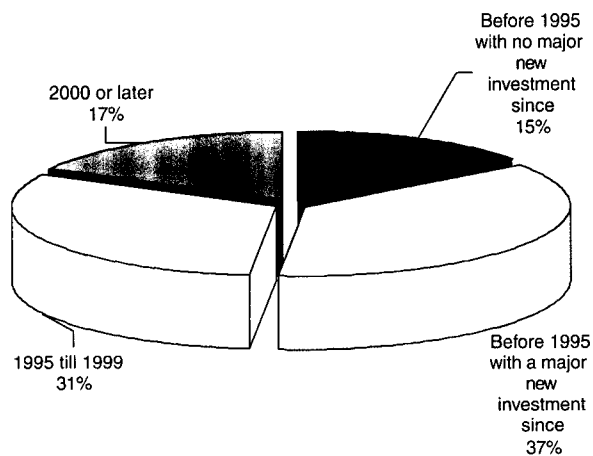
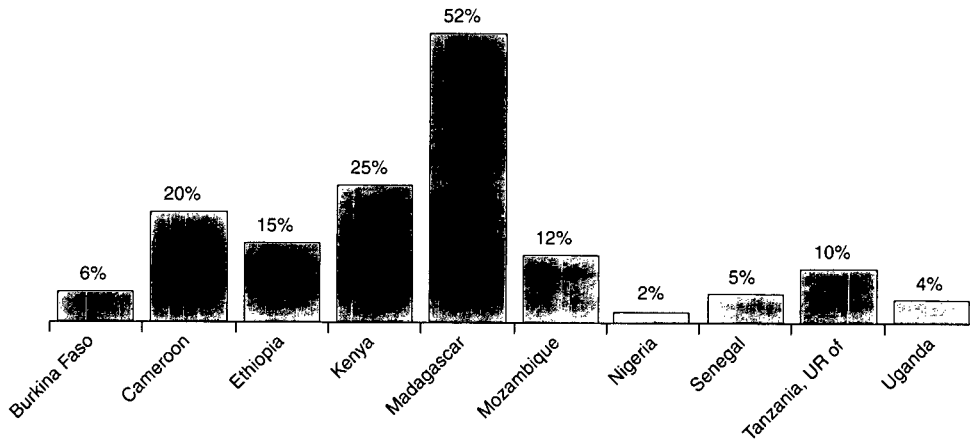
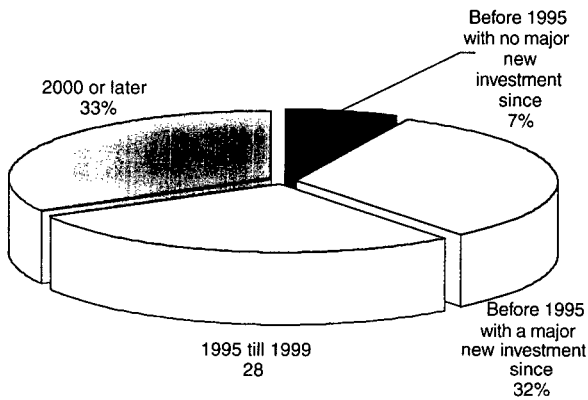

Figure 3.3. Profile of large exporters

Percentage of large exporters in the country



Large exporters by period of investment



Large exporters by mode of entry

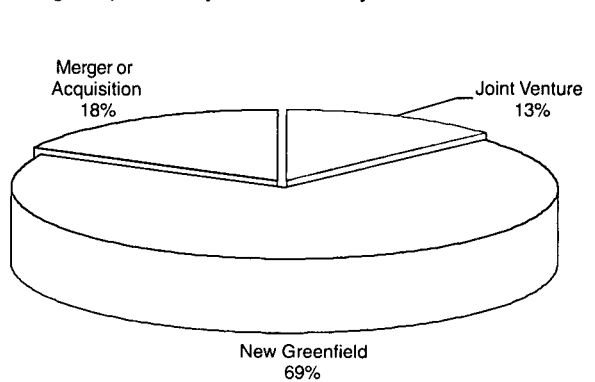

Large exporters by employment

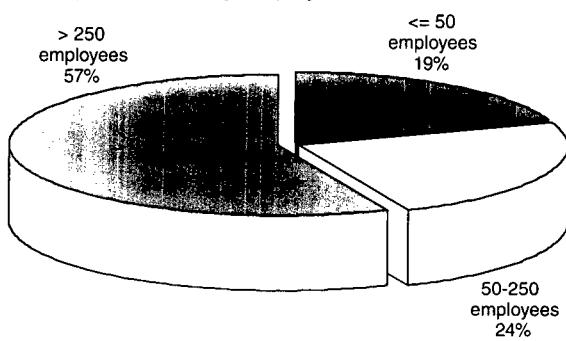

Large exporters by technology intensity

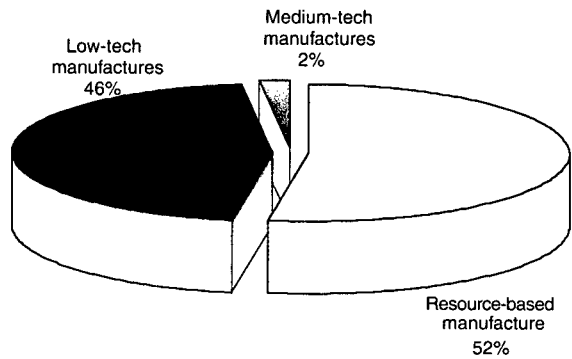

Top Sectors: Wearing Apparel (28%), Agriculture (23%), Food and Drink (13%)

FOREIGN DIRECT INVESTOR PERCEPTIONS IN SUB-SAHARAN AFRICA

In addition to these three main investor profiles, a consistent check for a variety in responses was performed by crosschecking results for the following important sub-groups of respondents.

- High intensity exporters versus low intensity and non-exporters. Export intensity is defined as "percentage of annual sales that is destined for exports".
- Manufacturers versus non-manufacturers
- Joint ventures versus greenfields and mergers and acquisitions
- Resource based and low-tech versus medium- and high-tech investments
- Respondents by country of investment, year of entry, country of origin, size and industry (for distributions see above)

Table 3.1 Summary of other important respondent categories (percentage)

	Burkina Faso	Cameroon	Ethiopia	Kenya	Madagascar	Mozambique	Nigeria	Senegal	Tanzania, UR of	Uganda	Total
Production	54	55	76	57	76	53	76	54	85	73	67
Non-Production	46	45	24	43	24	47	24	46	15	27	33
Total	100	100	100	100	100	100	100	100	100	100	100
Joint Venture	4	11	62	23	4	33	55	0	35	20	25
New Greenfield	80	75	29	52	79	46	38	86	51	67	59
Merger or Acquisition	16	14	10	25	17	21	7	14	14	13	16
Total	100	100	100	100	100	100	100	100	100	100	100
No answer	30	27	16	9	9	7	22	32	9	23	16
No exports	37	28	60	25	24	66	61	24	46	38	42
Exports less than 10% of annual sales	6	8	2	7	9	1	4	26	14	12	8
Exports between 10 and 25% of annual sales	11	8	4	14	2	3	2	8	8	15	8
Exports between 25 and 50 of annual sales	7	5	2	17	1	8	6	3	8	3	7
Exports between 50 and 75% of annual sales	4	3	2	3	2	2	2	3	5	5	3
Exports more than 75% of annual sales	6	20	15	25	52	12	2	5	10	4	16
Total	100	100	100	100	100	100	100	100	100	100	100
Resource-based manufactures	28	82	49	44	24	58	26	47	43	56	44
Low-tech manufactures	41	9	27	35	69	33	49	18	40	34	39
Medium-tech manufactures	31	9	16	21	5	7	19	35	15	10	15
High-tech manufactures	0	0	8	0	2	2	5	0	1	0	2
Total	100	100	100	100	100	100	100	100	100	100	100

Investors' performance and future outlook

This chapter focuses on the investor experiences and investment performance in each country. It also reviews the relations between future investment plans and past performance and experience in each country.

Investors' experience in each country

Investors were asked if their investment had performed to expectations in the last three years. The results are summarized in Figure 4.1. The largest group consisted of investors that considered their investment to be in line with expectations. For 16% of respondents, their investment was above expectations and for a rather large share of the investors (40%) their investment was below expectations. These results appeared to be largely similar for either market-seeking, resource-based and export-oriented investors.

Furthermore, no distinction was observed between investors that entered as a joint venture compared to greenfield or merger and acquisition.

Figure 4.1. Has your investment performed to expectations in the last three years?

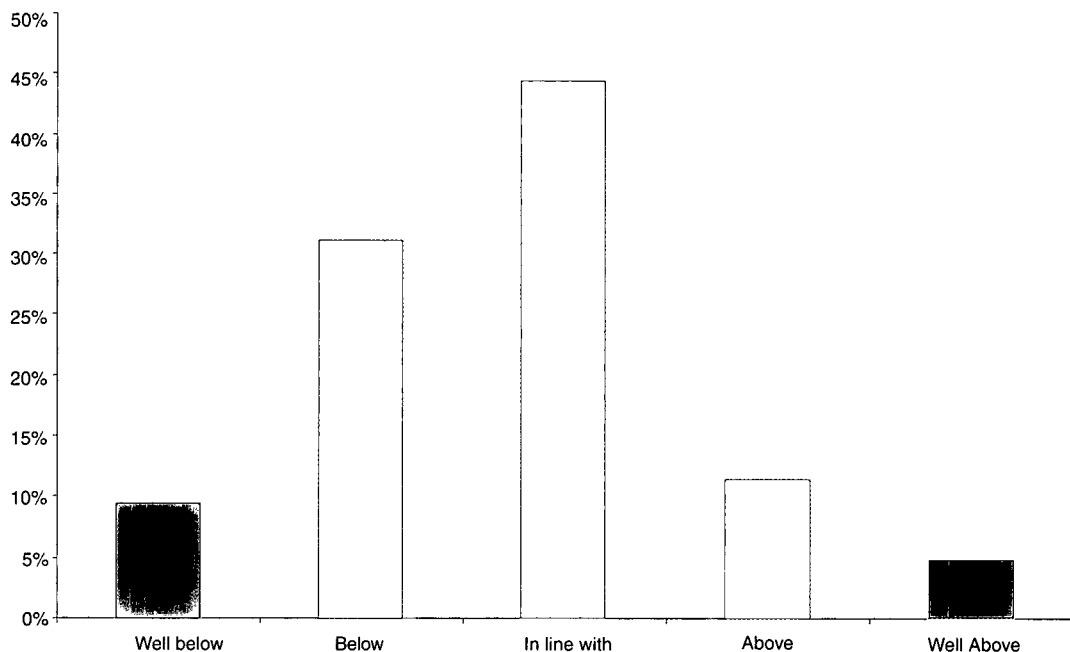
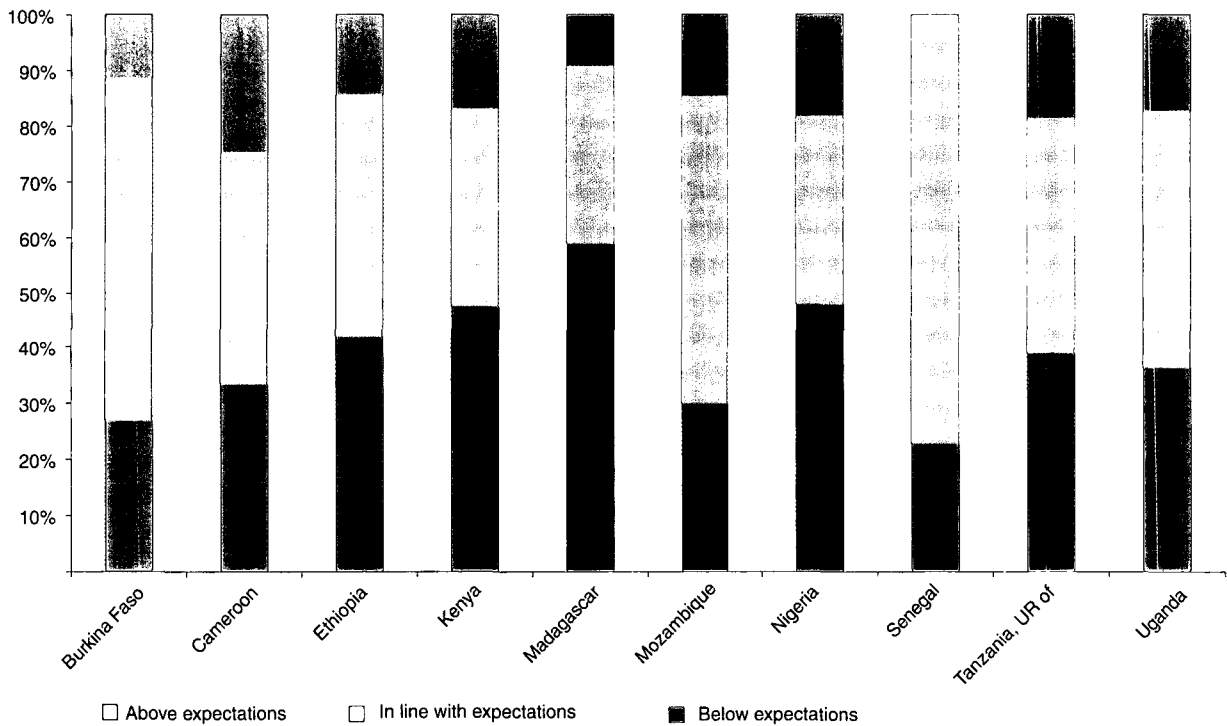

Figure 4.2. Distribution of foreign investors by performance of their investment in the last three years per country



Overall, investors in Burkina Faso, Mozambique and Senegal were most satisfied with the performance of their investment. In the case of Senegal none of the investors mentioned they were performing above expectations, but at the same time this country had the lowest percentage of companies performing below expectations.

Madagascar was the only country where more than 50% of the investors felt their investment was performing below expectations. Particularly export-oriented investors in the food and drink and wearing apparel sector were reporting disappointing performance of the investment. The poor performance of investments was mainly seen as the result of factors related to the political crisis that emerged after the elections of December 2001, which left the country struggling with general strikes and unrest for most of the year 2002.

To compare actual performance with perception, respondents were also asked the approximate the percentage increase in total annual sales compared to the previous fiscal year. This question was cross-checked against their subjective evaluation of how the investment has performed. No significant rela-

tion was found between recent sales performance and current evaluation of how the investment has performed in the last three years. The only difference found was between the two extremes: 60% of the companies with falling sales indicated that the investment was performing below expectations, whereas 'only' 30% of the companies with more than 20% sales growth found the investment was performing below expectations.

In a separate open question, the respondents were asked to provide the main reasons for their evaluation of the performance of their investment. Foreign investors indicating that the investment had not performed to expectations mainly mentioned factors related to:

- Economic/political stability
- Market developments
- Transport and infrastructure issues
- Taxation issues
- Unfair competition
- Poor availability of raw materials
- Lack of investment funding
- No support from government/lack of transparency/too much administration

Foreign investors reporting their investment was performing above expectations mainly indicated factors related to:

- Market developments (by far the main reason)
- Labour cost and labour availability
- No competition

Further analysis of those indicating disappointing investment performances was done with a cross-check of their evaluation of developments in important location criteria. The study found a significant correlation between evaluation of labour cost "getting worse over time" and investment evaluation of "well below expectations". The following factors were most frequently mentioned by these investors as important in their location decision but having deteriorated since their decision to invest:

- Economic stability
- Local market conditions
- Labour costs developments

Sectors with more than 50% of the investments performing below expectations are textiles, wearing apparel, pharmaceuticals and transport equipment. This is very significant since these are some of the most export intensive, high employment generating or high technology content sectors. Sectors performing particularly well in sub-Saharan Africa are agriculture, basic metals, base chemicals and financial intermediation.

Survey respondents were asked what their preferred location would be today for investments to serve African markets in case they would still have the freedom to decide on the optimal location of their current operations. 51% of respondents who answered the question (there was a non-response of 49%) would reinvest in their current country location. This means that 49% found their current location was not the optimal location anymore to serve African markets. The results did not differ when comparing for the different subgroups that were defined. Only investors in Madagascar were relatively less satisfied and in Mozambique more satisfied with their current location choice compared to the regional average. Neither was there a significant relationship with the sales evolution compared to the previous fiscal year or with the evaluation of their

Figure 4.3. Distribution of respondents by performance of the investment per sector category

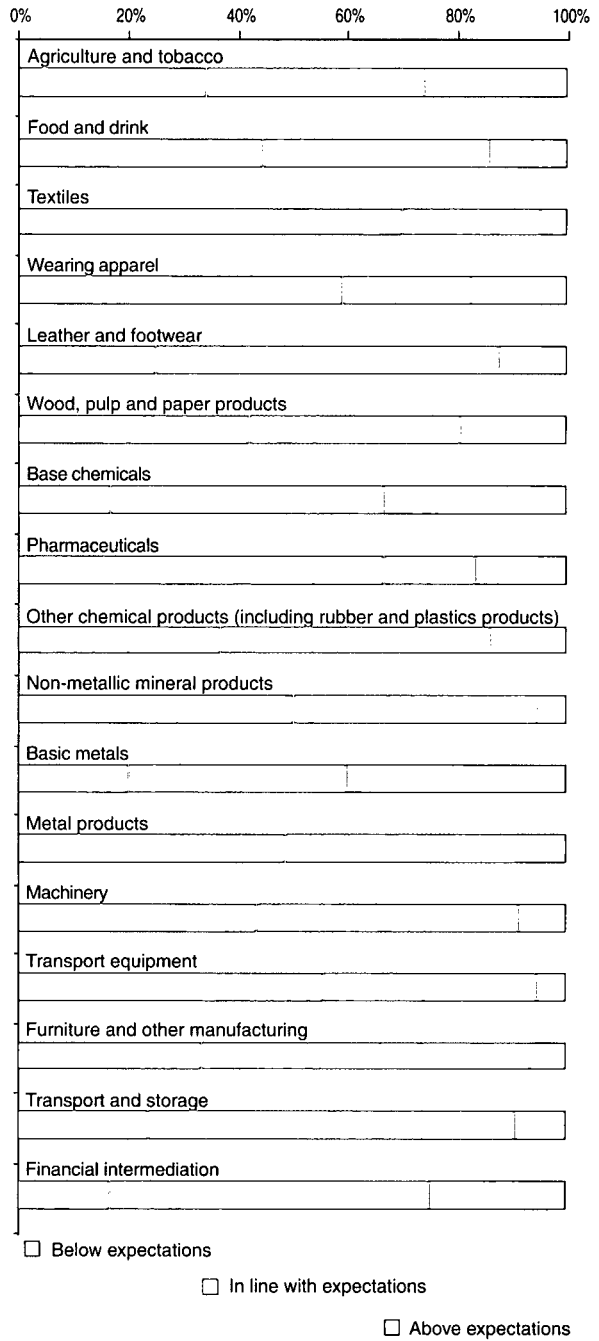

current location. Interesting to know is where those 49% of investors that would choose another location would like to go if they could choose their preferred location today. This would give some indication of the new emerging markets in sub-Saharan Africa. This topic is further discussed in the next section "future outlook".

Future outlook

This section deals with respondents' expectations in terms of sales growth, employment growth, investment plans, future services required from IPA, and current preferred location for serving the African markets. The main focus is on understanding to what extent existing investors expect their operations to perform well over the next few years and which countries in sub-Saharan Africa are emerging as preferred locations to serve African markets.

Sales and employment growth

Overall, over 50% of companies in the survey expected some employment growth over the next three years. One-third of the respondents expected no growth in employment and about 13% were expecting to reduce staff.

A relatively larger proportion of foreign companies based in Ethiopia, United Republic of Tanzania and Nigeria were expecting employment growth rates. Kenya had the highest share of companies expect-

Figure 4.4. Distribution of respondents by expected employment growth

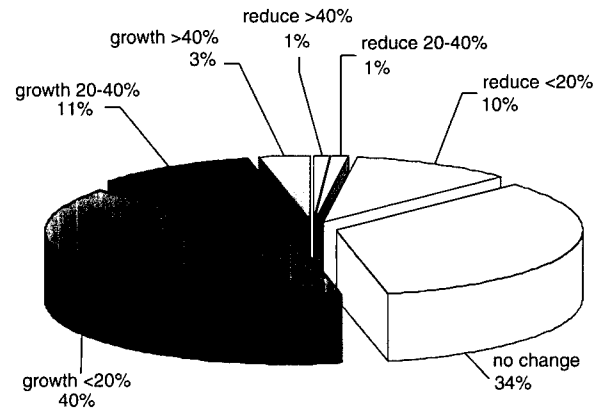

ing staff reduction over the next three years. In Madagascar, a relatively higher share of companies was expecting a significant staff reduction of over 20%. In Senegal, not one of the respondents expected to reduce staff.

An explanation for the anticipated dynamics in employment by country as shown below can be found in the main sectors of business of the respondents in each country. In the next three years, espe-

Figure 4.5. Distribution of foreign investors by expected employment growth per country

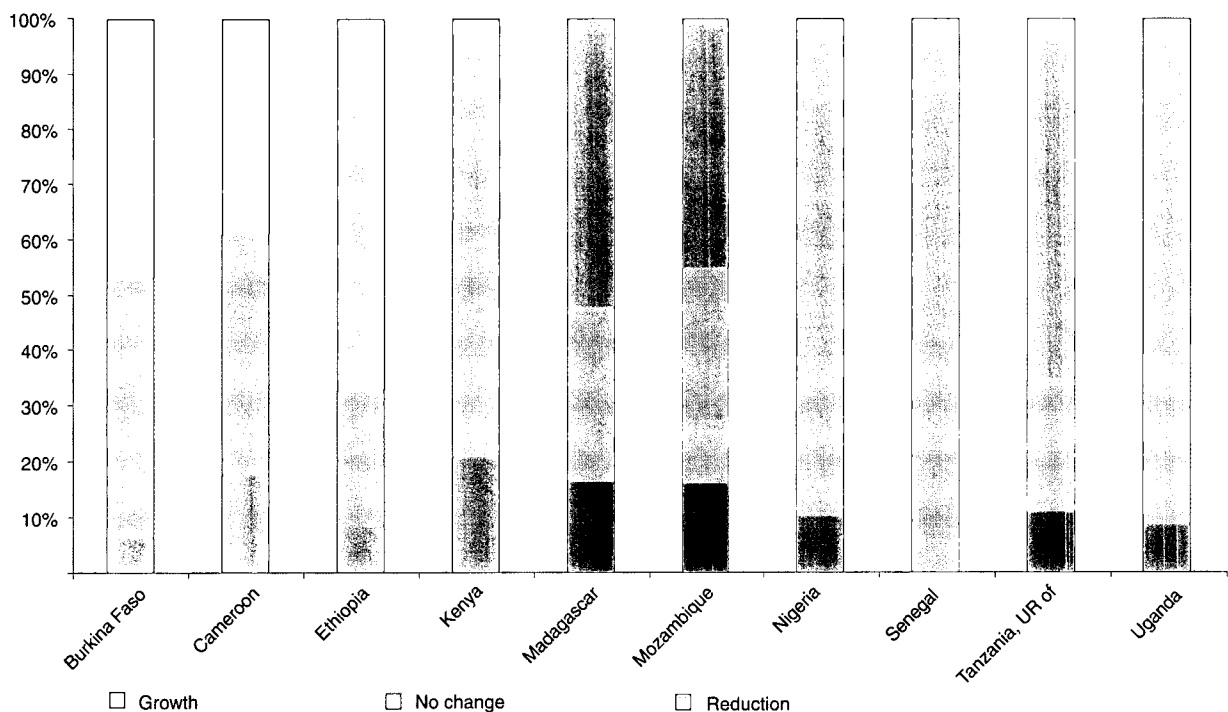
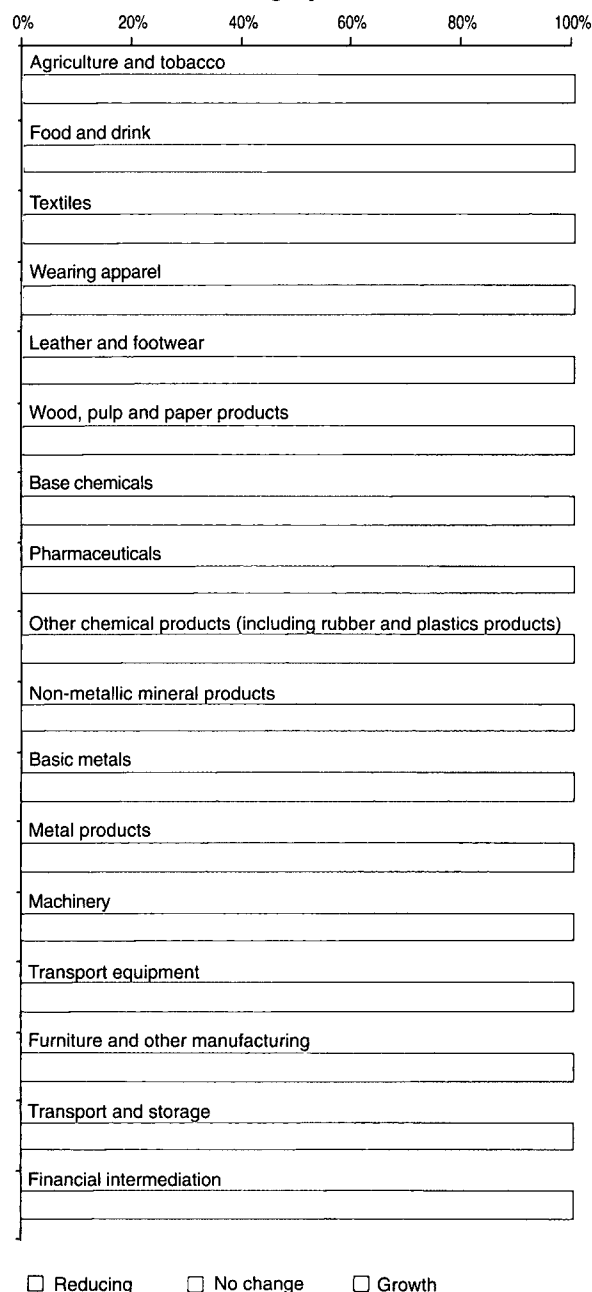

Figure 4.6. Distribution of respondents by expected employment growth per sector category



cially leather and footwear, textiles, wearing apparel, basic metals and metal products are anticipating employment growth.

Analysis of sales growth figures for the last few years among the respondent population provided very useful insights into individual sector performance. In addition, it helped identify opportunities and threats resulting from the financial health of the foreign investor base in each country.

Many respondents were rather optimistic about their development of sales in local markets. Less than 6% expected falling sales and only 12% anticipated no sales growth. The remaining 82% expected sales to grow. Almost 30% of respondents were expecting solid sales growth figures of 13+% in the next three years.

When considering local sales in individual countries, the highest anticipated growth figures were observed in Nigeria (53% anticipated more than 13% sales growth) and Madagascar (38% anticipated over 13% growth). The expectations in Cameroon were less positive: 15% anticipated falling sales and 19% anticipated no growth.

A relatively large share of particularly the large exporters (29%) anticipated high global sales growth figures (>20% sales increase). Nearly half of the wearing apparel companies with global sales anticipated a global sales growth of more than 20%, clearly indicating the healthy prospects for this sector in Africa. This explains the good performance of Madagascar.

Table 4.1. Expected sales growth per annum over the next three years (percentage)

	Falling sales	No growth	1-3%	4-7%	8-12%	13-20%	Over 20%	Total
In the country	6	12	16	18	18	12	18	100
In sub-Saharan Africa	3	12	19	22	19	12	13	100
Globally	6	17	20	10	16	9	22	100

Figure 4.7. Distribution of respondents by sales growth (compared to the previous fiscal year) per sector

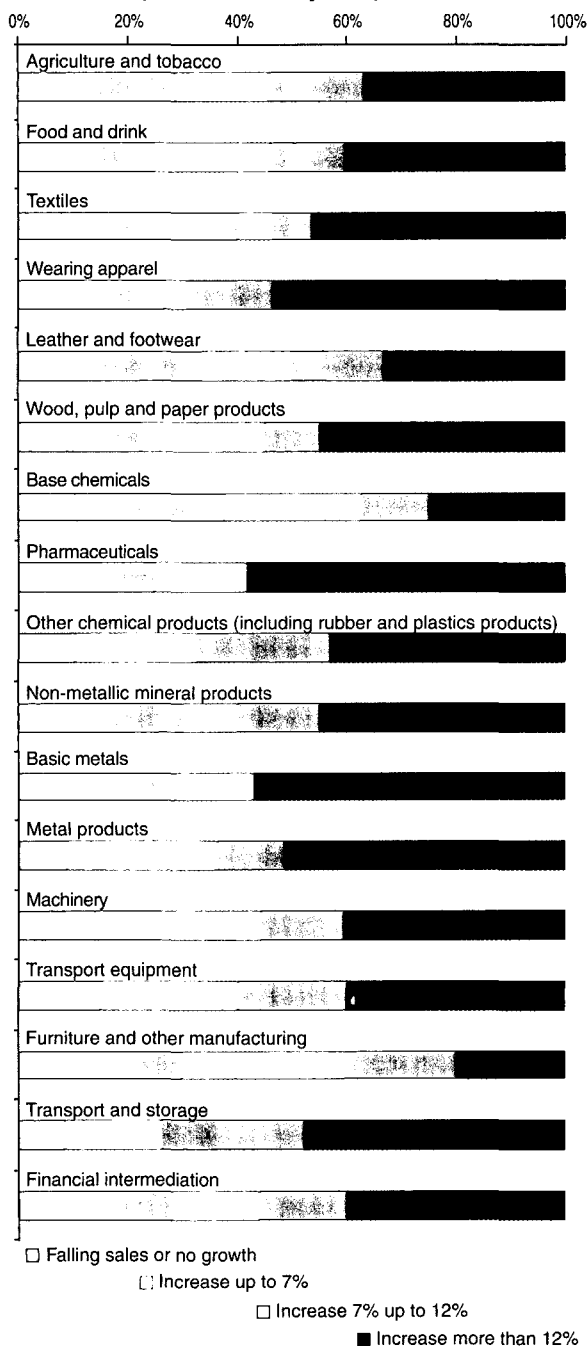

Expected sales and employment growth figures will be checked against several other variables such as entry date, evaluation of current performance and future investment expectations. The following observations are noted:

The future outlook for eight key sectors in terms of employment and sales growth in the next few years looks quite diverse. No significant relationship was found between expected sales growth and employment growth.

Based on the Graph 4.7 it appears that only the agriculture sector is expected to be a major job creator in the next few years. Particularly when considering the fact that companies in this sector already are relatively larger in size compared to other sectors. 'Next best' in terms of job creation would be other chemicals and wood, pulp and paper products where about 10% of the respondents expect to expand staff with at least 20%.

Overall sales growth expectations for these sectors were solid, but do not necessarily imply job growth. A large share of the financial intermediation sector is expecting strong sales growth figures, but none expect to expand staff with more than 20% over the next few years. Wearing apparel and agriculture do both rely on global and local markets for their sales growth, whereas other sectors mostly rely on local market opportunities.

Key findings of further research on the expected growth figures are:

- No variation in growth figures are observed when cross-checked for technology intensity. Only resource-based manufacturers expect less regional sales growth.
- Investors in agriculture, financial intermediation and other chemicals were most positive in evaluation of investment performance and also in future sales growth expectations. However wearing apparel is anticipating strong sales growth rates, whereas the overall evaluation of the investment was less positive.
- Recent investors anticipate the highest employment growth figures (established in 2000 or later). This group was clearly still expanding and more than 70% were anticipating employment growth.
- No difference in expectations could be identified between smaller and larger companies (>250 employees) in the respondent population.

Figure 4.8. Future outlook by sector

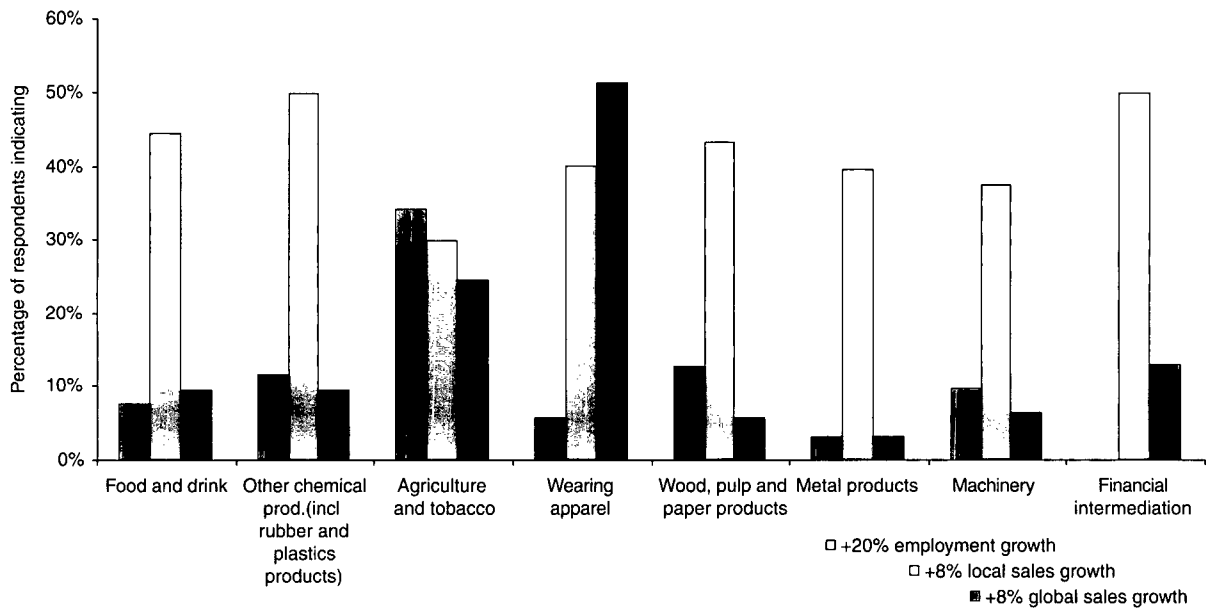

Investment plans

The majority of the investors were planning to increase their business commitment to the region.

More than 75% of the foreign investors were planning a new investment (in addition to depreciation or replacement investments) in the region.

Figure 4.9. Distribution of foreign investors by expected investment (USD) over the next three years

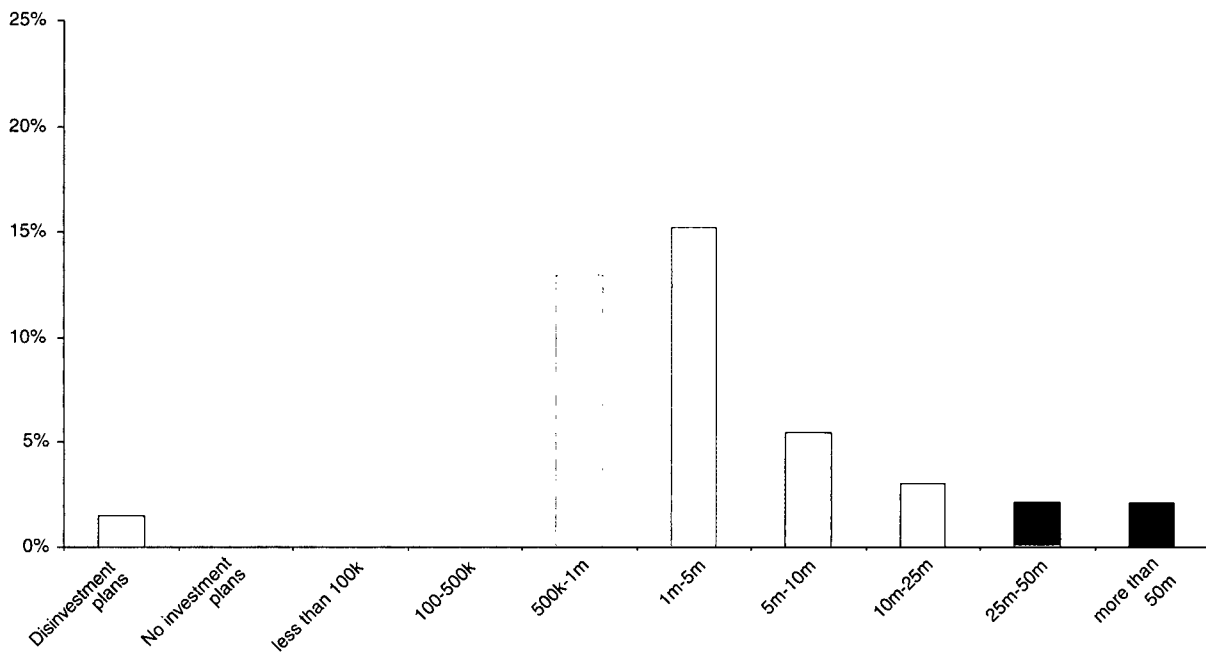

The group with no investment plans largely consists of small companies (market seeking FDI) with a current investment value of less than US\$ 500,000.

Further analysis of the data showed that companies with disinvestment plans are reducing employment, companies with no investment plans remain stable employers (overall little recruitment or reduction of staff) and companies that plan new investments are also the job creators.

The survey also asked for the main purpose of the planned new investment. Nearly 50% of respondents would invest in an expansion of an existing operation or product line. 25% would invest in a new operation or product line and 11% would consider establishing a new facility in the country. Also replacement and modernizing of existing assets was mentioned by nearly 30% of the investors. More than two-thirds of the companies planning an expansion of an existing operation or expansion with a new operation were planning an increase of staff of more than 20%.

In the next few years the respondent group is planning investments in sub-Saharan Africa of between US\$ 1.6 billion and US\$ 3.1 billion in value.

The average value of new investments announced by respondents was highest in Nigeria and Senegal and was lowest in Madagascar (see Figure 4.10 below).

Although investors in Madagascar were least satisfied with the performance of their investment, this cannot be the main reason for scoring so poorly on future expansion investments. Countries like Nigeria and Kenya also had a relatively higher percentage of investors saying their investment was performing below expectations, but still these countries are able to secure a good average amount of expansion investment per respondent. Further research and face-to-face interviews would be required to unravel the motives of investors that plan more investments while the investment is performing below expectations.

Key sectors (in terms of investment value) expanding in the next few years are:

- Non-metallic mineral products
- Basic metals
- Agriculture
- Textiles
- Transport and storage

Figure 4.10. Figure 4.10 Announced capital investments (as average respondent) per country in the next three years (in million USD)

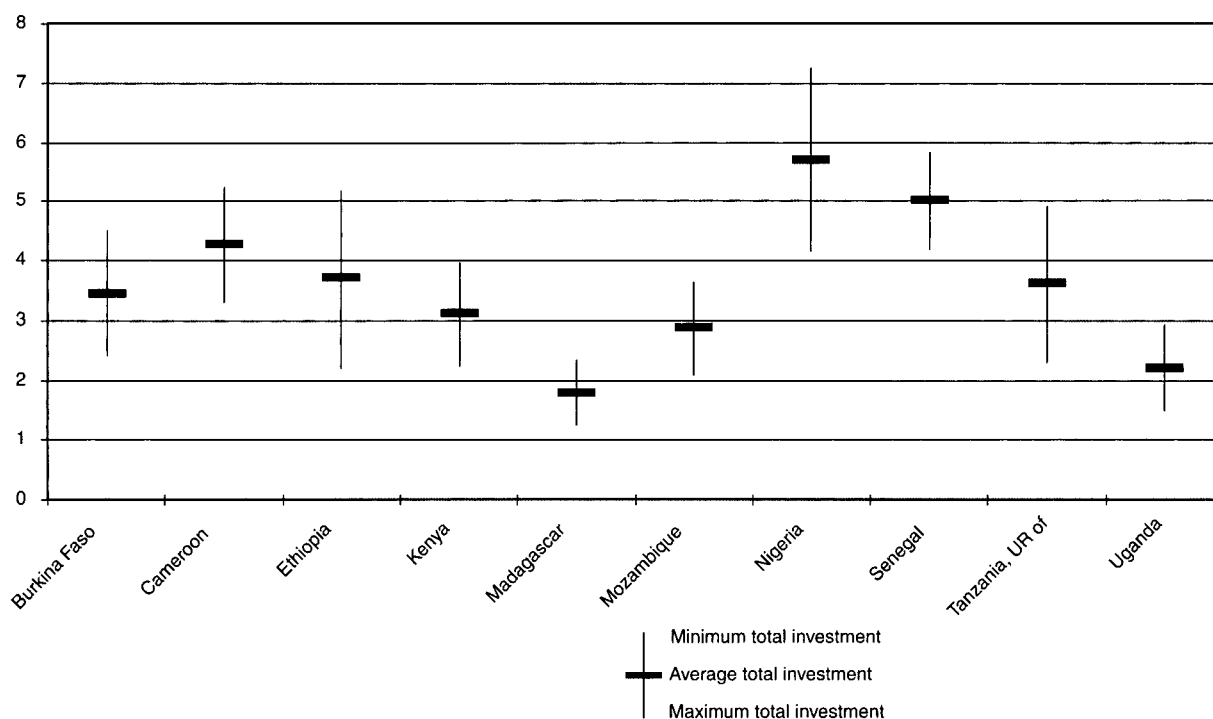
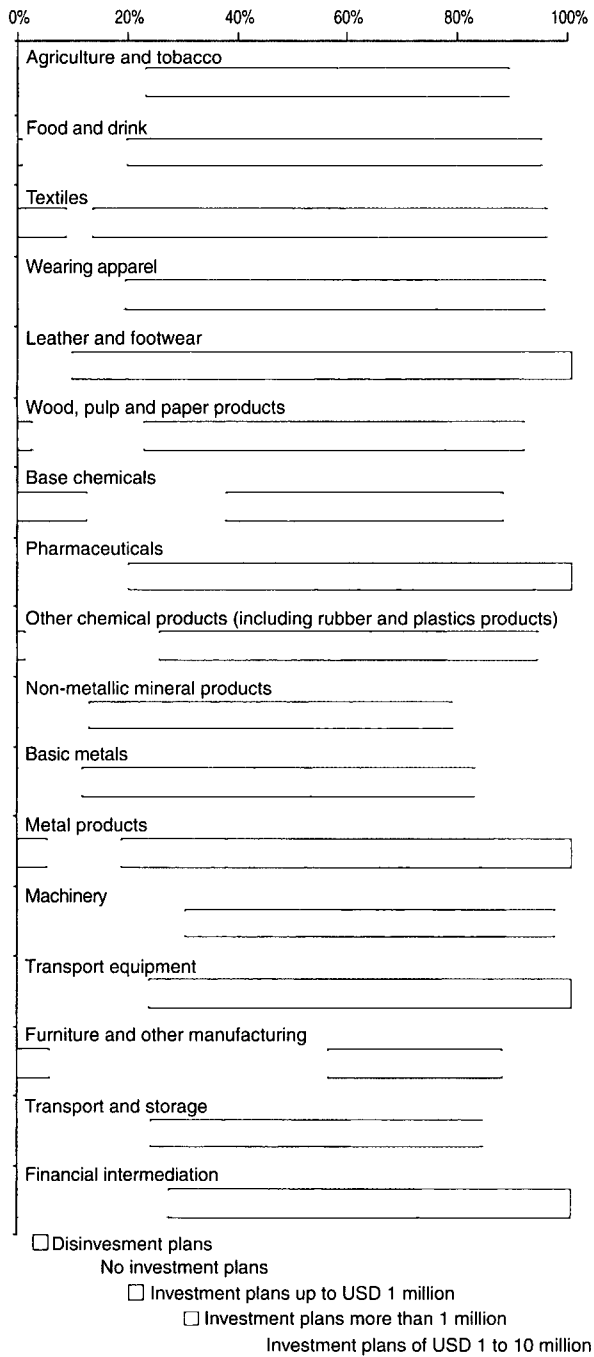

Figure 4.11. Distribution of respondents by future investment plans per sector



One of the findings earlier in the survey was that EU investors are becoming a less important source of new investment while Asia is becoming more important. Based on analysis of future expansion plans, it appears that there is no difference in future investment plans of existing investors based on region of origin.

Foreign investors established before 1995 with no major investment since had fewer future investment plans. Companies that already expanded after 1995 had relatively more future investment plans.

Part of the companies with investments that performed above expectations had relatively larger size investment plans. As shown above particularly resource-based manufacturers had relatively larger size investment plans (over US\$ 1 million). Due to the nature of the sector these companies generally require considerable capital investments.

More than half of the respondents with over 250 employees had large investment plans for the next three years confirming the observation that the larger companies are more likely to expand existing investments in the near future.

In general the large investment plans were more or less evenly distributed over all the countries under analysis except for Cameroon where the outlook was somewhat below the average.

The location factors that had the most impact on future investment plans were local market conditions and the presence of key clients and incentives. The first two location factors are mainly market and sales related. The incentives factor seems to suggest that current incentive schemes provided to the investor (such as tax reductions and duty exemptions) play an important role in an investor's decision to further expand its commitment to the country. The other important location factors have no impact on future investments. More on the implications of this is included in Chapter 7.

Nearly two-thirds of the companies with future investment plans want to be contacted by the IPA. This represents a ready target group for IPAs to hone their immediate promotion activities for future investments in the country. In terms of contribution to the design of promotion strategies for IPAs, this information is perhaps the most immediately useful and can serve as the basis for a one-year activity plan.

Performance in the past appeared to be a good indicator for future investment and growth expectations. Over 90% of the companies saying their investment performed above expectations were planning new investments in the next three years. This compared

Figure 4.12. Past investment performance against future investment plans

Has your investment performed to expectations in the last three years?

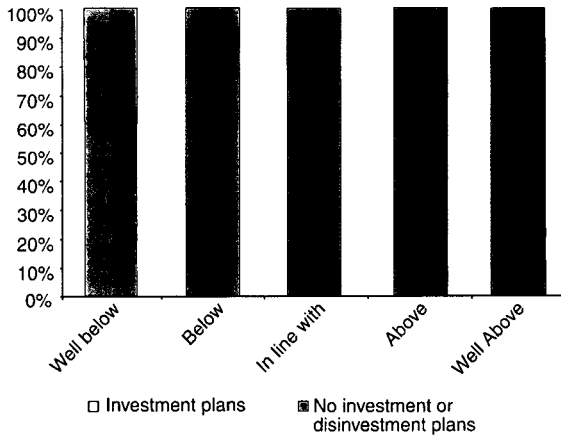
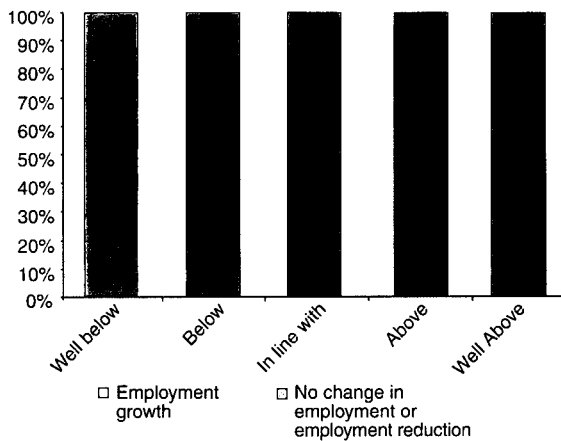

Figure 4.13. Past investment performance against employment growth plans

Has your investment performed to expectations in the last three years?



to 60% of the companies that performed well below expectations.

Comparing employment growth expectations based on investment performance, the difference in growth expectations becomes even clearer. Companies with investments that performed above expectations are planning much more employment growth compared to companies with investments below expectations.

Nonetheless, the graphs also show that past performance is not necessarily the only deciding factor for companies to consider expanding their investments. A considerable number of the companies with investments performing below expectations are still planning new investments or future employment growth.

These findings however enforce the importance of having 'happy investors' in the country. Not only are these investors important ambassadors in terms of creating positive awareness of investment opportunities in the country, they also are most important to the country in terms of employment growth and sustainability of the investment commitment to the country.

Perceptions and service needs of investors

This chapter will look into the following questions:

- What are factors critical to the investment decision-making process? What services are required from national IPAs by different categories of investors? What are their experiences with local IPA and business conditions?
- What are the post-investment experiences of these investors? What are their after-care and corporate development needs? What are their perceptions on business climate dynamics?

As explained earlier in Chapter 2, when analysing the survey findings every outcome was cross-checked against a number of important respondent categories to check for potential deviation in outcome and search for explanatory variables.

Pre-investment and investment

In this part of the analysis key findings are reported on important location factors in country selection and the support required by investors in the pre-investment phase. The first part analyses the importance of individual location factors in the location decision-making process of the respondents. More insight is given in clusters of countries typically considered by investors and how potential investors are made aware of investment opportunities in sub-Saharan Africa. This information will be particularly useful for IPAs within individual countries in their strategy development.

The second part examines what support services foreign investors would like to receive from the IPA, both in the phase of decision making as well as in the implementation phase. Moreover, it will present results on respondents' experiences with IPA services, their perceptions on business climate changes and positive externalities of their current investment and future investment plans.

Investor motivation

Different location factors are considered by investors before deciding on an investment location. It is important for IPAs to know what is the relative importance attached to the different factors by different categories of investors. The data allows a crosscheck for each specific subgroup of investors and the important location factors in the country selection can be analysed to determine which countries are typically in competition for particular investment projects. How the respondents were made aware of the opportunities in their country of investment is described in the last part.

Having analysed the specific location factors, three important motivators for investment in sub-Saharan Africa are discussed: companies coming for the local market opportunities, com-

panies coming for the natural resources and companies motivated by export-oriented production.

For the purpose of analysis in this Chapter three distinctive groups of investors were analysed based on key motivations:

- Investors in primary industries (resource-based investors)
- Investors serving local and regional markets (market-seeking FDI)
- Investors serving continental markets (export-processing FDI)

Figure 5.1 below shows the size of each of these three investment motivation categories in the survey. Market seeking FDI is the most dominant group, followed by investors in resource-based activities. Large exporters are the smallest group but its share is growing as discussed in Chapter 2.

Figure 5.1. Key investors categories in sub-Saharan Africa

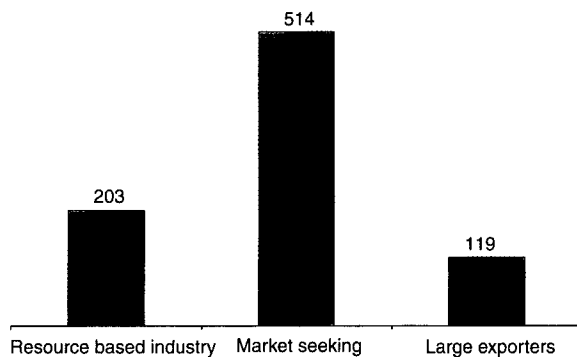

Location factors – general findings

Investors in the surveyed countries were asked to indicate the relative importance of several location factors in their investment decision making. Especially for IPAs it is crucial to have an in-depth understanding of the factors that could attract or deter different kinds of potential investors. Results of this analysis should be taken into account when assessing a country’s strengths and weaknesses and competitive position for attracting foreign investment in certain sectors.

Figure 5.2 provides an overview of the importance allocated to different location factors by investors

during the location decision process. The red line shows the percentage of respondents that consider the factor as ‘crucial’. The blue line shows the percentage of respondents that considered the location factors as either important or crucial.

Business climate conditions

Political and economic stability were among the most important location factors in sub-Saharan Africa to 85% and 83% of the respondents respectively. Political stability was considered a crucial factor to 32% of the respondents and economic stability was crucial to 29% of the respondent population.

Good business climate conditions in general are strong reasons for investment. Quality of infrastructure, country legal framework and the transparency of the investment climate were all claimed as important by more than 68% to 71% of respondents, respectively.

Market conditions

The single most crucial location factor driving the investment decision making is the local market. This factor is important for about three-quarters of the respondents and indicated as crucial by a record number of respondents (35%). These figures confirm the importance of market driven investments within the African context and parallel the earlier graph showing market seekers as the largest group of foreign investors among the respondents.

Local resources

Low labour costs and skilled labour availability were the main local resources important in location selection. Some 71% and 70% of the respondents claimed low labour costs and skilled labour availability important or crucial, respectively.

Interestingly, softer location issues such as quality of life and government agency support services were among the factors that were less crucial, but were still considered important by more than half of the respondents.

For the respondent group as whole, other location factors seemed to play a less important role in

Figure 5.2 Importance of location factors in the decision process

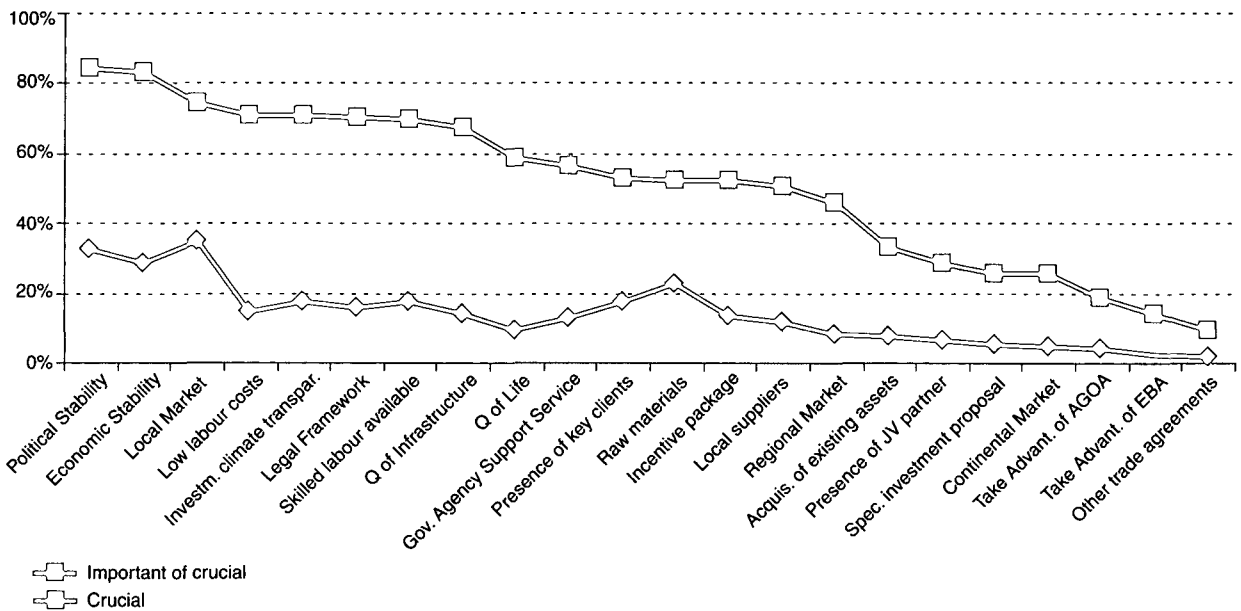

investment decision making in sub-Saharan Africa. It should be noticed however that when targeting a specific group of investors, individual location factors could come forward as relatively more important or crucial for that specific target group. This distinction is what IPAs should be very alert to. The overall distribution given above will reflect the views of the largest groups (like market seekers), and it is important to isolate the views of specific groups that may be targeted for promotion by the IPA.

Important location factors by investment motivation category

Export-oriented companies attach less importance to political and economic stability compared to local market and resource-based investors. For these export companies, access to raw materials is of much higher importance. Without the supply of raw materials these companies (mainly textiles, food and drink, wearing apparel and agriculture) cannot export. A reason why these exporters seem slightly less concerned with political and economic stability might be that low labour costs are also important to them. These exporting companies, particularly in

textiles and garments, are under strong cost pressure in order to be competitive. Therefore they might be prepared to go one step further in the trade-off between the cost of doing business and the risks associated with a certain location, in favour of costs.

For a part of this group African Growth and Opportunity Act (AGO) is crucial, whereas EBA seems crucial for only very few companies. Of the respondents exporting between 50% and 75% of their annual sales, an insignificant number attached a crucial value to this factor. However, in the export intensive group (exporting over 75% of annual sales) 11% considered AGOA as crucial. This figure still seems relatively small but when taking into account that only 34% of the export intensive respondents were established in 2000 or later, it can be concluded that for 24% of the large exporters it was a crucial factor, which makes AGOA the most crucial factor after political stability. A special section on AGOA later in this report will look at this in more in detail.

Market-seeking investors and resource-based investors show considerable similarity in terms of the relative importance they attach to location factors.

Location factors – analysis per subgroup of investors

Comparison of the importance attached to different location factors by **smaller companies versus larger companies**, shows those large companies (>250 employees) find the following factors more often crucial in their location decision making:

- Quality of infrastructure
- Government agency support services
- Country legal framework
- Transparency of the investment climate
- Acquisition of existing assets
- Importance of AGOA and EBA
- Availability of skilled labour and low labour costs (important for 82% of respondents)
- Raw materials

For smaller companies, very often the local market is more important. Previous analysis has shown that a relatively large number of the large companies are also large exporters. Exporters are able to choose between different 'export platforms', which could explain the greater importance given to country business conditions, AGOA and labour costs. Since mar-

ket proximity is a key driver for small local market-oriented companies, these issues become relatively less significant to them.

As discussed above, the local market is also relatively more important for the less intensive exporters, which are also the smaller companies. The regional market was more important for the respondents with an average export intensity. The continental market becomes a more crucial factor if the respondent is a high intensity exporter. Low intensity exporters generally target regional markets. That also explains why the presence of key clients in the country of investment is less important to larger companies.

Different sectors have different location factor priorities. Figures 3.7 and 3.8 provide insight into the location factor importance for the wearing apparel and the agriculture and tobacco sectors. These sectors were chosen to be shown separately since they belong to the main sectors for foreign investment in Africa and showed a deviant pattern compared to the average of the respondent group.

The local market, an important location factor overall, and the regional market appear to be less important for the wearing apparel sector. This could be

Figure 5.3. Importance of location factors in the decision of the wearing apparel sector

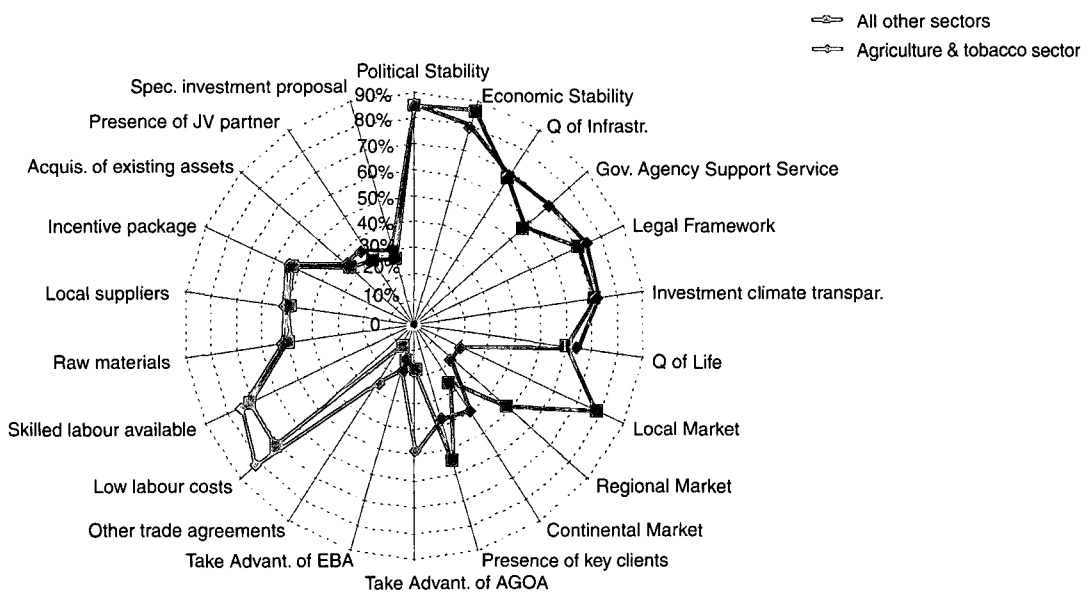

explained by the previous finding that this sector shows a relatively high number of large exporters that target global markets. Surprisingly, this is not translated into an increased emphasis on the continental market as an important location factor (indicated by importance attached to EBA). Further research revealed that the African market is also important for this group.

AGOA, which is not an important factor when considering the population as a whole, becomes much more important when targeting the wearing apparel sector. 33% of the respondents in this sector claim that AGOA was a crucial factor in location selection, whereas 51% of all respondents in this sector considered the trade agreement as important. This makes AGOA rank second when considering the crucial location factors.

Low labour cost is another factor that is given relatively more importance in the wearing apparel sector. For 83% of all respondents in the wearing apparel sector it was mentioned as important since the companies in this sector are mainly seeking low cost sites.

The local or regional market is less important for both the agriculture sector as well as the wearing

apparel sector. The presence of key clients in the country was also not mentioned as an important influence. Availability of raw materials ranks first in terms of factors considered crucial by the sector respondents.

Also in the textiles sector, this factor is of utmost importance. For 50% of respondents raw materials are crucial and the availability of good local suppliers is also an important factor for foreign textiles companies.

In the food and drink sector the local market was the most crucial factor when conducting a location evaluation. Raw materials and local suppliers are more often considered crucial for location selection in this sector compared to the average of respondents across all sectors.

For medium and high tech manufacturers the local and regional markets appear relatively more important. Resource-based manufacturers attach less importance to the presence of key clients. As one would expect, the importance of raw materials is higher for this group of respondents.

The mode of entry did not make a real difference in importance of location factors. Obviously, the presence of a joint venture partner becomes much more important for joint venture investments. It is an

Figure 5.4. Importance of location factors in the decision of the agriculture sector

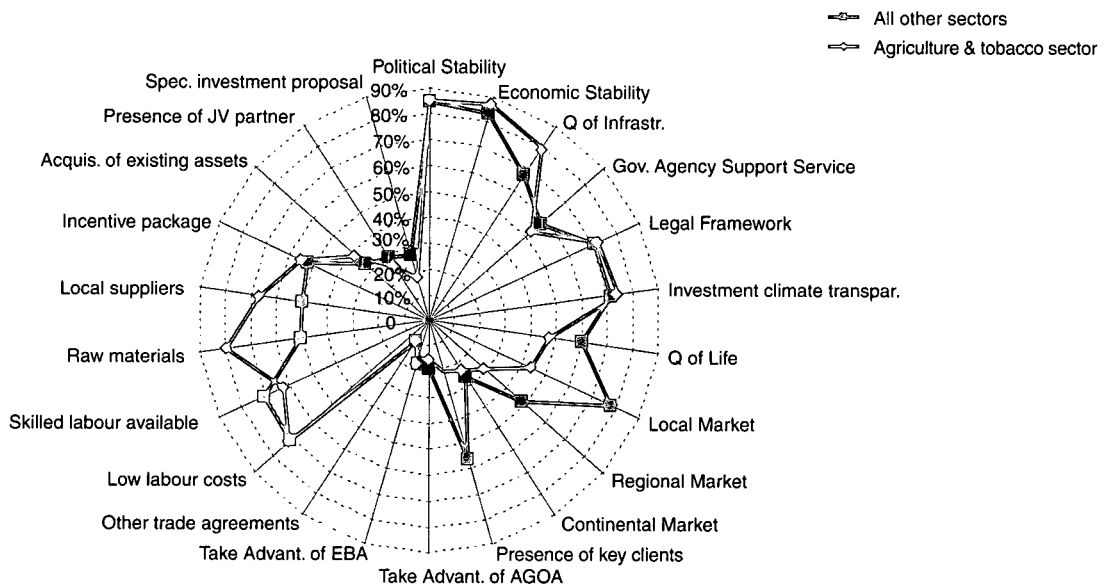

important location factor for 61% of joint venture respondents and for 19% this was crucial for the location decision. This leaves IPAs with an important task to map potential joint venture partners and investment proposals among the indigenous company base, in order to be able to rapidly respond to inquiries by foreign investors.

It can be concluded that the general picture as presented for all respondents in Figure 3.5 can be somewhat different based on the nature of the investor in terms of sector, technology or market focus. It is therefore crucial for government agencies to take those specific differences into account when developing strategies for investment promotion.

Locations considered in the decision making process

Analysis of countries competing showed that there is particularly strong competition for an investment project between neighbouring countries. Nearly 30% of respondents indicated they had considered other countries before their final investment decision. The results of the analysis of combinations of countries that are typically included in a location decision process, i.e. the countries that were evaluated against the location criteria mentioned above are interesting. In general, the location options considered were almost all other African locations. Only respondents in Madagascar and Nigeria sometimes indicated that several other non-African countries were included in the location evaluation. There were some investors that selected these countries over potentially competing sites that were not in Africa.

In Figure 5.5 all respondents that have considered other countries at the time of their investment decision are represented. For respondents that established in Eastern Africa, 60% of other location options were also Eastern African countries. The same applies for respondents established in Southern Africa of which 54% considered other Southern African options. For West-Africa this percentage is relatively lower and more other African countries outside the West-Africa region have been evaluated by the respondent investor.

Large exporters appear to be more flexible in terms of location options. A larger share of these companies indicated that countries in other African regions

Figure 5.5. Other countries considered at the time of establishment

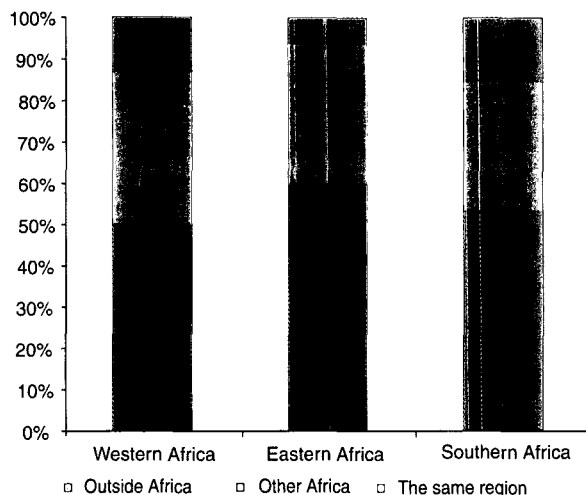

or non-African countries were included among the list of alternative locations considered. Particularly agriculture, food and drinks, textiles and wearing apparel companies sometimes indicated non-African location options.

How individual countries become part of a location selection process is discussed below.

Preferred investment location

Survey respondents were asked what their preferred location would be today for investments to serve African markets if they were not currently located in their country and still would have the freedom to decide on the optimal location of their current operations. As was indicated earlier, 51% of respondents would reinvest in their current location. It is interesting to see which countries those other 49% would choose as a preferred option today if they could do their investment over.

Figure 3.24 illustrates that in most cases other preferred locations would still be in the same region. A typical finding was that 24% of Kenyan companies would choose Tanzania whereas 35% of the United Republic of Tanzanian companies would choose Kenya if they could decide on the location today. For companies located in Eastern Africa today, however, Southern Africa was also a preferred region. This was mainly dominated by one country, South-

Figure 5.6. Distribution of the respondents by preferred location

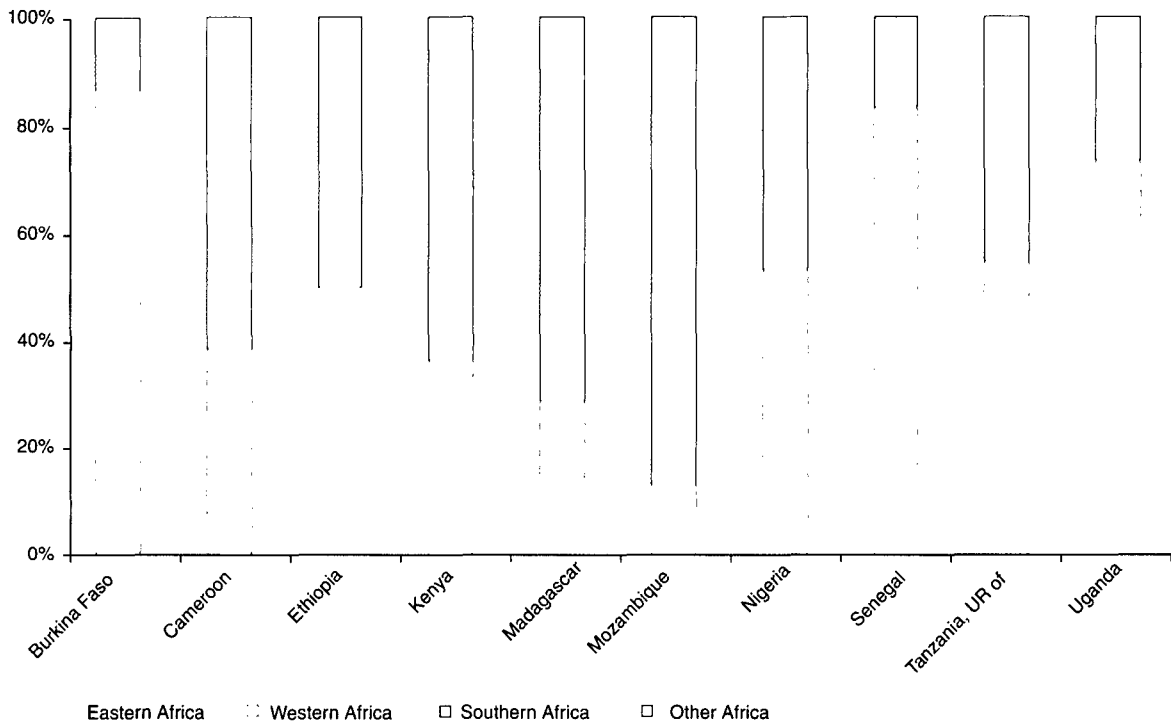

Africa, which is by far the most popular country overall.

Analysing the respondents by subgroup, it seems that in the agriculture and tobacco sector, the basic metals sector and transport and storage sector investors would more often choose their current location again.

Investors in Mozambique indicated the least tendency to move to another location (perhaps due to their proximity to their main market, South Africa) and those in Madagascar showed the highest tendency most likely due to the serious political crisis that has hit the country recently. (Possibly also reflecting the highest level of export-oriented, extremely mobile investments that continuously assess the comparative costs in competing locations and are least tied down to a location through resource dependence).

Respondents were also asked for the main reasons why they would stay in their current location or rather choose another location if they still had the freedom to decide. The typical answer pattern was highly related to the importance of each location factor in the respondent's location decision. Reasons

frequently mentioned were economic and political stability, quality of infrastructure and local market. Having a good understanding of why investors would like to stay in the country and why other investors would choose another location is crucial for IPAs in developing a country-specific Strengths, Weaknesses, Opportunities and Threats (SWOT) model. This will be analysed further in the Chapter on implications for IPAs.

Promoting awareness of investment opportunities

It is crucial for individual countries to create awareness of investment opportunities in the minds of potential investors. Since this can be a costly exercise, it is of the utmost importance to identify the mechanisms through which existing investors became aware of investment opportunities in sub-Saharan countries.

In the survey, the respondents were asked to indicate how they were made aware of investment opportunities in their country. The results of the response to this question are shown in Figure 3.10

Figure 5.7. Analysis of how investors were made aware of investment opportunities

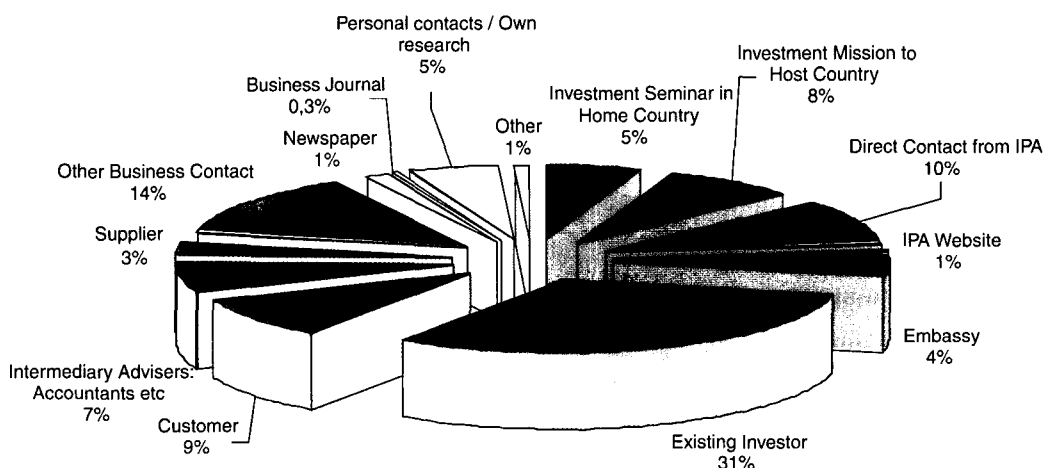

below. It became clear that almost two-thirds of all investors cited business related contacts as the most significant influential factor in how they were made aware of the investment opportunity in that location.

Existing investors were the key information source for nearly one-third of all the respondents. Customers, suppliers and other business contacts were the other sources in this group of business connections.

About 28% of respondents were made aware of the investment opportunity thanks to investment promotion related activities: 10% through direct contact from the IPA, 8% through an investment mission to the host country and 5% by an investment seminar in the home country. The embassies were responsible for 4% of respondents.

Analysis was conducted to see if the responses varied for specific subgroups of respondents.

The only relevant difference was at the country level. Investors in Kenya and Madagascar were relatively more dependent on other business contacts than the average.

These results underline the importance of investor care by IPAs and the opportunities offered by working closely together with the existing investor. The implication of this finding will be discussed in more detail in Chapter 4 of this report in a detailed section on IPA strategy and after-care.

Services needed and IPA performance

The previous section showed how investors are typically made aware of investment opportunities and which location factors are crucial in their decision making process. The results showed that IPAs in sub-Saharan Africa play a minor role in the process of awareness creation.

The survey also asked respondents which services they would like to receive from investment promotion agencies to help them in their decision making process and to facilitate the implementation process once decided on the final location. First, registration of foreign investors is discussed. Afterwards, the services investors need in the pre-investment and investment stages as well as the incentives typically desired will be discussed.

Registration of FDI

One of the most common services provided to facilitate FDI is registration or certification of companies with the IPA. This survey examined if companies registered or were provided with a certificate by the IPA. If they did, the efficiency of the certification process and its importance to them is assessed.

On the basis of the response to the survey, 48% of respondents indicated they did register with the local IPA. 33% did not, 12% didn't know and 7% did not answer the question. Registration seemed to be

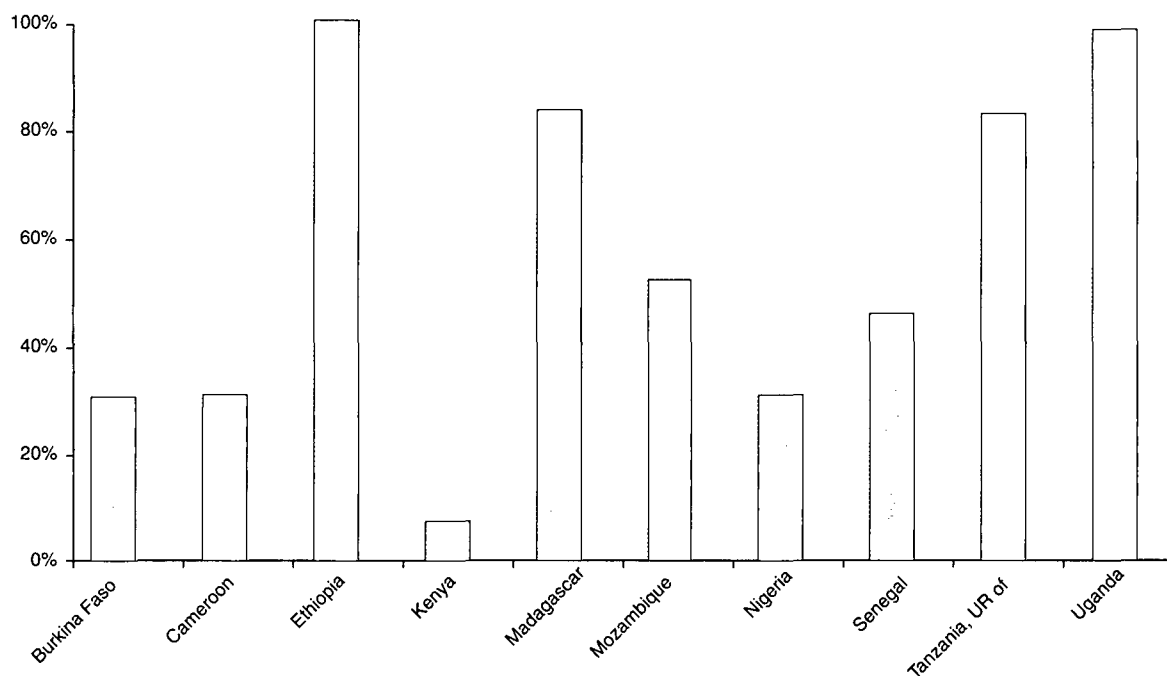
Figure 5.8. Percentage of respondents registered with the IPA

largely dependent on the way registration is organized in the different countries. Figure 3.11 reflects the percentage of respondents that indicated they had registered with the IPA (as compared to the sum of affirmative and negative answers). In Ethiopia, Uganda, United Republic of Tanzania and Madagascar, the number of registrations was very high. In the case of Ethiopia, all registrations are done via the IPA. In Kenya, Burkina Faso, Cameroon and Nigeria, a very small number of respondents confirmed having their company registered via the IPA. This would be strongly influenced by the regulatory obligations in the respective countries.

Of the companies that registered, over 90% rated the process as being good to excellent.

Respondents that had been registered or had been provided with a certificate by the IPA were asked how useful the registration or certification process has been in obtaining taxation and other benefits. Some 49% of respondents indicated it had been somewhat useful and for 41% it had been extremely useful. For only 10% of the respondents that registered via the IPA, the process was not useful in terms of obtaining benefits.

Since large discrepancies appeared in the percentage of companies registered in the different countries, further analysis was done on the usefulness of the certification process per specific subgroup since this could have important implications for activities and focus of sub-Saharan IPA's (discussed in Chapter 4).

In Burkina Faso for example, very few investors had registered via the IPA, however eight out of nine investors who did register found the registration extremely useful.

In general, large companies and production companies seemed to benefit more from registration than smaller companies and non-production companies. For more than 57% of the large companies, registration was extremely useful in obtaining other benefits, whereas for the smaller companies (less than 250 employees) only 34% of respondents thought the process was extremely useful in obtaining other benefits. A likely explanation may be the capacity of larger foreign investors to negotiate special conditions. Clearly, this is related to the fact that larger companies were found among the larger exporters who obviously are more mobile and therefore more often considering other potential locations.

For each of the countries, the usefulness of the registration process should be investigated further and, if necessary, improved. It should be decided if more attention should be paid to some specific target groups of investors. The section on implications for IPA's will analyze this in more detail.

Apart from registration or certification, many other services are required by foreign investors. The concept of the IPA as a one-stop-shop to potential investors really makes sense when analysing the needs for support indicated by the investors ranging from being aware of the opportunities in the country to after-care services.

The survey asked companies which services they requested or needed from the IPA in a pre-investment and investment stage. Out of the total, 43% of respondents (mainly those that did not register with the IPA) did not answer those two questions or marked the question as not applicable. Of the companies that had registered with the IPA, 85% indicated which services they requested or needed from the IPA in a pre-investment stage and 89% in the investment stage. Of the non-registered companies

this was only 25% and 23%. There was also a correlation with the initial point of contact of the investor in the country (how had the company originally been made aware of investment opportunities): of the respondents that had been directly contacted by the IPA, 92% requested additional services from the IPA in a pre-investment phase and 90% in the investment phase.

This leads to the assumption that many companies are not aware of the existence of the IPA or of the services they could receive. This should be investigated further on a country by country basis.

Pre-Investment

Rating of pre-investment services

Figure 5.9 shows the perceived importance of specific pre-investment services by respondent companies. The red line shows the percentage of respondents that indicated this service to be crucial. The blue line represents the percentage of respondents that found this pre-investment service *at least* impor-

Figure 5.9. Importance of pre-investment services requested or used

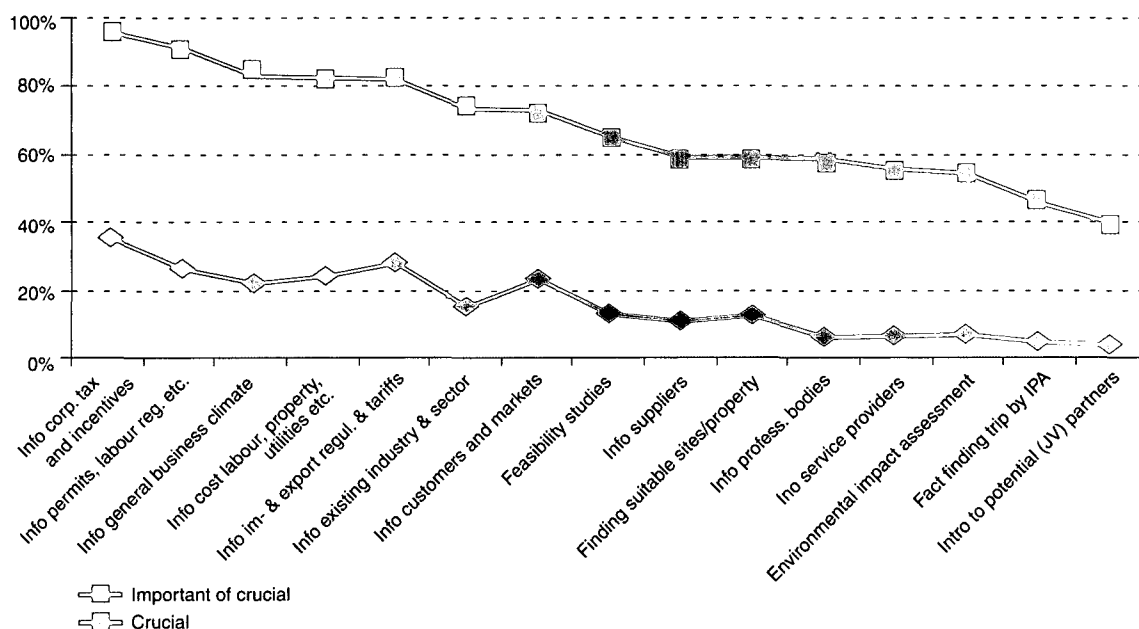

tant. Percentages are calculated against the 57% of respondents that answered the question.

Information on corporate taxation and incentives is the most important service requested in the pre-investment phase by foreign investors. Some 95% of all respondents that requested *at least* one service in the pre-investment phase rated the tax information as important or crucial. Almost equally important, pre-investment service was information on doing business in the country (permits, labour regulations, etc) followed by other pre-investment services considered important by more than 80% of the foreign investors, such as:

- information on the general business climate in the country
- information on the cost of doing business in the country (labor costs, property costs, utilities costs, etc.)
- information on importing/exporting regulations and tariffs.

Overall, the organization of a fact finding trip by the IPA and the introduction to potential partners in the country was considered least important by the foreign investors. Clearly, the latter one only applies to the small group of respondents that entered the region through a joint venture.

Important services requested by investor category: For all the three categories, market seekers, exporters and resource-based investors, information on taxation and incentives were most crucial. In addition, market seeking investors are more interested in obtaining general business climate information and information on local customers and markets. Exporters are clearly more focused on obtaining information on the cost of doing business and import and export regulations.

Implementation of a cost-effective investment promotion strategy within the individual countries requires a more detailed understanding of needs as expressed by individual investors in each country. It is very important to fully understand if differences exist between specific sub-groups of investors in terms of pre-investment services required. Again the general picture of service requirements was cross-checked against all subgroups of investors as defined in Chapter 2.

Origin of the parent: In general, the importance of the services needed did not differ widely depending on the origin of the investor, except for:

- Information on service providers and finding suitable sites, which were relatively less important for European investors. The reason for this could be that the share of new greenfield investments by European companies has been decreasing, which makes finding suitable sites less of an issue for companies from Europe.
- Environmental impact assessments were relatively more requested by African investors.

Size of the company and export intensity: Information on customers and markets was relatively more important for the smaller companies. This sounds logical since the smaller companies amongst the foreign investors were also the most local market-orientated companies. This could also explain the fact that information on importing/exporting regulations and tariffs was more important for the larger companies of which many were found among the larger exporters.

Country of investment: Information on the cost of doing business had a higher importance in Madagascar with 92% rating the service as important. Another difference was the information on importing/exporting regulations and tariffs which was crucial for more than 50% of investors in Madagascar, compared to 30% for the group as a whole. This reflects the large proportion of the respondents in the textile and garments industry based in this country. These companies are typically among the more export intense companies.

Evaluation of pre-investment services

Next to a rating of the importance of services, respondents were also asked to evaluate how well each specific service was provided by the IPA. Figure 3.13 shows the evaluation of all respondents that considered the particular service as important or crucial. Those percentages are shown on the vertical axis. The horizontal axis shows the percentage of those respondents that evaluated the particular service as provided well. The higher the service level is

placed on the graph, the more important it is to investors. The more to the right on the graph, the more satisfied the investors were with the way it was provided.

The figure shows that the most important services for the investor are also among the services that were provided best by the IPAs according to a majority of the investors answering this question. These are information on corporate taxation and incentives, information on doing business in the country and information on general country business climate. This result in itself could be considered as a very positive sign. However, still more than 40% of the respondents that found these services important or crucial thought the service was provided poorly or was not provided at all by the IPA. Overall, sub-Saharan IPA's could therefore still strongly enhance the quality of services typically requested by new investors.

Among the important services to investors that need urgent attention of IPAs are:

- Information on import and export tariffs and regulations
- Information on the cost of doing business in the country
- Information on existing industry and sectors in the country
- Information on customers and markets
- Feasibility studies

The important implications of those findings for IPAs are discussed further in Chapter 4.

Investment phase

Figure 5.11 shows the importance of specific services requested by respondent companies in the investment and post-investment phase. The red line shows the percentage of respondents that indicated the services as crucial. The blue line represents the percentage of respondents that found the pre-investment service as *at least* important. Percentages are calculated against the 57% of respondents that answered the question.

Figure 5.10. Evaluation of importance versus quality of services investors did request or use from IPAs in the pre-investment phase

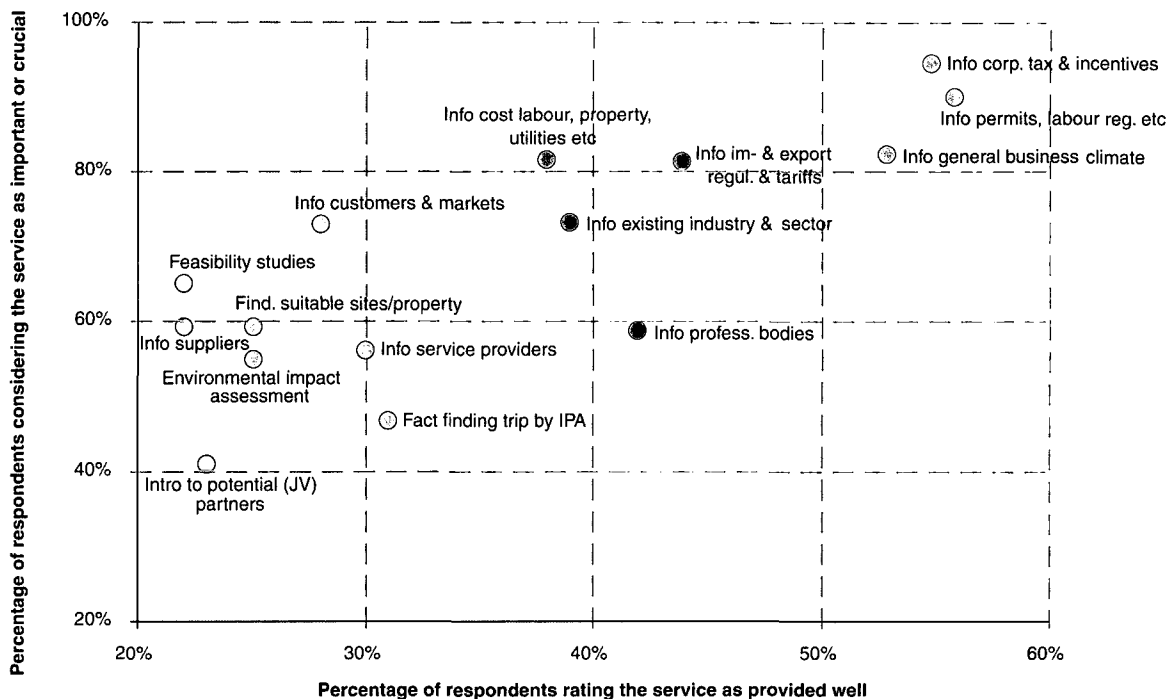

During and after establishment of the business, the most needed services for both the foreign investor group as a whole as well as for the individual categories of market seeking, resource-based and export-oriented investors are:

- company registration and licensing
- help with obtaining permits
- incentive applications

These services were considered important to more than three-quarters of the foreign investors during and after the investment decision. All other services were also considered important and were requested by 40% to 60% of the respondent group.

One noteworthy distinction is the case of market seeking investors who seem to have fewer concerns with obtaining permits than resource-based manufacturers or export processing companies. They also require less assistance with incentive applications.

Crosschecking the general picture against other sub-groups of investors provided the following results:

- Recruitment support was more important for African investors and less important for European investors. For the latter, help with office/factory purchase or lease was also less important.
- Investors attached the same level of importance to the (post-) investment services whatever their mode of entry in the country.
- No noteworthy sector differences could be identified.

Evaluation of pre-investment services

The evaluation of how well these services were provided by the IPA is reflected in Figure 5.12. This figure shows the evaluation of all respondents that considered the particular investment and post-investment services as important or crucial. Those percentages are shown on the vertical axis. The horizontal axis indicates the percentage of respondents that evaluated the services as provided well. The higher the service is placed on the graph, the more

Figure 5.11. Importance of investment and post-investment services requested or used

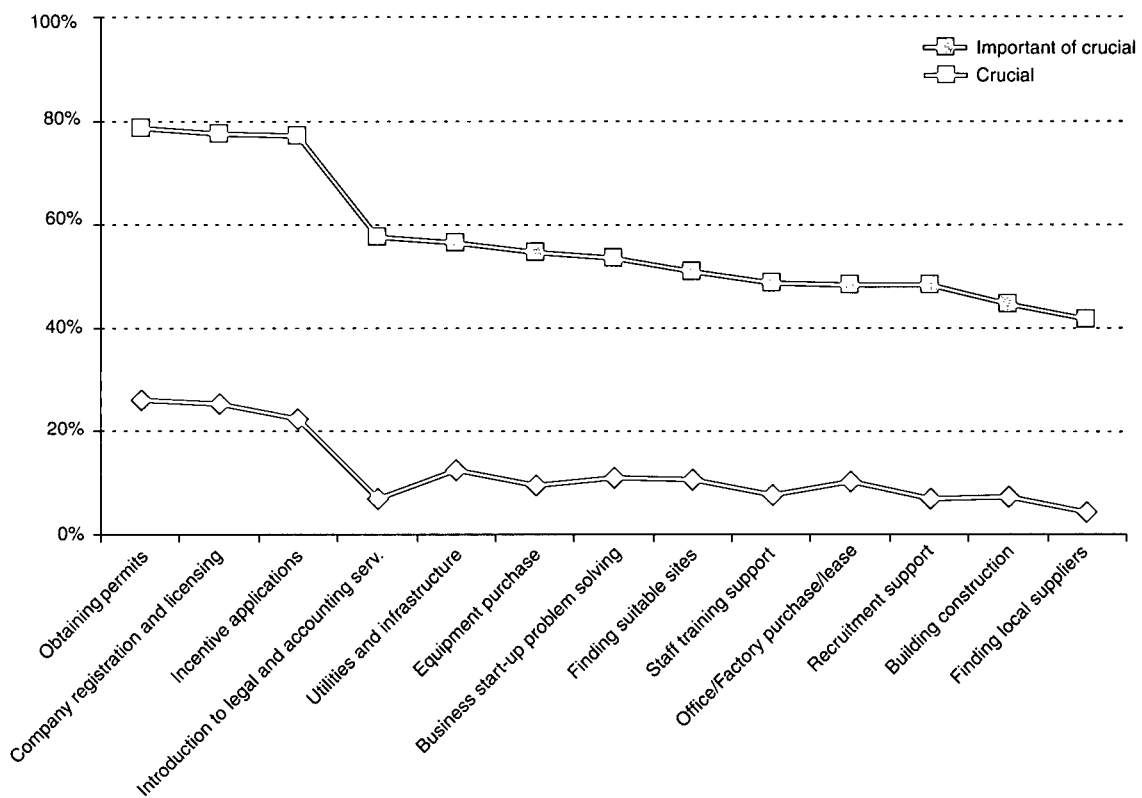

important the service was to foreign investors; the more to the left on the graph, the more the IPA could improve in the provision of this service.

The services (needed after the investment decision is made) that were rated most important by the foreign investors are also the ones that were evaluated as provided well. However, similar to the situation with the pre-investment services, a relatively large group (35% to 45% of the respondents) found the service to be provided poorly or not provided at all by the IPA.

All other services were not considered as provided well by more than 60% of the foreign investors who answered this question. Staff training support, finding local suppliers and building construction services were services that in 80% of cases were not provided by the IPA's or were not known by the investors as being provided by the IPA's. Since all of these post-investment services are important to between 40-60% of the foreign investors, there is still a lot of work to be done among sub-Saharan IPAs when it comes to post-investment services.

Incentives

As discussed before, a very large share of the foreign investors found registration with the local IPA useful in obtaining taxation and other benefits. The incentives and subsidies foreign investors were particularly interested in are shown in the Figure 5.13 below.

Duty exemptions and taxation reduction were clearly the most desired incentives for both the foreign investor group as a whole as well as for the individual categories of market seeking, resource-based and export-oriented investors. Respectively, about 85% and 88% considered those as desirable and a very high share of 69% and 74% considered them very desirable. Next in the incentive wish list of investors are bank and other interest reductions (very desirable by 58%) and import rebates (very desirable by 52%). All other incentives or subsidies were only very desirable by 25% to 40% of the respondent group. Again these percentages pertain to the 57% of respondents that answered this question.

Figure 5.12. Evaluation of importance versus quality of services investors did request or use from IPAs to facilitate their investment in the host country

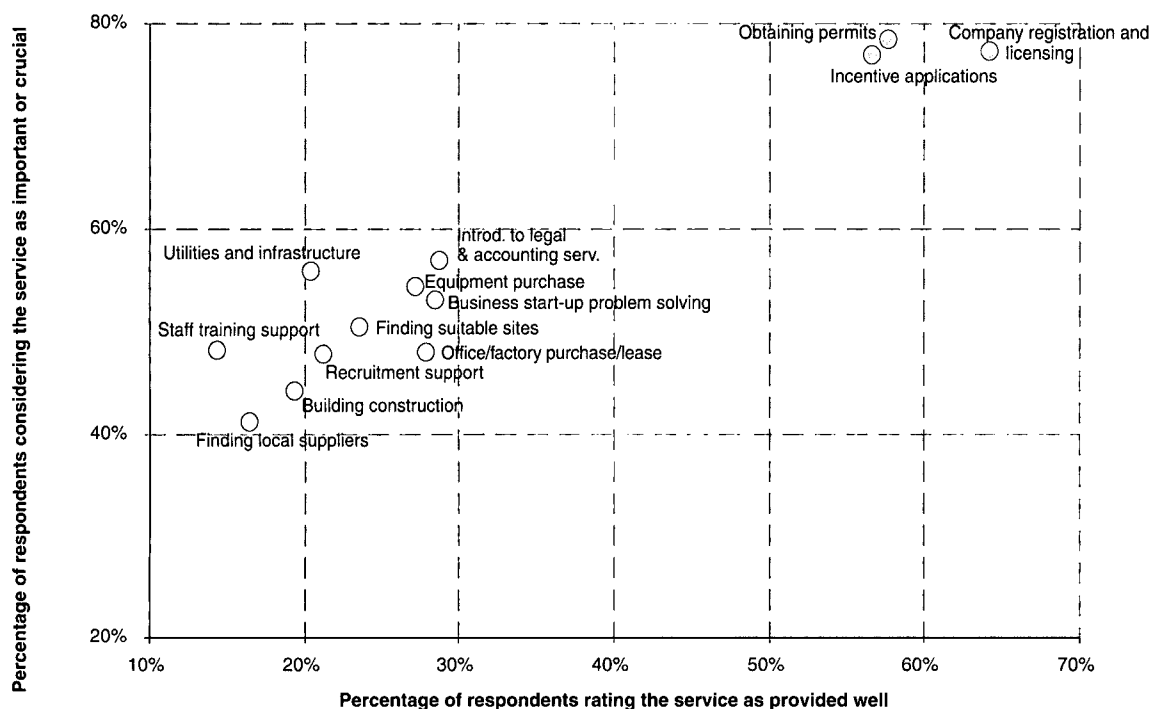
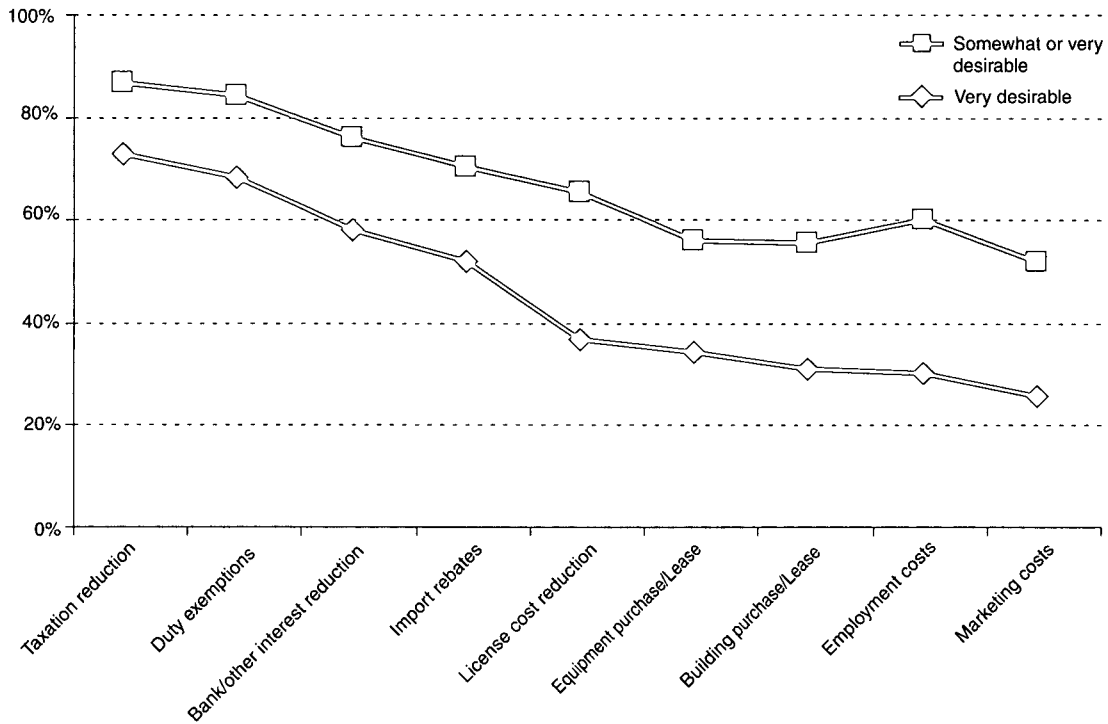

Figure 5.13. Desirability of incentives



Crosschecking those general results for the specific investor subgroups led to the following results:

- Building purchase/lease was relatively more desirable to African investors and less to European investors, who also desire less licence cost reductions.
- Bank and other interest cost reductions and subsidies to cover marketing costs and employment costs were less desired by companies established in the last three years.
- As would be expected, the larger companies indicated more often that subsidies related to employment costs were highly desirable to them. Taxation reduction seemed to be less desired by the smallest companies.

The ease in obtaining those subsidies or incentives is shown in Figure 3.17. This Figure shows the evaluation of all respondents that considered the incentives as desirable. Those percentages are shown on the vertical axis. The horizontal axis reflects the per-

centages of those respondents that evaluated the particular incentive as easy to obtain or with only some difficulties. The higher the incentive is placed, the more desirable the incentive/subsidy was; the more to the left, the more respondents (who desired this incentive) found this incentive difficult to obtain.

In general it seems that the less desirable incentives are most easy to obtain, whereas the most interesting incentives to foreign investors are most difficult to obtain.

Tax-related incentives together with bank and other interest reductions are desired by a large proportion of the foreign investors. Their experience, however, is that those incentives are more difficult to obtain.

Subsidies related to employment costs, equipment purchase/lease and building purchase/lease were easy to obtain for 18% to 24% of respondents. Subsidies related to marketing costs fall somewhere in between and are rated as easy to obtain by 13% of respondents.

FOREIGN DIRECT INVESTOR PERCEPTIONS IN SUB-SAHARAN AFRICA

The incentive package was an important location factor to invest in sub-Saharan Africa for 52% of all respondents. To respond to those investors with an attractive incentive package could be very advantageous for the success of investment promotion in each of the individual countries.

At this stage no major difference could be identified in the ease of obtaining incentives between the different subgroups. There were some indications that foreign investors in Ethiopia found duty exemptions and license cost reductions relatively easier to obtain. In Uganda, subsidies for equipment purchase/ lease would be easier. Madagascar would be advantageous in obtaining subsidies related to employment costs.

Finally the investors were also asked to provide their evaluation on the performance of the IPA in the last few years and their answers are reflected in the next graph. Overall, investors in Kenya and Madagascar most often evaluated the performance of the IPA below expectations and the IPAs of the United Republic of Tanzania and Uganda were comparatively the most appreciated.

In the case of Kenya it should be recalled (see Figure 5.8) that a very small percentage of investors were registered with the IPA, thus there is very little awareness among foreign investors about the services it provides and very little interaction. There is considerable work that needs to be done to increase the profile of the IPA in Kenya among foreign investors and develop into a more proactive agent of investment promotion and facilitation.

In the case of Madagascar these investors were mainly complaining about the quality of services provided in relation to information on corporate taxation and information on importing and exporting regulations. The fact that these services are important to the large proportion of export intensive investors in this country helps explain the negative evaluation of the IPA.

This graph seems to correspond with the graph provided in the next paragraph on the investor's evaluation of its investment performance. However, further analysis showed that IPA performance was never mentioned as a main reason for poor investment performance.

Figure 5.15. Performance of IPA in the last three years

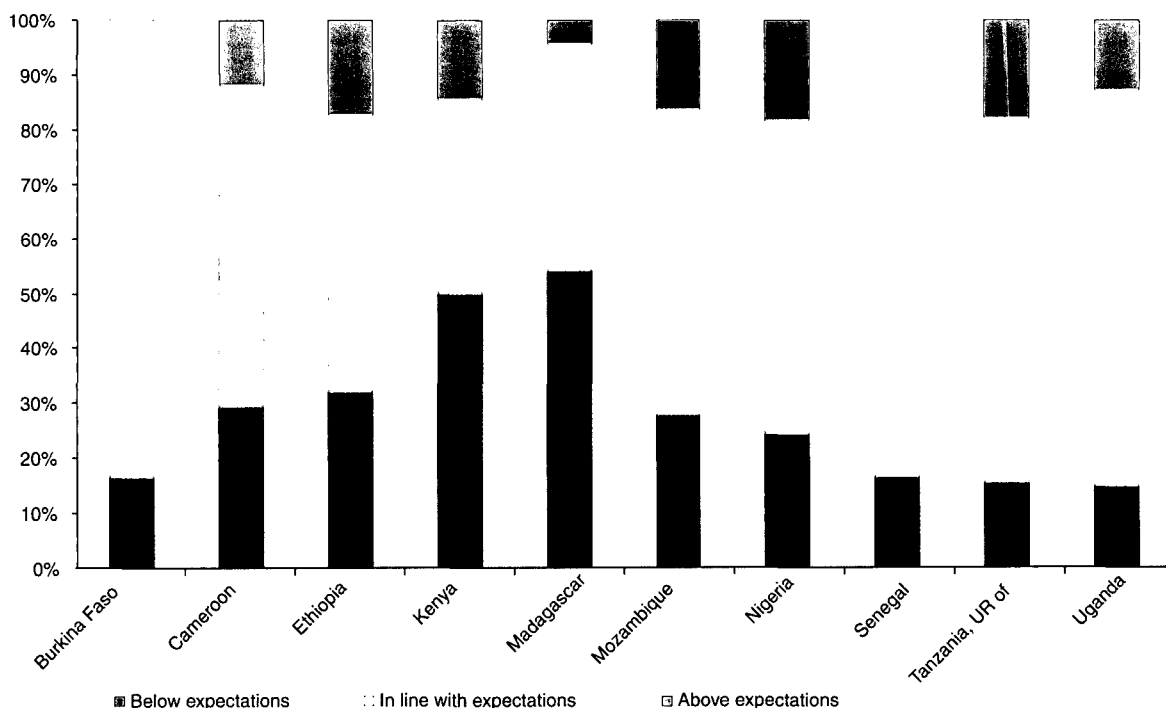

Post-investment

The experiences of the foreign investors after they established operations in sub-Saharan Africa were analysed. Questions about how elements of the investment climate have changed since their decision to invest and how their investment has performed in relation to their expectations were asked.

Business climate developments

In the previous section of this chapter, it was analysed which location factors were important or crucial for the respondent's decision to invest in one of the countries under analysis. In this section it will be analyzed to what extent the foreign investors thought those factors have changed (become better or worse) since their decision. An important location factor that has changed in a negative direction is a

⁸ Percentage of respondents considering the location factor as important or crucial.

red flag that must be addressed immediately. The size of the bubbles in Figure 3.18 below represents the importance of each location factor as analysed earlier in this chapter⁸. The horizontal axis shows the percentage of respondents that considered the specific location factor as having become worse since their decision. On the vertical axis, the percentage of respondents for which the specific location factor had become better is shown.

A very positive result is that for all location factors that were important in the location decision, the proportion of respondents that had seen this business climate condition become better was in all cases higher than the proportion of respondents that found that the condition had become worse. The best results were identified for the following important location decision factors: to take advantage of „Everything But Arms“ (EBA) and of the African Growth and Opportunity Act (AGOA), the political stability and the availability of local suppliers. 40% to 50% of respondents evaluated these conditions as better than at the time of their decision and less

Figure 5.16. Evolution of location factors since the respondent's decision

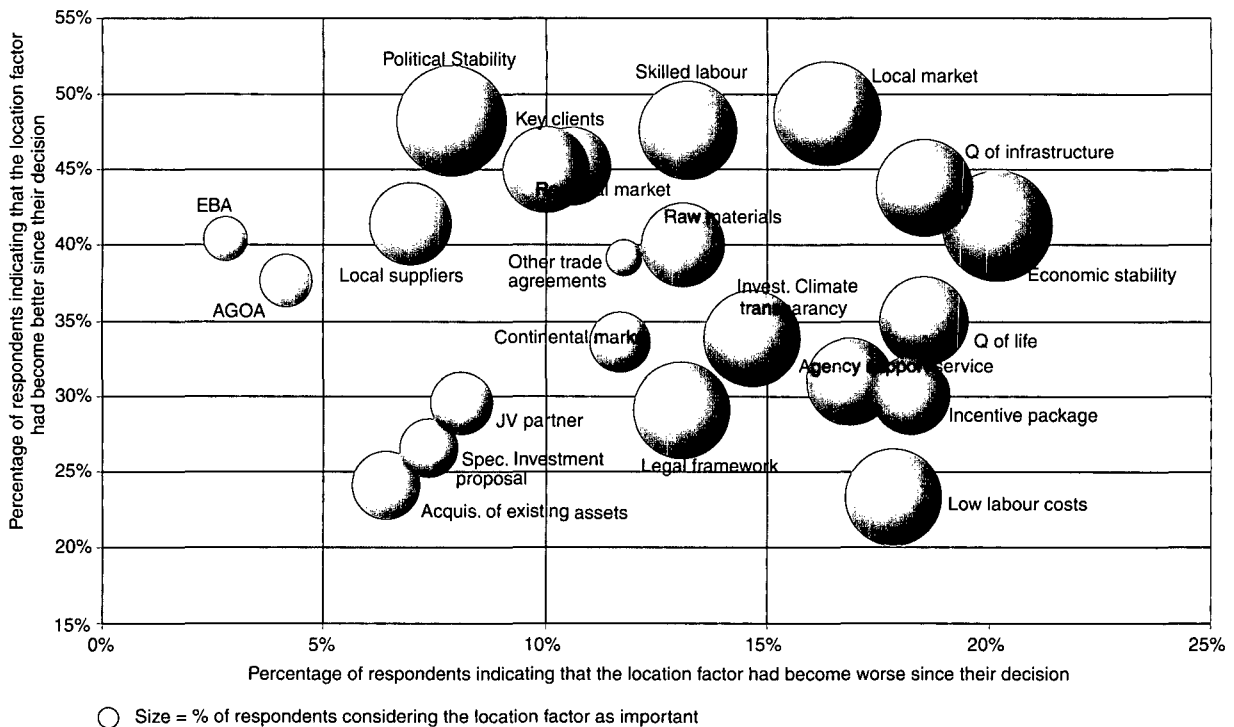

than 10% evaluated them as worse. Labour costs seemed to have evolved in a less positive way for 18% of respondents.

Important to mention are agency support services and the incentive package which had changed in a negative direction since the investor's decision according to respectively 17% and 18% of respondents. The same factors had changed in a positive direction for only 31% and 30% of the foreign investors. This could have important implications for investment promotion agencies in the individual countries.

The evolution of all other factors was somewhere in between these two extremes. Not all subgroups of investors had the same evaluation however. The country of investment obviously has an impact on the evaluation of certain location factors. In the context of this report however not all individual country differences are reported since that will be subject of detailed country reporting. However, it could be relevant to indicate which factors were subject to

country differentiations. These consisted of general business climate conditions except for agency support services, which were evaluated in the same way in all countries. Market conditions were not subject to country differences except for local market conditions and presence of key clients. Evolution of labour related factors as availability and costs were also very much country specific. From the remaining location factors only the availability of raw materials was country-specific.

Since economic stability was one of the most important factors in a respondent's location decision and since the evaluation of the change in economic stability differed widely across countries, it has been mapped in Figure 5.17.

Another important factor to mention is the labour cost conditions for the wearing apparel sector which were evaluated as getting worse by 43% of respondents. Only 14% considered labour costs as having improved in that sector. In general, large employers evaluated the labour cost factor as getting worse.

Figure 5.17. Evolution of economic stability since the respondent's decision

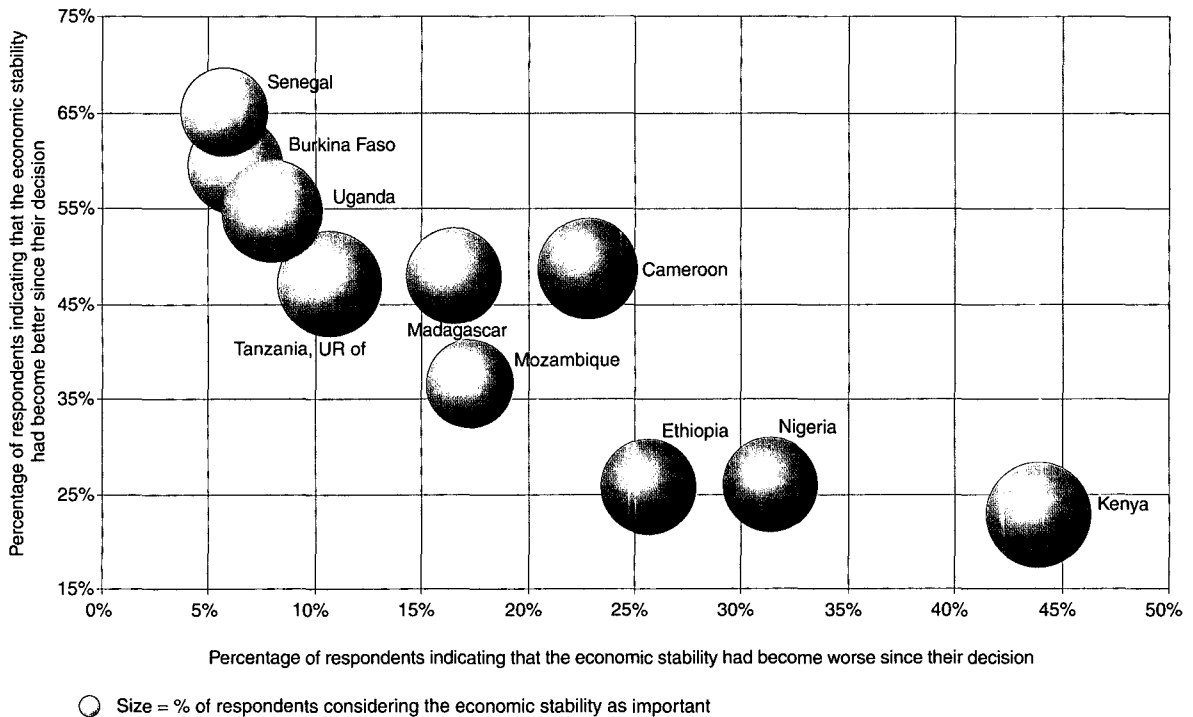

Economic impact of foreign investors

The analysis in the first part of this chapter will focus on understanding the impact respondent companies have on the region as a whole and local economies in particular. The main focus will be on understanding the economic impact of investors with particular reference to sectors, source country of investment, activities, size, entry mode, and markets served. This analysis will provide a basis for assessing the values putting resources into investment promotion efforts and yielding clues as to where to target these resources in terms of investor categories for maximum impact to the economy.

Manufacturing value added

Total manufacturing value added (MVA)⁹ per capita or the share of medium and high-tech activities in MVA is used as an indicator for assessing countries' industrial capabilities or industrial competitive performance¹⁰. For that purpose a question was included in the survey asking the foreign companies for the total MVA of goods produced to discern differences between sectors and particular subgroups of respondents.

Figure 6.1. Distribution of manufacturing goods produced in the last year (US\$)

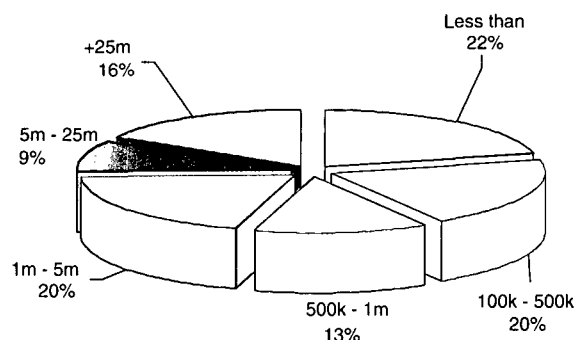

Generally speaking, MVA among manufacturing respondent companies was relatively low. Over half of the respondents involved in manufacturing indicated a MVA of less than US\$ 1 million in the last year. Nearly 75% of all respondents had a MVA of less than US\$ 5 million. This is not surprising given the findings presented earlier on technology intensity of manufacturers. In the case of our survey countries, the low added value was mainly due to the large share of the respondents in resource-based and low-technology sectors.

⁹ MVA = [Total Revenues received from sale of manufactured product(s)] – [Total Cost of “bought in” materials, components and services to produce final manufactured product(s)].

¹⁰ UNIDO, *Industrial Development Report 2002/2003* – Competing through innovation and learning.

Figure 6.2. Distribution of respondents by MVA for a key manufacturing sectors

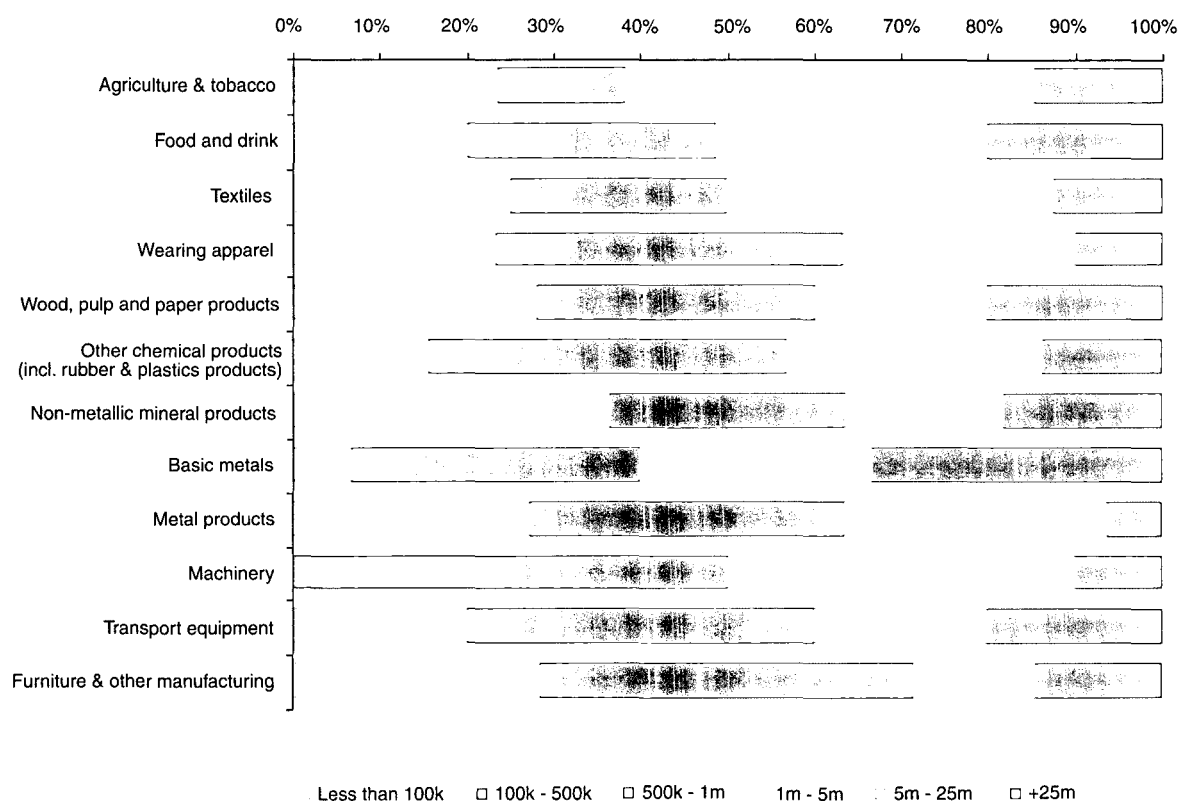

In one of its recent publications, UNCTAD¹¹ concluded that the massive increase in the volume of exports had not added significantly to developing countries' income. Although there had been a strong growth in ratio of manufactured exports to GDP in many developing countries; this had not been accompanied by a significant upward trend in the ratio of manufacturing value added to GDP. The main explanation needs to be sought in the fact that trans-national corporations typically import semi-manufactures with technology already embodied. The value added in the developing country may then be due to low skilled labour and consequently create relatively little income per capita. When the completed product is exported it is counted as a technology-intensive export, but very little technology has been employed in the country and consequently very little value added.

¹¹ UNCTAD *Trade and Development Report 2002*

Due to the relative small numbers of respondents indicating a MVA of above US\$ 5 million, no statistically significant differences between sectors could be identified in terms of relatively lower or higher MVA. The graph on MVA per sector provides some indications however, that some sectors seem to have a relatively higher MVA. Looking only at the sectors with a good representation in the survey sample it appears that particularly the agriculture, food and drink, textiles, basic metals and machinery sectors have more than half of the respondents indicating an MVA of more than US\$ 1 million.

The size of companies positively correlated with the MVA produced, the larger the company the higher MVA.

In the category of MVA of less than US\$ 1 million, 19% of the respondents were involved in medium- or high-tech manufacturing. This figure did not differ from the higher MVA group (over US\$ 5 million).

Local sourcing of inputs

A key indicator of the “local embeddedness” of foreign companies and the potential for technology transfer is often seen in the value of the inputs sourced locally.

Nearly 30% of all respondents indicated that they were sourcing less than 10% of the total value of their final product locally. Nearly two-thirds of the respondents were sourcing less than half of the value of the final product locally. Whereas about 20% of the respondents indicated they were sourcing more than 75% locally. Particularly agriculture and food and drink companies were in this category. Large export-oriented firms in the wearing apparel sector, however, are still sourcing most of their inputs elsewhere.

As would be expected, the sourcing patterns of resource-based manufactures showed that they averaged higher local sourcing. However, low- to high-tech manufacturers were typically sourcing a smaller percentage of supplies within the country.

A higher percentage of large exporters (30%) indicated they source between 75-100% of the value of the final product in the country. Obviously, local content requirements could have an impact on the sourcing behavior of those companies. This group however, shows a more extreme pattern since also 37% of respondents indicated they were sourcing less than 10% of the total value of their final product locally.

Figure 6.3. Distribution of inputs/supplies sourced

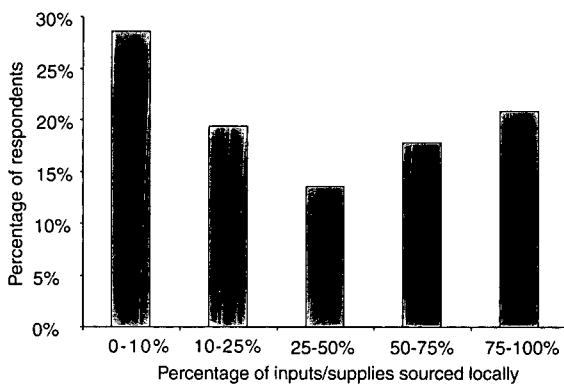

The food and drink and agricultural sector sourced a relatively higher percentage of supplies locally. The same applied for the non-metallic mineral sector. The wearing apparel sector clearly showed a more international sourcing pattern (52% of respondents sourced less than 10% of supplies locally).

Companies that invested in the region after 2000 had a significantly smaller percentage of inputs sourced locally compared to companies that had been established for a longer time. Results seem to suggest that over time companies tend to develop more local input linkages. However this issue would need more research to come to statistically valid conclusions.

Although numbers were too small to draw strong conclusions, the group of US companies tended to source more locally compared to their counterparts. Almost 60% indicated they were sourcing more than 50% of the final product value locally. Particularly Asian companies seem to rely relatively more on overseas supplies.

Local business links

The survey sought to obtain more insight in non-supplier relationships of the respondents in each country. The graph below shows the percentage of companies that had an active relationship with each of these organizations and institutions.

Figure 6.4 Percentage of respondents having a relationship with local organizations

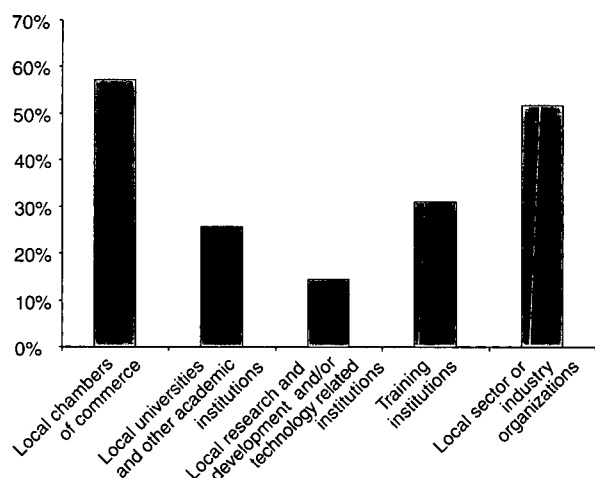

Overall, it appears that local chambers of commerce and sectors or industry organizations are the main business contacts developed between foreign investors and the local business or educational community. Despite the low local R & D intensity of the respondents, 14% indicated having an ongoing relationship with local research or technology institutes.

Remarkable differences exist among the subgroups of respondents of investor relationships with those institutions.

Relationships with local chambers of commerce:

- Were more developed in Ethiopia and Burkina Faso; less in Kenya and Madagascar
- Were more developed by food and drink, leather and leather products and metal products sectors; less by the wearing apparel sector
- Were considered less important by export-oriented companies

Relationships with local universities and other academic institutions:

- Were more developed in the United Republic of Tanzania; less in Nigeria
- Were not important at all for the wearing apparel sector
- Were less important for smaller companies
- Were more important for resource-based manufacturers

Relationships with local research and development and/or technology related institutions:

- Local R & D institutions are relatively more important for big companies and for export-oriented companies
- The agriculture sector more frequently reported relationships whereas it was not important at all for the wood, pulp and paper products sector
- In United Republic of Tanzania companies seemed to have more often a relationship with those institutions

Relationships with local training institutions:

- More important in Kenya; less in Uganda
- More important for the larger companies
- More important for medium tech companies; less for low tech companies

Relationships with local sector and industry organizations:

- More relationships in Kenya; less in Cameroon and Uganda
- More important for large companies

These results help in building a better understanding of the potential for – and nature of – linkages established by different sectors in the various countries. It provides individual IPAs with valuable input for designing their services and after-care strategy in terms of leveraging the linkage potential per sector for both existing companies and new entries in the country.

Survey implications for IPAs and other actors in FDI promotion

The pilot survey and the results of this first full scale survey covering ten countries provides valuable insight into investors' perceptions on sub-Saharan Africa as a location for FDI and on the role and impact of local governments and government bodies involved in investment promotion on shaping these perceptions. The inferences which may be drawn from the results presented in this survey will vary depending on the perspective of the different organizations involved in the industrial development process and FDI promotion. The preliminary conclusions given below will be developed further in subsequent publications focusing on specific issues highlighted by this report.

The following sections of this report set out the implications which may be drawn from the standpoint of three of the principal groups of organizations responsible for and deeply involved in encouraging FDI from both the national and international perspectives.

- Implications for national IPAs
- Implications for governments
- Implications for international development agencies

Survey implications for IPAs in the countries surveyed

The objectives of this study were largely aimed at shedding more light on the dynamics of foreign investment in general and the motivations and decision processes of foreign investors in the sub-Saharan region. Any insight into how the flow of foreign investment into this particular region can be influenced will have implications for IPAs, particularly in terms of how these IPAs could maximize their impact given their generally limited resources.

The key findings in relation to IPA strategy and organization were:

- Importance of close links with existing investors
- Importance of general business climate and policy advocacy
- Importance of getting involved in the registration or certification process
- Importance of the matchmaking function versus greenfield promotion
- Overseas strategy: important source markets for investments
- Sector strategy: focus

This survey has reconfirmed a key finding in the pilot survey that existing investors are a major source of new investments and play a major role in creating awareness of the investment opportunities in each country. In addition, existing investors with an investment performing above expectations are more likely to further expand the investment and more often expect to create additional jobs in the country.

Developing closer relationships with the existing investors in the country requires an organizational structure designed to achieve this in an effective and efficient manner. One very positive feature of the survey was that it showed the vast majority of existing investors actively welcomed better and closer contact with their IPAs. Promotion agencies are strongly urged by their existing client base for an open door policy when it comes to developing contacts. To achieve this, IPAs must facilitate the implementation of an appropriate client relationship management programme through appropriate organizational modifications, capacity building of staff and, if required, recruitment of new staff with the appropriate skill profile. This involves team building with IPAs and increasing focus on developing relations with existing investors rather than pursuing new investors without a base upon which to build a focused promotion strategy. Developing good relationships with existing clients requires that the relevant staff in the IPA receive the training necessary to carry out this function. This is an activity that should be prioritised within all the IPAs surveyed. It also follows that separate teams should be formed to work specifically with potential incoming investors, inward missions and group visits to foreign markets.

Contrary to the situation in the more developed economies of Europe, for example, foreign investors in sub-Saharan Africa attribute higher importance to general business climate conditions when selecting a location than to labour market factors. There is a huge opportunity for countries to increase FDI performance by making strong and sustained progress in enhancing the general business climate conditions. The survey showed that overall business climate factors such as political and economic stability, transparency and legal framework have improved in the region as a whole. However, there is still room for improvement in this area and the countries most successful in "getting the basics right" will be the most attractive to these foreign investors. Policy advocacy is therefore of crucial importance and needs to be a key function of each IPA. The findings of this survey, in combination with the close contacts to be developed with existing foreign investors, should provide IPAs with sufficient input for setting priorities in business climate improvement and

developing the needed arguments to influence policy.

The survey indicated that when IPAs get involved with investors at an early stage, there is more scope for providing a broader range of services and consequently a tendency to have a larger proportion of "content" investors. Nearly all the investors that were made aware of the investment opportunity in the country by the IPA and/or investors that got in touch with the IPA during registration and certification found this initial contact very useful in facilitating other IPA services, incentives and other benefits. There is great interest among investors in using IPA services, however many of them were not aware of the existence of an IPA and its service offerings. IPAs should create a mechanism to establish contact with potential investors as early as possible by being somehow linked to all processes involving foreign companies. This implies close networking with other government departments and national institutions that contribute to different aspects of investment promotion and administration. Increased recognition and visibility among new foreign investors entering the country and greater interaction with them is an essential first step for IPAs in influencing FDI in their respective countries.

An area of particular attention should be to improve the reception that investors receive when they interact with IPAs or other sections of the Public Administration for registration or certification. If efficient service is not provided, the reputation of the IPA, the administration and the country suffers alike in the minds of the FDI community.

Although the concept of the IPA as a one-stop-shop to deal with administrative barriers and provide a more streamlined and investor-friendly policy environment has been fashionable for some time now, no research or evidence has been found that this is indeed the magic solution for sub-Saharan Africa. Although the concept might be appealing in theory, implementing it effectively is far from easy. Experiences of the one-stop-shop concept are varied and are not particularly positive in many instances¹². Lowest cost solutions providing fast

¹² "Do One Stop Shops Work?" Paper written by Frank Sader, Foreign Investment Advisory Service (FIAS), The World Bank Group, 2002.

results should embody the one-stop-contact concept, whereby the IPA develops close and effective working relationships with all the government administrative entities involved in the investment approval and implementation process, rather than trying to internalise these functions. Bottlenecks in the administrative procedures should be identified and reform advocated and urged by the IPA. Very often installing basic information technology can be a key enabler in streamlining some of these processes.

The results of this survey show that although joint ventures are not unimportant, greenfield is the mode of entry to the region for the majority of existing foreign investors. This may be a result of insufficient/ineffective promotion of joint venture partners in the past. However, the growing numbers of export-oriented investors in the region seem less interested in the joint venture and M&A options. In terms of strategy and organization, this implies that sufficient resources should be made available for targeting and servicing greenfield investors.

Survey results show that United States and Japanese companies, which are typically among the leading investors across the world, are largely absent in the survey region. Should the IPA have the means available to establish overseas offices or an overseas representation network at embassies for example, the survey findings on key source markets for foreign investment should be taken into consideration.

In terms of prioritizing future investment promotion programmes, the first priority for IPAs should be to work with the existing investor base. The survey revealed that nearly 70% of the existing foreign investors were planning either an expansion investment or the establishment of a new facility. This finding combined with the fact that 51% of the investors with expansion plans would also strongly consider other locations besides their current location implies that a huge market potential lies right at the doorstep of each IPA. As already indicated, the existing investors do welcome IPA support services, but appropriate staff skills and client relationship management programmes are required. These hardly exist in most African IPAs at present. Contact with investors tends to be either non-existent or focused on a few high profile clients, while the

majority is simply ignored or monitored for compliance with incentive conditions, at best.

Since private-sector networks and existing investors play the most important role in new investors' decisions, IPAs should make satisfied existing investors a centrepiece of any promotion strategy. By facilitating consultative platforms between groups of investors and government policy makers and being seen as partners in lobbying for policy reform would make it easier for IPAs to recruit representatives of the investor community as "ambassadors" and lobbyists in international promotion efforts. Success stories and testimonials of satisfied investors would make the most convincing promotional material.

Generating Re-investment

The survey gave detailed information on the future investment intentions of existing investors. From this it was possible to identify between US\$ 1.6 to 3.1 billion in planned future investment and to pinpoint those who were to be the lead investors over the next three years. This key information obtained through the survey will enable the IPAs to focus their short-term promotion efforts on those most likely to yield the most immediate results. IPAs need to demonstrate their relevance and effectiveness in generating investments to gain the respect (and constructive cooperation) of the very institutions with which they need to network. They also need to demonstrate this to the bodies that will allocate funds for their budgets, since the effectiveness of the IPA does depend on the resources they have at their disposal for designing and executing programmes.

The survey also allows IPAs to identify sectors and subsectors that are most likely to expand or contract in the next few years. In terms of a sector promotion strategy abroad, the survey results suggest that a very small number of sectors make up the majority of foreign investment in the survey countries and only a smaller selection of these sectors show mobility (e.g. food and drink and textiles and wearing apparel). Obviously, the IPA should be responsive to every single investor that shows an interest in the country. However, when it comes to pro-actively targeting specific sectors through in- or outward investment missions, for example, the right mix of source

markets, sectors and activities (export versus local market) should be targeted to ensure the most optimal and effective use of the available resources. Subsequent analysis of the respondents could shed more light into the structuring sector specific strategies for IPAs in different countries.

Investment services and facilitation

The survey strongly indicated that investors' primary relationship with IPAs consisted of the certification of their projects. Nearly 50% of the respondents were registered by an IPA. This process was highly valued by over 90% of the investors and 90% of them found this registration process useful to some extent in obtaining taxation and other benefits. This is not that surprising given that in most countries investors have to get the certificate to qualify for tax and other incentives. What needs to be determined is whether the certification process can be made a vehicle to strengthen investor – IPA ties and enable the development and delivery of other support services.

Only 57% of the respondents greatly benefited from the services provided by the local IPA by seeking further assistance in a number of specific areas such as basic information on the business conditions and specific taxation areas. It would appear, therefore, that there is scope for the IPAs to further improve the range of services offered in the form of extending assistance to the 43% that did not receive any assistance, and improving the services in areas where assistance was sought but received an inadequate response. The pre-investment services most requested by more than 75% of the foreign investors included:

- Information on taxation and incentives
- Information on doing business in the country (includes information on required permits and procedures, labour regulations, etc.)
- Information on investment climate conditions (includes political and economic stability, legal framework, etc.)
- Information on costs of doing business in the country (including labour costs, property costs, utility costs, etc.)

- Information on import/export regulations and tariffs

Services under these headings could probably be easily extended and standardized, since they mainly relate to information provision. Having the information requested by more than three-quarters of the investors readily available would lead to a quick response time to investors' inquiries. It would also free up the IPA staff for other non-standardized pre-investment services, such as introductions to local suppliers, potential joint venture partners and organizing fact finding trips, for example. The better use of information technology for storing, continuously updating, packaging and distributing investment climate information to a wider audience is crucial.

Providing good quality pre-investment services to investors will encourage companies to seek IPA support in subsequent stages of their investigations and again once the final decision has been made. It is important to secure a potential investor's trust at an early stage.

Standardizing as many information services as possible would also free capacity for actual investment facilitation in the country. Services that were requested by more than 75% of the foreign investors to facilitate their investment implementation once the location decision had been made included:

- Company registration and licensing
- Obtaining permits
- Incentive applications

Between 55-65% of the investors using these services were happy with the service provided by the IPAs. Although this is a relatively high number and an encouraging result, it still means that between 35-45% of the investors were not satisfied with the quality of the services provided. IPAs should have dedicated and well trained staff that guide and actively support companies going through these important application procedures.

Although the three services listed above were considered most important, the survey results in chapter three show a whole list of other implementation services that are perhaps slightly less important but still considered important by 40-60% of the foreign investors. It is particularly this second group of

important implementation services that needs attention, as only a small percentage of the investors indicated that these services were provided well.

Based on this important finding in the survey, the service capacity needs of individual countries will need to be analysed in more detail and subsequently translated into country- and IPA-specific capacity building programs. These are the services that can help investors' fast-track implementation of their investment and ultimately contribute to the satisfaction level of the investor with the country location in general and the IPA in particular.

Post-investment services and after-care

Investors relied on the services of the local IPA for registration services, which subsequently appeared to be an important step in also obtaining incentives and other IPA services.

Those services most valued tended to concentrate on administrative rather than commercial concerns. There are indications that executives within IPAs need to become more familiar with investor needs, which relate to private commercial networks, especially in the financial services areas.

This survey points to the need for IPAs to make strenuous efforts to develop close relationships with the existing investors and other private-sector networks. This would include suppliers, chambers of commerce, and other organizations within the business sector such as banks, consultants, accountants and other service providers to the business community. As was clearly demonstrated in the survey, these organizations play a pivotal role in influencing investor decisions.

This survey revealed an interesting distinction between the way investors regarded individual executives within IPAs and the organizations themselves. About 95% of the investors that received services from the IPA before and after the investment decision found the level of expertise of IPA staff either good, very good or excellent. The performance of the IPA as a whole in the last few years was ranked below or well below expectations by one-fourth of these investors. This gap between the perception of the executives and the agency itself may indicate that

with some more resources the agencies would be able to provide more services. The image of the agency as a helping hand rather an administrative clearinghouse must be developed and nurtured and the survey seems to indicate that this may be easier than expected.

Survey results show that the most important services that could help investors expand in the country once they are established mainly include incentive related support, such as obtaining duty exemptions and other fiscal incentives, as well as accurate information on specific industry or business climate questions. By studying for each country the specific requirements of investors who indicated what it would take for them to substantially increase their investments, the IPA could not only generate new investments from them but also determine where it has to improve service delivery and facilitation to influence investment decisions of broad categories of investors.

Survey implications for national governments

In general terms, the implications that can be drawn by national policy makers are positive. The majority of the investors report a reasonable level of satisfaction with the performance of their investment and a majority is planning on further investments, some quite substantial.

The review of the location factors that influence the investors' decision regarding the location of investment reveals the high importance of an attractive and stable investment climate. Governments that take improvement of the political, economic and legal aspects of the investment climate most seriously will be among the most attractive locations for foreign investors. The survey results confirm the importance of efforts that have been made until now in most countries, and should be strong encouragement to continue enhancing the basic country investment conditions. Investors are rational actors that normally trade-off the risks associated with investing in a particular country against potential rewards when comparing between different location options. Countries in sub-Saharan Africa that are able to offer the most attractive combination of low

risk and high rewards will be among the regional winners in terms of attracting FDI in the next few years. It seems that in the case of Madagascar, political instability during the first half of 2002 had a clear negative impact on the investment performance of foreign companies and consequently future investment intentions of these companies in the country.

The review of motivation indicates that local market conditions and international trade agreements will largely determine future FDI growth. If experience elsewhere is a guide, the development of the different trade blocks that are taking shape in Africa could mean an extra stimulus to new investors seizing the opportunity of serving wider regional markets rather than just local markets. A substantial part of the companies in the survey were already indicating that regional economic integration and trade agreements are important. The survey revealed that export-oriented industries serving continental markets are strongly emerging and this motivation group has become more prevalent among recent investors. Particularly apparel companies taking advantage of African Growth and Opportunity Act (AGOA) have contributed to this trend. Kenya and Madagascar are among the best examples in this survey of countries that greatly benefit from AGOA in terms of increased inflow of export-oriented FDI. This finding should urge other AGOA-eligible countries and their governments to seize these opportunities offered by new trade agreements.

The study found that particularly Asian investors have become an important source for new investments in the region, particularly also in export intensive industries such as wearing apparel. At the same time it appears that these investors have the least impact on the local economy in terms of developing local supply linkages. However, a Special Rule for LDCs, which currently allows these countries duty-free access to the United States market for apparel made from fabric originating anywhere in the world ends 30 September 2004. This will offer new opportunities to host country governments in terms of helping these existing Asian investors finding local supply sources.

The survey noted that the investment environment was seen as a restricting factor for future expansion

by a significant proportion of investors. A major reason why investors failed to reach expectations were the constraints presented by general business climate issues, including political and economic instability and government bureaucracy. To a certain extent this information is not new to the governments in each of the countries surveyed. However, it is yet another example of the investment environment being made less attractive by the actions of government departments, and therefore responsibility lies with the government itself. Other factors mentioned as contributing to the failure to meet expectations are mainly market forces, which are largely beyond government control. Global competition, rising operating costs and the global economic downturn were among the reasons mentioned.

However, it is clear that there is much work to be done. Three key areas of policy attention came forward from the survey results:

- In most countries included in the survey, foreign investors felt that although basic investment conditions such as political stability, economic conditions, transparency, rule of law, bureaucracy, etc., have improved, there is still much room for further development. Governments should therefore remain focused on enhancing general investment climate conditions and minimizing government failures that inhibit the inflow of FDI.
- Regional and global trade agreements are considered important to existing investors and are offering good opportunities for attracting more FDI into the region. The AGOA trade agreement particularly attracts an increasing number of export-oriented investors keen on serving the US market, creating thousands of new jobs in some of the survey countries.
- In addition to market conditions, current incentive schemes provided to the investor (such as tax reductions and duty exemptions) play an important role in future investment plans of existing investors. Particularly for the fast growing contingent of export intensive investors these factors are very important. Governments should be

aware of the importance of this factor and need a balanced win-win tax and incentive policy that is favourable to new investors, but at the same time generates income for the host country.

- In several survey countries the national IPA was underperforming according to the majority of the investors and it became clear that various other countries need to further enhance the performance of the IPA. There is a clear responsibility for governments to ensure that national IPAs are receiving sufficient resources to be able to deliver at least the most important services requested by investors. Without this minimum amount of resources, agencies are handcuffed and cannot seize the existing market opportunities and deliver according to foreign investors' demands and expectations.

From the point of view of national governments, an obvious benefit to conducting the UNIDO survey on a regular basis is that it enables them to benchmark performance and introduce programmes to implement effective low-cost investment promotion strategies. Furthermore, the data obtained on the future investment plans of the firms provides a forward looking indicator for government policy makers and economic agents. In most developing countries, such data is completely lacking due to defects within the National Statistical Services and lack of resources among the Investment Promotion Agencies (or their recognition among the existing foreign investor base) to successfully conduct such large-scale research.

The UNIDO survey conducted on a bi-annual basis would provide information on future trends and serve as another benchmark for governments, especially since they will be able to compare expectations with those of other African countries. Several indices have been prepared based on the survey results that help governments benchmark their position against other countries in the region and monitor performance over time.

Implications for development agencies

Information on such issues as future investment plans and the IPA support services required by these investors on a country-by-country basis would undoubtedly help in planning and designing future assistance programmes. A better understanding and more detailed knowledge of what the actual mechanics of the investment process are, and how it is changing, is essential if programme planning and design is to be developed in a meaningful manner. Designing assistance programmes is frequently based on anecdotal evidence and the superimposing of best practices established by successful agencies. There is little opportunity to evaluate the positive and negative developments over time and continuously adjust the nature of the assistance to changing conditions and immediate needs. The survey is intended to provide such inputs from a private-sector perspective and add new dimensions to other surveys being conducted*.

Over the years, a great deal of technical assistance has been provided to developing countries in Africa. Much of this assistance is to spark and sustain growth by facilitating private initiative. The results of the survey and subsequent analyses that will be carried out can provide the opportunity to conceive interventions that can potentially deliver the most impact per donor dollar in this respect. It allows the design of very concrete actions with clear expectations of results.

Given the growing number of export-oriented investments in the survey region, mainly resulting from new trade agreements, there is an increasing opportunity for focusing industrial development support to sub-Saharan countries. Export-oriented foreign investments are seen as a potential engine for countries to move up the industrial development and manufacturing sophistication chain. Leveraging this potential and maximizing the benefits of these investments to the host country should immediately become key objectives of governments in these countries and the map for future technical assistance.

Indices to watch

The survey data will allow country rankings on many key FDI attractiveness indicators for the sub-Saharan region and on a variety of important investment promotion related issues. These indicators will be developed in more detail as the data is analysed in more depth and updated every two years, allowing individual countries and IPAs to monitor progress in their FDI attractiveness performance and also monitor their position and progress relative to other countries and competitors in the region. The first part analyses the individual country performance on the key location assessment criteria for foreign investors. In a second part, sector mobility indexes were developed.

Country FDI environment performance indicators

Business climate conditions

In the top eight most important factors in investor location decision making for the foreign investor sample as a whole, 5 factors were general business climate conditions, including: *political stability, economic stability, quality of infrastructure, legal framework and investment climate transparency*.

The survey showed that particularly political stability and economic stability were considered most important by foreign investors. Since these factors are considered most important by many foreign investors, they largely determine a country's attractiveness for foreign investment. Countries should therefore make every effort in enhancing the country conditions on each of these five factors.

The Graph 8.1 shows the weighted percentage, per country, of foreign investors' perceptions regarding developments in the country business climate since their establishment. It is important to note that the ranking does not reflect the status of the investment climate in each country but rather the progress made in enhancing the quality of the investment climate as perceived by the foreign investor community.

The large share of companies in Kenya that feel the investment climate has deteriorated are mainly concerned with economic stability and quality of infrastructure having become worse. Especially the investors established before 1995 think the economic stability had become worse. For Nigeria, economic instability and poor infrastructure are the main contributors to the 26% indicating the investment climate has deteriorated.

Overall, good progress is being made in almost all countries in the survey. In most countries, more than one-third of the foreign investors that responded to this question felt the general business climate was improving. Senegal, Burkina Faso and Uganda

showed to be leaders in enhancing business climate conditions in the country according to foreign investors in these countries.

Market conditions

Other key factors in location decision making were the local market and the country labour market conditions. The Figure 8.2 below provides a ranking based on investor perceptions on the progress being made in improving local market conditions.

Overall local market conditions were perceived to have been improving in nearly all countries, although particularly in Eastern and Southern African countries a considerable share of the foreign investors also indicated that local market conditions were getting worse since their investment decision. Burkina Faso and Uganda showed to be leading in this respect. Kenya was the only country where relatively more investors indicated that market conditions had become worse rather than better.

Figure 8.1. Foreign Investor Perceptions Investment Climate Improvement Monitor

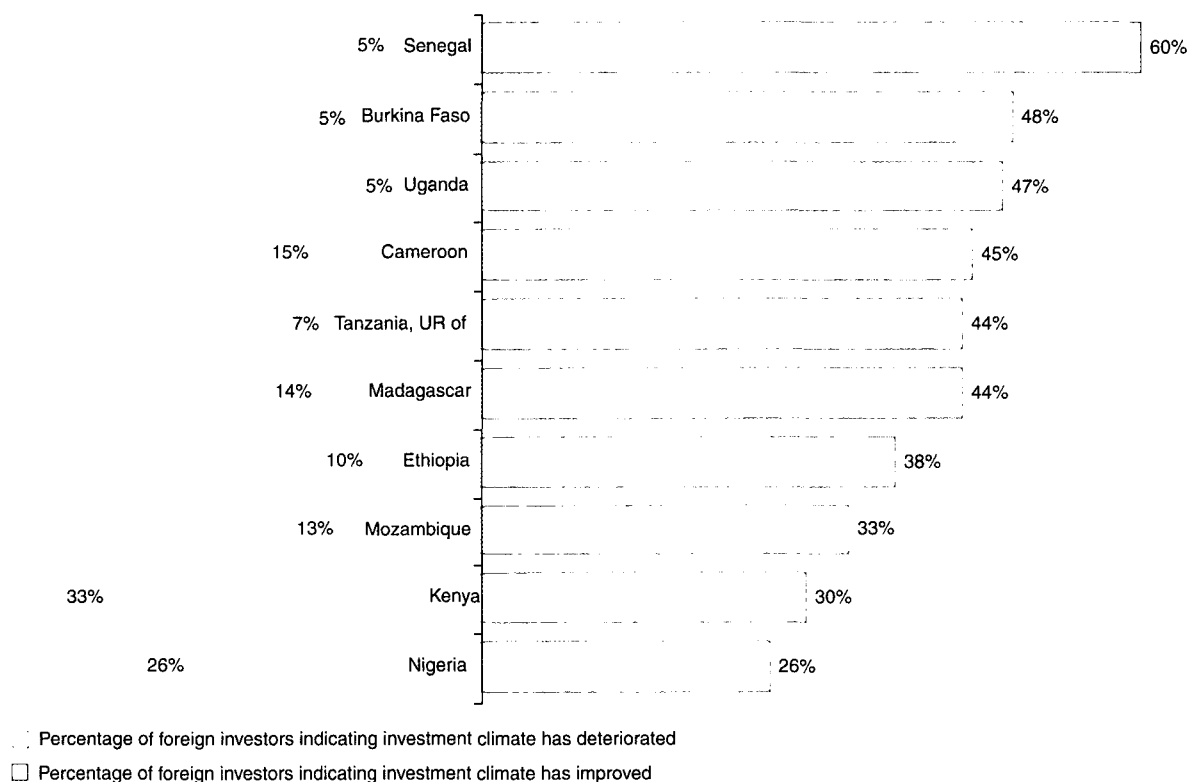
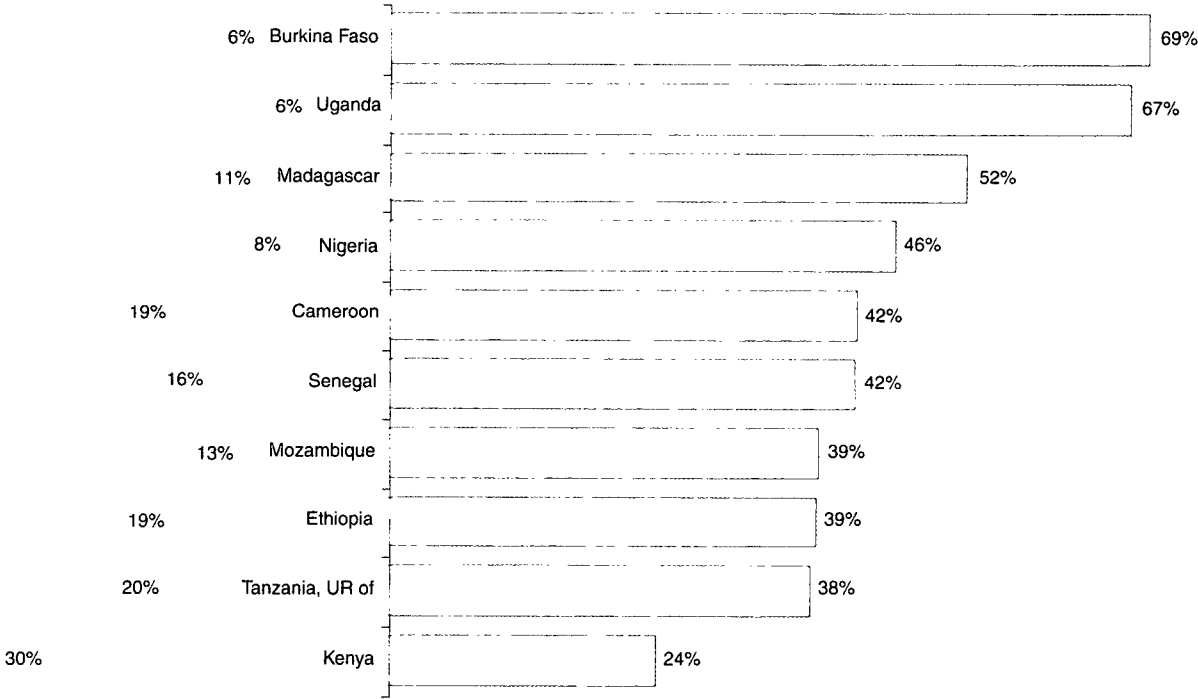

Figure 8.2. Foreign Investor Perceptions *Local Market Conditions Monitor*



Percentage of foreign investors that felt local market situation has deteriorated
Percentage of foreign investors that felt local market situation has improved

Figure 8.3. Foreign Investor Perceptions Performance of the investment over the last three years

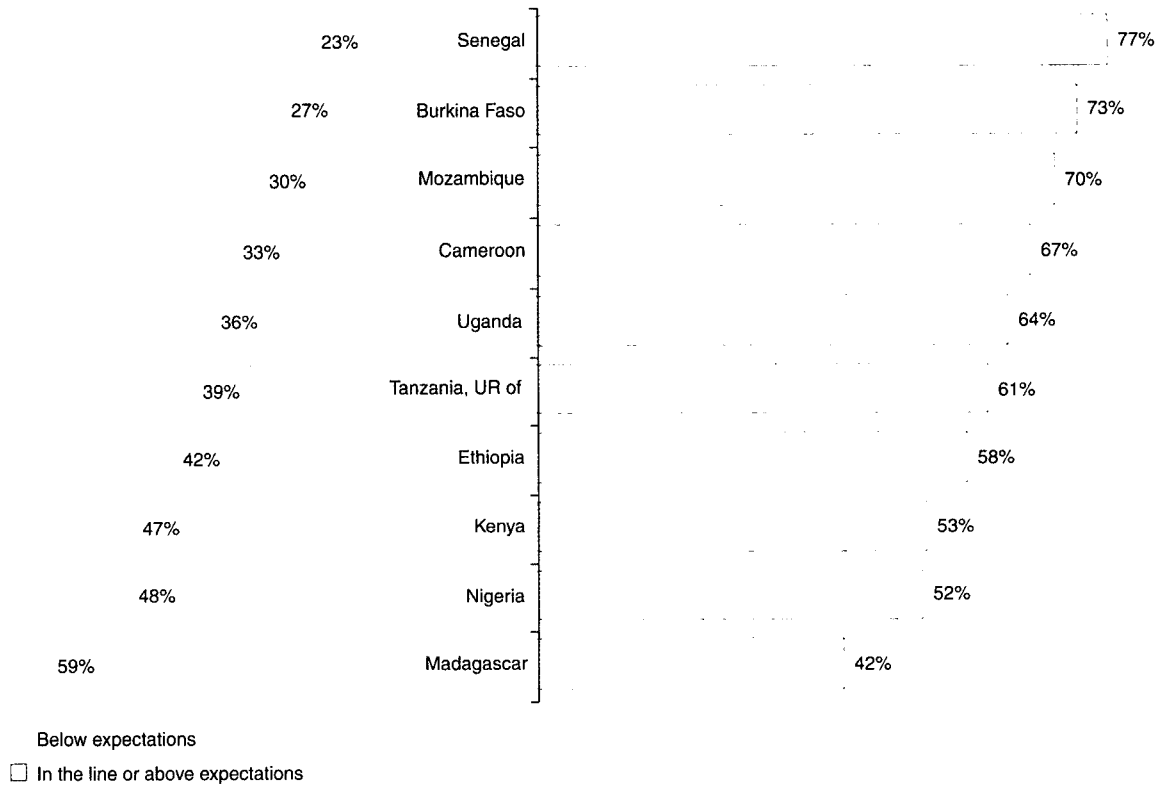
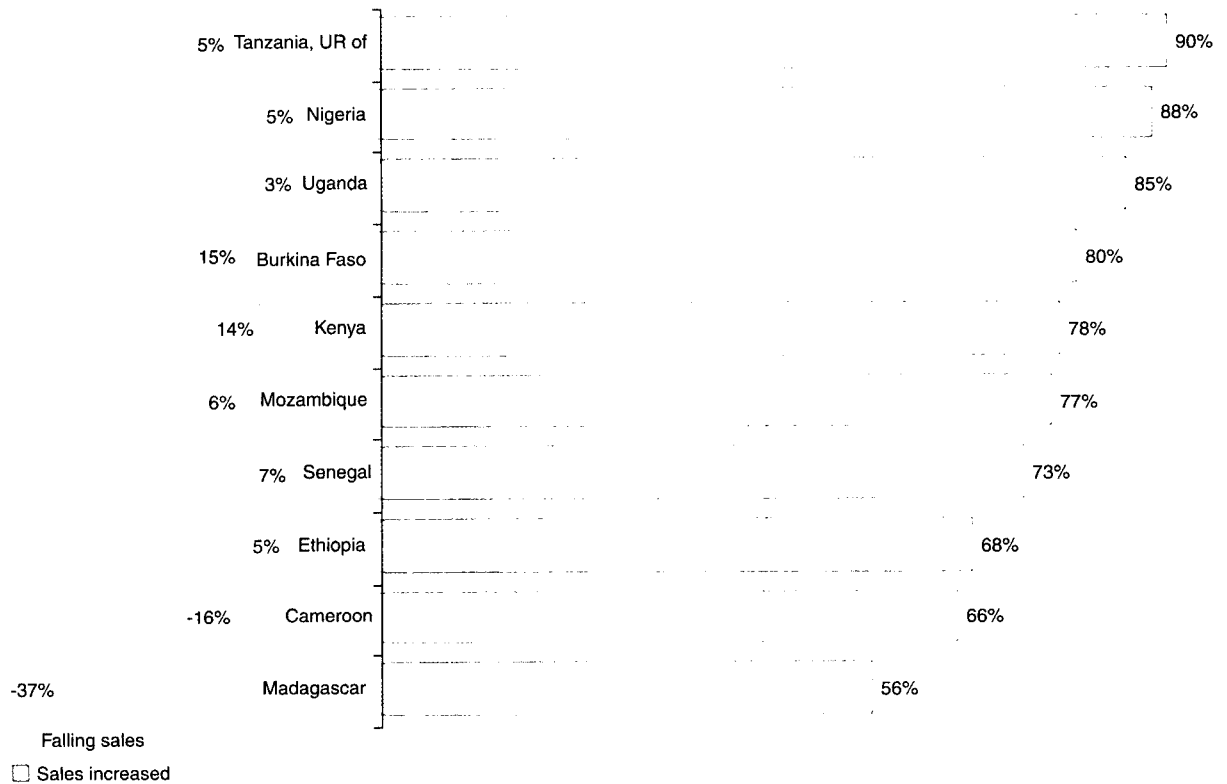

Figure 8.4. Foreign Investor Perceptions Sales growth last year



Performance of the investment

It is important for local IPAs to know how existing investors evaluate the performance of their investment in the country in the last three years. As seen earlier in this study, existing investors play a very important role as ambassadors and are able to positively or negatively influence investment decisions of other potential investors.

Overall, last year's sales growth figures look good for most countries, except Madagascar.

Export intensive companies especially in the food and drink sector and some wearing apparel companies, were reporting falling sales due to the political crisis during 2002 and unstable operating conditions.

Performance of the local IPA

Based on the ranking below it can be concluded that IPAs in Kenya and Madagascar should pay strong attention to enhancing client satisfaction.

The graphs on evaluation of investment performance and evaluation of IPA performance seem to indicate some similarities. However, as indicated earlier in the report, IPA performance was never mentioned as a main reason for poor investment performance.

Figure 8.5. Foreign Investor Perceptions IPA performance last three years

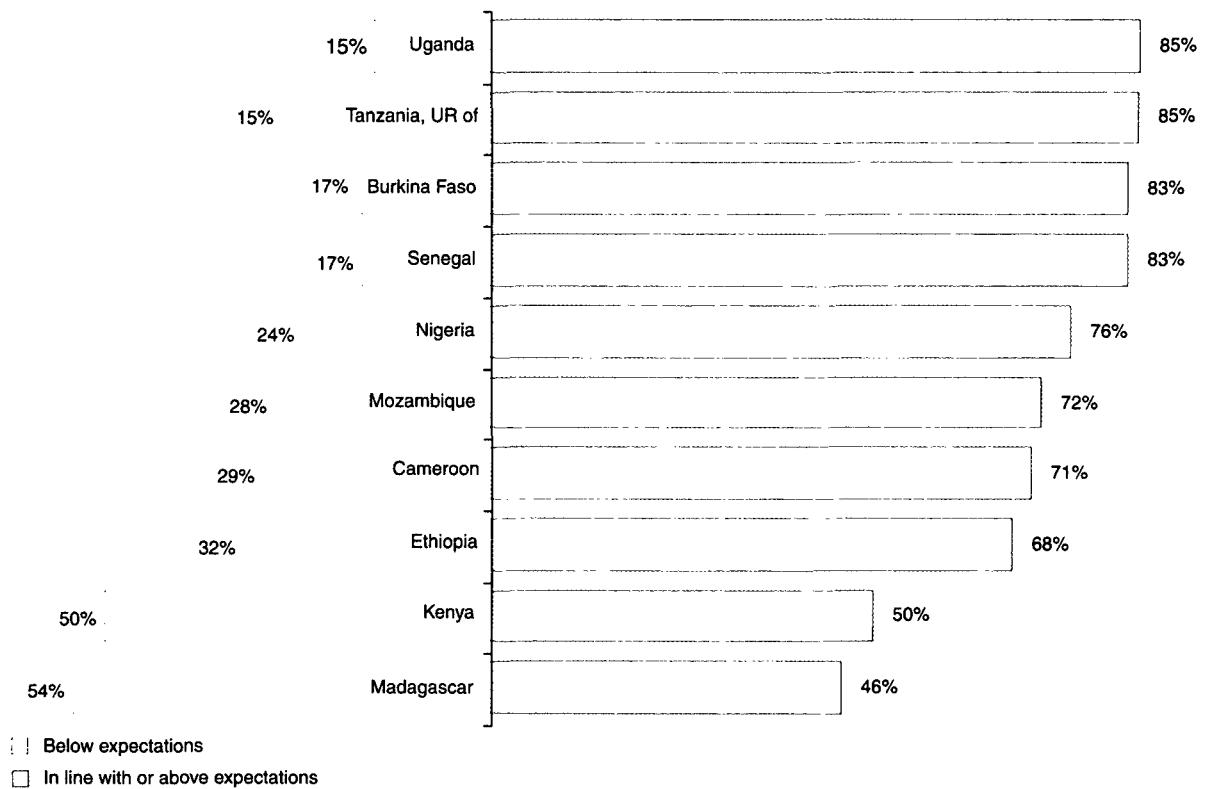

Local resources

The last important category of location decision factors consists of labour market conditions. Both labour availability and labour costs play a very important role in the location decision making of foreign investors.

Overall the availability of skilled labour had improved in all countries. In Senegal and Burkina Faso no investor thought the availability of skilled labour had become worse. Only in the United Republic of Tanzania and Mozambique did a considerable share of the investors thought this was the case.

Sector Mobility Index

The two Figures 8.7 and 8.8 show recent and future investment mobility in sub-Saharan Africa. Figure 8.7 shows the share of investors within the total group of investors in that particular sector that entered the region in the last few years (after 2000).

The Figure clearly shows the increasing interest of textiles and wearing apparel companies in setting up operations in the survey region and as widely known sub-Saharan Africa as a whole. African Growth and Opportunity Act (AGOA) is the major explanatory variable responsible for this trend.

Figure 8.8 shows the top 10 sectors announcing further expansion in the region over the next three years. Percentages reflect the percent of foreign investors in that category planning further expansion in the next three years.

Further expansion includes the expansion of existing operations or new facilities within or outside the country of current operation.

Figure 8.6. Foreign Investor Perceptions Skilled Labour Availability Monitor

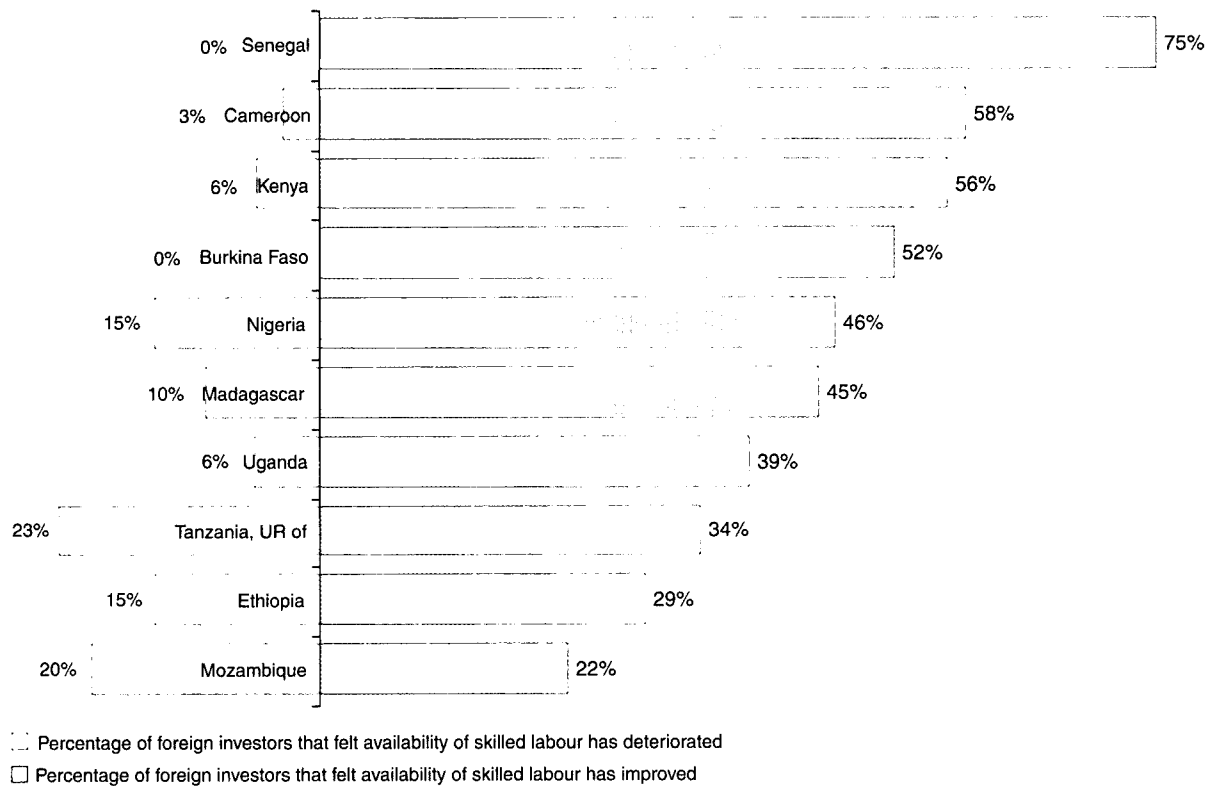

Figure 8.7. Top 10 mobile sectors for inward FDI in sub-Saharan Africa (in the last three years)

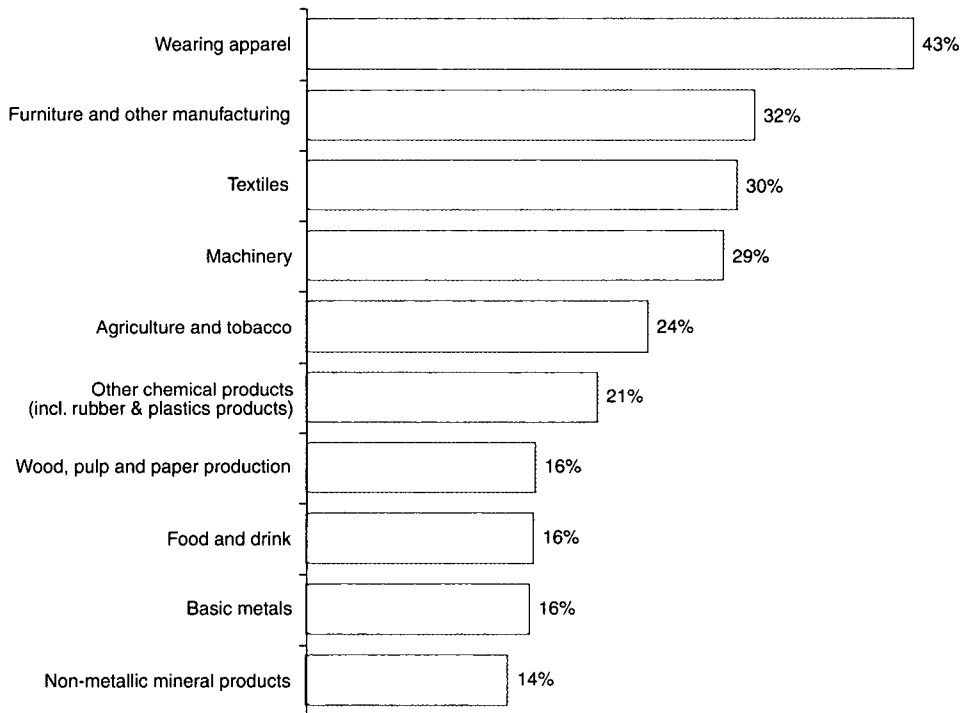
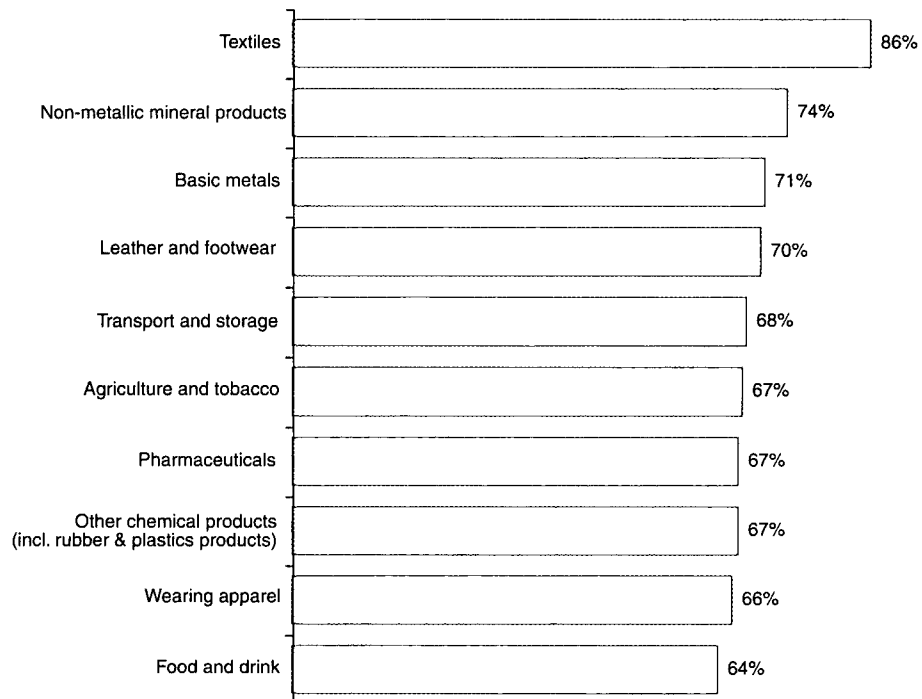

Figure 8.8 Top 10 sectors planning expansion investments in sub-Saharan Africa (in the next three years)



FOREIGN DIRECT INVESTOR PERCEPTIONS IN SUB-SAHARAN AFRICA

Overall the list of companies planning expansion investments (of more than US\$ 100K) was very extensive also in other sectors.

Interestingly, the results clearly show that the lead-

ing sectors in terms of recent inward investment are also found in the top 10 sectors planning further expansion in the next three years, thus increasing their commitment to the region even further.

The impact of international trade agreements on FDI in sub-Saharan Africa: the case of AGOA and EBA

This section highlights evidence found in the survey of the economic impact of two important trade agreements (EBA and AGOA) on the 10 sub-Saharan countries surveyed. Since this survey focuses on FDI in sub-Saharan Africa it will only highlight findings related to FDI inflows and related exports that can be directly attributed to the existence of these trade agreements.

The impact analysis will be followed by an illustration showing an individual investor's experience in terms of motivation for investment in the region, the role of trade agreements, important factors in location selection and the type of IPA services requested. The case has been selected based on the crucial importance allocated by the investor to AGOA in its decision to establish in the survey region.

Introduction

Two of the most recent initiatives affecting sub-Saharan Africa are the EU's "Everything But Arms" (EBA) initiative (started in 2001) and the African Growth and Opportunity Act (AGOA) of the United States (started in 2000). Trade preferences schemes are a key element in industrialized countries' efforts to enhance the integration of particularly the least developed countries (LDCs) into the world economy. Preferential trade tariffs for exporting to North American and European markets are expected to encourage the import of products from these LDCs, raising the export earnings of these countries and stimulating (foreign) investment and economic growth.

In short, the European Union's (EU) EBA initiative grants duty-free access to imports of all products from the least developed countries, with the exception of arms and munitions, and without any quantitative restrictions. Liberalisation was immediate except for three products - fresh bananas, rice and sugar - for which tariffs will gradually be reduced to zero (in 2006 for bananas and 2009 for rice and sugar). There are duty-free tariff quotas for rice and sugar, which will be increased annually. The majority of products already received duty free treatment under the Generalized System of Preferences (GSP) or Cotonou Agreement. The EBA proposal, however, extended tariff and quota free access to the EU market to a remaining group of 919 products. The vast majority of these products are agricultural products, including certain meat products, vegetables, fruits, wines and prepared foodstuffs, such as biscuits and jams.

AGOA offers sub-Saharan African nations duty-free access to the United States market for thousands of products. AGOA provides duty-free treatment for an additional 1,835 goods not covered under the GSP programme (covering 4,650 products) for sub-Saharan African beneficiary countries until September 2008. Thirty-eight of the 48 sub-Saharan African countries are now eligible for AGOA. The first imports under AGOA entered the United States in 2001. Prime sectors taking advantage of AGOA include textile and wearing apparel and agri-business. Particular

areas where AGOA is proving to have the most effect on sub-Saharan countries are the inflow of foreign exchange and the revival of the textile and wearing apparel industries in many of these countries. sub-Saharan Africa is facing stiff competition from India, Bangladesh, Egypt and China in exporting textiles and wearing apparel to the United States.

Survey results

Among the nearly 758 foreign companies surveyed in 10 countries, there were 27 companies that considered taking advantage of AGOA as crucial factor in their investment decision, whereas 16 investors considered taking advantage of EBA to have been a crucial driver in their investment decision. In the

period after 2000, these companies represented 11% of all new investments and 26% of all new export-oriented investments among the survey population.

The surveyed companies taking advantage of AGOA are employing approximately 50,000 staff and have a total investment value of US\$1.3 billion, compared to the 40,000 staff and US\$ 1 billion investment value of companies taking advantage of EBA. These figures are almost negligible when looking at the total FDI stock (value) and employment in these countries.

An encouraging sign is that many companies set up after AGOA came into force. These findings seem to suggest that AGOA is indeed generating increased export-oriented FDI inflows into the survey region. In particular, Madagascar, Kenya, Mozambique and

Figure 9.1 Importance of Trade Agreement in investment decision of foreign investors (number of respondents considering the trade agreement important or crucial)

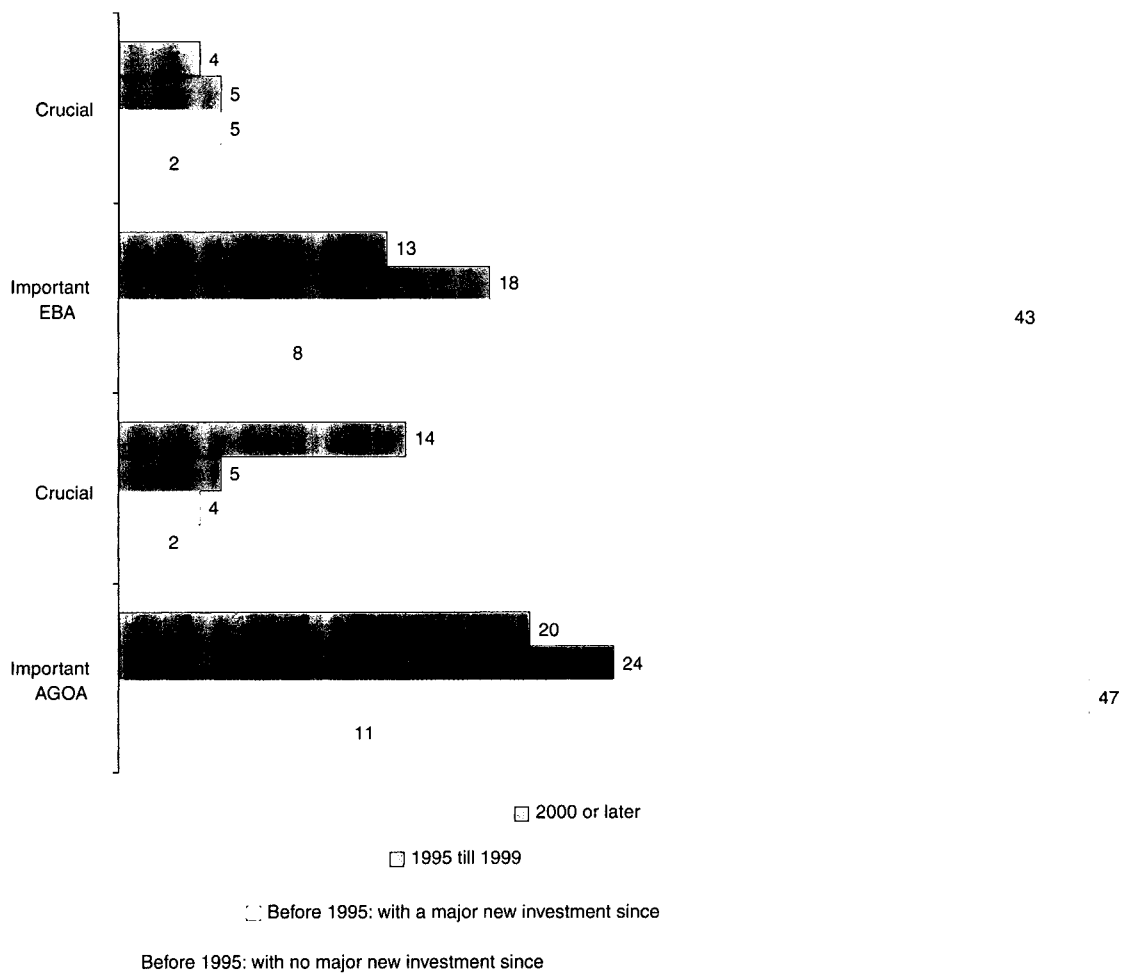

Uganda are receiving new investments as a result of this. More studies need to be conducted to ascertain whether these trends will continue under changing conditions.

The EBA agreement seems to have less influence on foreign investment trends in sub-Saharan countries. One explanation could be the fact that the EBA agreement brought little change to the trade and exports statistics of LDCs¹³. Over 99% of EU imports from the LDCs are products that the EU had already liberalised, and the complete removal of barriers to the key remaining products, rice, sugar and bananas, has been delayed since. Although the EBA agreement seems less important in terms of generating more FDI in sub-Saharan Africa, it is considered either important or crucial by nearly 20% of the foreign investor population in the survey region.

Besides attracting new investments to the region, both agreements are also considered important for nearly one-third of existing foreign investors in the region. A very large group of investors already established in the region before 1995 (but that have made a major investment since) indicated that either AGOA or EBA was important to their investment in the region.

Origin

The origin of these investors is largely Asian, African and European countries. AGOA, in particular, seems to attract new investment to the region from Asia. American investors do not figure among the foreign investors taking advantage of either AGOA or EBA.

Sector orientation

The majority of the companies that found AGOA crucial in their investment decision were in the wearing apparel (52%) and textiles (15%) sector, followed by food and drink (11%) companies.

The sector orientation of companies taking advantage of EBA was much more dispersed, and no sin-

Figure 9.2 Sector of respondents indicating that 'taking advantage of AGOA' was a crucial factor for investment

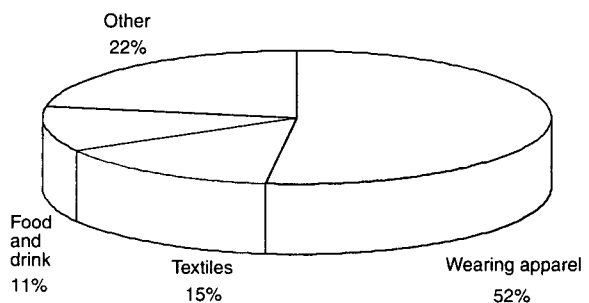

gle sector stood out as benefiting most from this agreement. Among the sectors that indicated the agreement was crucial to their investment decision were agriculture and tobacco, wood, pulp and paper products, other chemical products (including rubber and plastics products), food and drink and textiles.

These findings for AGOA, both in relation to origin and sector, are being confirmed by the widely known AGOA success stories in South Africa, e.g. Lesotho, where over 30,000 jobs have been created by mainly Asian firms producing textiles and garments for the United States market.

Conclusions

The first findings from this survey regarding the impact of trade agreements on attracting and retaining FDI in sub-Saharan Africa seem to suggest that AGOA in particular is attracting new foreign investment to the region. In absolute numbers, this group is still very small compared to the total foreign investor population, but is clearly growing in the case of AGOA.

For a relatively large group of existing investors that were already present in the region before these agreements came into force, either EBA or AGOA were considered important for their investment. This could imply that these agreements also benefit the survey region indirectly in terms of the increased opportunities offered to the investors as a result of new trade agreements. This could lead to investors reinforcing existing investment commitments to the region.

¹³ Integrating the Least Developed Countries into the World Trading System: The Current Impact of EU Preferences under Everything But Arms, Paul Brenton, 2003 (International Trade Department - The World Bank)

However, the total investment value and jobs created by these investors are still insignificant given the overall capital investment and employment situation in sub-Saharan Africa. In addition, there is no evidence in the survey that these agreements are generating substantial inflows of investment from the EU or United States. United States companies, in

particular, are largely absent in the survey, whereas United States companies are typically among the leading investors in any region around the world. One of the challenges of AGOA for sub-Saharan countries is to leverage the opportunities offered by the agreement and increase United States investment in the region

Case of a typical AGOA driven foreign investor

Company X was established in 2002 in Nairobi, Kenya to manufacture and export wearing apparel for the North American market. The Asian company entered the country as a wholly owned greenfield investment. The company employs around 750 people, including almost 20 expatriates. The current value of the investment amounts to approximately US\$ 3 million.

Local and regional markets or trade agreements were of no importance to the company since all sales are generated from exports to the United States and Canada. At the time of establishment, the company had evaluated several other location options, including Madagascar, Viet Nam and Bangladesh. Crucial factors driving the final decision in favor of Kenya were the opportunity to take advantage of AGOA, political stability and perceived low labour costs. Other factors considered important, but less crucial, were economic stability, regional market opportunities, availability of

skilled labour, raw materials, local suppliers and also incentives offered by the local government.

The company was initially made aware of the investment opportunities in Kenya through a briefing on objectives of AGOA and what it all means for companies. During the pre-investment phase the company had sought support from the IPC. Particular areas of where support was needed were information on doing business in the country, cost of doing business and import and export regulations. Furthermore the company required assistance with environmental impact assessment and finding suitable sites. The majority of these services were provided well, but the company felt that especially the services related to their request for information on doing business and cost of doing business in the country could be improved. Nonetheless, the overall evaluation by the company of the business conditions in the country and the expertise and support provided by IPC were perceived as attractive, and led to the investment in 2002.

Appendix I. Questionnaire

A. Profile of the company and operations in the country

1. What is the main business activity of your company in <<country>>?
2. Which business sectors most apply to this operation?
3. Please provide a brief description of the products or services provided at this operation.
4. Is your product a finished product or semi-finished product?
5. Year of establishment of this operation?
6. Mode of entry in the country: Joint venture, New Greenfield, Merger or Acquisition? Please provide rationale for this mode of entry.
7. Ownership Structure.
8. Level of initial capital investment in US\$ at time of entry.
9. Value of current investment in <<country>>.
10. Current number of employees at company in <<country>> How many of these employees are expatriates?
11. Current annual sales in your country, in sub-Saharan Africa and globally?
12. What was the approximate % increase in total annual sales compared to the previous fiscal year?
13. If your company has regional sales, which of the following trade agreement(s) play an important role?
14. What are the top 3 country destinations of your exports?

B. Motivation for original establishment or recent major new investment

15. Please check a box for the option that best describes your company's situation:
 1. Company has been established in <<country>> after 1995.
 2. Company was established before 1995 with no major new investment since.
 3. Company was established before 1995 with a major new investment since.
 4. Other, please describe.
16. At time of establishment, if you considered other countries for your investment, which were those countries?
17. Why did you choose to invest in <<country>>?
18. How was your company originally made aware of investment opportunities in <<country>>? (Please tick the most important box only).

C. Investment and operating experience in <<Country>> and with <<IPA>>.

19. Has your company been registered or provided with a certificate by the <<IPA>>?
If you answered Yes, how efficient was the certification process?
20. How useful was the <<IPA>> certificate or registration in actually obtaining taxation and other benefits?
21. What services did you request/need from the <<IPA>> before you decided to invest in <<country>>?
22. What services, if any, did your company request/avail from the <<IPA>> during and after establishing your business in <<country>>?
23. Which of the following incentives do you consider to be important and how easy are they to obtain?
24. Please give your views on the level of expertise of the <<IPA>> executive(s) who advised you on your investment in <<country>>.
25. What are the top three improvements you suggest the <<IPA>> make to their services?
26. Has the <<IPA>> performed to expectations in the last three years?
27. Has your investment in <<country>> performed to expectations in the last three years?
28. What are the main reasons for your answer to the previous question?

D. Economic impact in <<country>>

29. What is the total manufacturing value added (MVA) of goods produced in <<country>>, last year in US\$?
30. What is the total amount of annual wages you pay in <<country>>?
31. What is the approximate number of training days provided by your company to all employees (including days financed by your company) in the last year?
32. What % of your inputs/supplies is sourced within <<country>>? (% of value of final product).
33. What amount was invested in local research and development activities last year? (as a % of annual sales, including product or process improvements).
34. With which of the following local organisations in <<country>> has your company had or continues to have a relationship?
35. What percentage of your annual sales of goods or services are for exports?
36. For your current operations, what sales growth do you expect per annum over the next three years? (Country, sub-Saharan Africa, Global).
37. For your current operations, what change in employment do you expect over the next three years in <<country>>?
38. What level of new (i.e. in addition to depreciation replacement) investment are you planning to make over the next three years in <<country>>?
39. If considering a new investment, what would be its main purpose?
40. What are the three most important services you would like to receive from the <<IPA>> to help you realize this new investment in <<country>>?

F. Additional questions

41. If you were not currently located in <<country>> and still have the freedom to decide on the optimal location of your current operations, what would be your preferred location today for investments to serve African markets?
42. Please give the main reasons for your answer in Question 41 (Please use block capitals).
43. What would be your top three requirements from the host country to facilitate this new investment?

Closing questions

44. Would you like to be contacted by the <<IPA>> to discuss your investment in <<country>>?
45. Do you wish to give your permission for the information in the questionnaire to be provided to <<IPA>>?
46. Would you be interested in receiving a summary of the results of this study?

Annex II. Sector categories

Agriculture & tobacco	Agriculture, Hunting and Forestry Tobacco products
Food and drink	Food and drink
Textiles	Textiles
Wearing apparel	Wearing apparel and fur
Leather products and footwear	Leather products and footwear
Wood, pulp and paper products	Wood and cork products (not furniture) Pulp, paper and paper products
Base chemicals	Base chemicals
Pharmaceuticals	Pharmaceuticals
Other chemical products	Other chemical products Rubber and plastic products
Non-metallic mineral products (stone, clay and glass)	Non-metallic mineral products (stone, clay and glass)
Basic metals	Basic metals
Metal products	Fabricated metal products (except machinery and equipment)
Machinery	Machinery n.e.c. Office, accounting and computing machinery Electrical machinery
Transport equipment	Motor vehicles and equipment Other transport equipment
Furniture & other manufacturing	Furniture and other manufacturing n.e.c.
Transport and storage	Transport and storage
Financial Intermediation	Financial Intermediation (including insurance)
Other services	Wholesale and retail trade and motor vehicle etc. Repair Hotels and restaurants Post and Telecommunications Software and Computer Related Activities (including consultancy)
Other sectors	Mining Publishing and printing and recording reproductions Coke and refined petroleum products Electronic equipment (radio, TV and communications) Electronic components (includes semiconductors) Medical, precision and optical instruments, watches, clockes and instruments Recycling Electricity, Gas and Water Supply Construction

Annex III. Technology intensity of manufacturers

The classifications used in this report are based on those of OECD countries.

Resource-based manufacturers: mainly processed foods and tobacco, simple wood products, refined petroleum products, dyes, leather (not leather products), precious stones and organic chemicals. The products can be simple and labour-intensive (simple food or leather processing) or intensive in capital, scale and skills (petroleum refining or modern processed foods). Competitive advantage in these products generally – but not always – arises from the local availability of natural resources.

Low-tech manufacturers: mainly textiles, garments, footwear, other leather products, toys, simple metal and plastic products, furniture and glassware. These products tend to have stable, well-diffused technologies largely embodied in capital equipment, with low R&D expenditures and skill requirements and low economies of scale. Labour costs tend to be a major element of cost, and the products tend to be undifferentiated, at least at the mass-produced (non-fashion) end of the scale. Barriers to entry are relatively low; competitive advantages in these products – of interest to developing countries – come from price rather than quality or brand names.

Medium-tech manufacturers: heavy industry products such as automobiles, industrial chemicals, machinery and relatively standard electrical and electronic products. The products tend to have complex but not fast-changing technologies, with moderate levels of R&D expenditures but advanced engineering and design skills and large scales of production. In engineering products there is emphasis on product design and development capabilities as well as extensive supplier and subcontractor networks. Barriers to entry tend to be high because of capital requirements and strong learning effects in operation, design and (for some products) product differentiation. Innovation and learning in the engineering segment increasingly involves cooperation in the value chain between manufacturers, suppliers and sometimes customers (for large items of equipment).

High-tech manufacturers: complex electrical and electronic (including telecommunications) products, aerospace, precision instruments, fine chemicals and pharmaceuticals. These products, with advanced and fast-changing technologies and complex skill needs, have the highest entry barriers. The most innovative ones call for large R&D investment, advanced technology infrastructure and close interaction between firms, universities and research institutions. But many activities, particularly in electronics, have final processes with simple technologies, where low wages can be an important competitive factor. The high value-to-weight ratio (for example, electronics products have a higher unit value relative to their weight than automotive products) of these products allows segments of the value chain to be broken up and located across long distances.

FOREIGN DIRECT INVESTOR PERCEPTIONS IN SUB-SAHARAN AFRICA

Technological classification of products according to SITC revision 2

Resource based: 01 (excl. 011), 023, 024, 035, 037, 046, 047, 048, 056, 058, 06, 073, 098, 1 (excl. 121), 233, 247, 248, 25, 264, 265, 269, 323, 334, 335, 4, 51, 51 (excl. 512 and 513), 52 (excl. 524), 53 (excl. 533), 551, 592, 62, 63, 641, 66 (excl. 665 and 666), 68

Low tech: 61, 642, 65 (excl. 653), 665, 666, 67 (excl. 671, 672 and 678), 69, 82, 83, 84, 85, 89 (excl. 892 and 896)

Medium tech: 266, 267, 512, 513, 533, 55 (excl. 551), 56, 57, 58, 59 (excl. 592), 653, 671, 672, 678, 711, 713, 714, 72, 73, 74, 762, 763, 772, 773, 775, 78, 79 (excl. 792), 81, 872, 873, 88 (excl. 881), 95

High tech: 524, 54, 712, 716, 718, 75, 761, 764, 77 (excl. 772, 773 and 775), 792, 871, 874, 881

Source: UNIDO Industrial development report 2002/2003.

Annex IV: Tables

Table A. Distribution of respondents by sector and origin of the parent (percentage)

	<i>Europe</i>	<i>Middle East</i>	<i>Asia</i>	<i>America</i>	<i>Africa</i>	<i>Mixed</i>	<i>Total</i>
Agriculture and tobacco	55	5	12	7	21	0	100
Food and drink	40	4	11	8	36	1	100
Textiles	27	0	20	0	53	0	100
Wearing apparel	14	4	39	0	39	4	100
Leather and footwear	38	13	25	0	25	0	100
Wood, pulp and paper prod.	46	4	0	8	42	0	100
Base chemicals	50	0	13	13	13	13	100
Pharmaceuticals	67	0	11	11	11	0	100
Other chemical prod. (incl rubber & plastics products)	24	7	15	13	39	2	100
Non-metallic mineral products	53	7	7	0	20	13	100
Basic metals	55	9	18	0	18	0	100
Metal products	29	4	7	4	57	0	100
Machinery	43	7	14	7	25	4	100
Transport equipment	27	0	27	7	40	0	100
Furniture & other manufacturing	10	10	0	10	70	0	100
Transport and storage	52	5	10	10	19	5	100
Financial intermediation	52	0	10	14	24	0	100
Other services	38	6	15	2	38	2	100
Other sectors	48	5	16	5	25	2	100
Total	40	5	14	6	33	2	100

FOREIGN DIRECT INVESTOR PERCEPTIONS IN SUB-SAHARAN AFRICA

Table B. Total manufacturing value added of goods produced in the country (US\$)
(k=thousand, m=million, bn=billion)

	Less than 100k	100k- 500k	500k- 1m	1m- 5m	5m- 10m	10m- 25m	25m- 50m	50m- 100m	100m- 200m	200m- 500m	500m- 750m	750m- 1bn	more than 1bn
Agriculture and tobacco	8	1	4	10	2	4	2	1	1	1	0	0	0
Food and drink	14	10	10	16	3	3	3	3	1	1	1	0	5
Textiles	4	4	0	5	1	0	1	0	0	0	0	0	1
Wearing apparel	7	7	5	6	2	0	0	1	0	0	1	1	0
Leather and footwear	1	1	3	0	0	0	1	0	0	0	0	1	0
Wood, pulp and paper products	7	6	2	4	0	1	1	0	0	2	1	1	0
Base chemicals	1	1	1	1	0	0	0	0	0	0	0	1	0
Pharmaceuticals	1	2	2	1	1	0	1	0	0	0	0	0	0
Other chemical prod. (incl. rubber and plastics products)	8	10	11	10	3	2	3	0	1	1	1	0	1
Non-metallic mineral products	4	3	0	0	1	1	1	0	0	0	1	0	0
Basic metals	1	3	2	1	3	0	1	2	0	1	0	0	1
Metal products	9	10	2	9	1	0	0	0	0	1	0	0	1
Machinery	0	3	2	3	1	0	0	0	0	0	0	1	0
Transport equipment	2	2	2	1	1	0	2	0	0	0	0	0	0
Furniture and other manufacturing	4	5	1	1	0	1	1	0	0	1	0	0	0
Other sectors	4	4	1	5	1	1	1	3	1	0	0	1	0
Total	75	72	48	73	20	13	18	10	4	8	5	6	9
	20,8%	19,9%	13,3%	20,2%	5,5%	3,6%	5,0%	2,8%	1,1%	2,2%	1,4%	1,7%	2,5%

Table C. Total manufacturing value added of goods produced in the country (US\$)
(k=thousand, m=million, bn=billion)

	Less than 100k	100k- 500k	500k- 1m	1m- 5m	5m- 10m	10m- 25m	25m- 50m	50m- 100m	100m- 200m	200m- 500m	500m- 750m	750m- 1bn	more than 1bn
Agriculture and tobacco	8	1	4	10	2	4	2	1	1	1	0	0	0
Food and drink	14	10	10	16	3	3	3	3	1	1	1	0	5
Textiles	4	4	0	5	1	0	1	0	0	0	0	0	1
Wearing apparel	7	7	5	6	2	0	0	1	0	0	1	1	0
Leather and footwear	1	1	3	0	0	0	1	0	0	0	0	1	0
Wood, pulp and paper products	7	6	2	4	0	1	1	0	0	2	1	1	0
Base chemicals	1	1	1	1	0	0	0	0	0	0	0	1	0
Pharmaceuticals	1	2	2	1	1	0	1	0	0	0	0	0	0
Other chemical products (incl. rubber and plastics products)	8	10	11	10	3	2	3	0	1	1	1	0	1
Non-metallic mineral products	4	3	0	0	1	1	1	0	0	0	1	0	0
Basic metals	1	3	2	1	3	0	1	2	0	1	0	0	1
Metal products	9	10	2	9	1	0	0	0	0	1	0	0	1
Machinery	0	3	2	3	1	0	0	0	0	0	0	1	0
Transport equipment	2	2	2	1	1	0	2	0	0	0	0	0	0
Furniture and other manufacturing	4	5	1	1	0	1	1	0	0	1	0	0	0
Other sectors	4	4	1	5	1	1	1	3	1	0	0	1	0
	20,8%	19,9%	13,3%	20,2%	5,5%	3,6%	5,0%	2,8%	1,1%	2,2%	1,4%	1,7%	2,5%

Table D. Percentage of respondents exporting more than 75% of annual sales, per country and per sector

	Burkina Faso	Cameroon	Ethiopia	Kenya	Madagascar	Mozambique	Nigeria	Senegal	Tanzania, UR of	Uganda	Total
Agriculture and tobacco	0 0%	3 60%	3 38%	9 90%	4 80%	6 60%	0 0%	0 0%	1 25%	2 18%	28 49%
Food and drink	0 0%	2 15%	1 11%	0 0%	4 50%	2 20%	0 0%	1 20%	4 15%	1 5%	15 13%
Textiles	1 100%	0 0%	0 0%	0 0%	5 71%	0 0%	0 0%	0 0%	1 25%	0 0%	7 29%
Wearing apparel	0 0%	0 0%	0 0%	9 100%	21 95%	2 67%	0 0%	0 0%	1 25%	0 0%	33 77%
Leather and footwear	0 0%	1 100%	1 100%	0 0%	0 0%	0 0%	1 50%	0 0%	0 0%	0 0%	3 30%
Wood, pulp and paper prod.	0 0%	5 71%	0 0%	0 0%	1 25%	0 0%	0 0%	0 0%	0 0%	0 0%	6 15%
Base chemicals	0 0%	0 0%	0 0%	0 0%	0 0%	0 0%	0 0%	0 0%	0 0%	0 0%	0 0%
Pharmaceuticals	0 0%	0 0%	0 0%	1 20%	0 0%	0 0%	0 0%	0 0%	0 0%	0 0%	1 6%
Other chemical products (incl. rubber and plastics products)	0 0%	0 0%	0 0%	0 0%	1 17%	0 0%	0 0%	0 0%	0 0%	0 0%	1 1%
Non-metallic mineral products	0 0%	1 50%	1 33%	1 33%	1 100%	0 0%	1 33%	0 0%	0 0%	0 0%	5 20%
Basic metals	0 0%	0 0%	1 25%	0 0%	0 0%	1 50%	0 0%	0 0%	0 0%	0 0%	2 11%
Metal products	0 0%	0 0%	0 0%	0 0%	0 0%	0 0%	0 0%	0 0%	0 0%	0 0%	0 0%
Machinery	0 0%	0 0%	0 0%	0 0%	0 0%	0 0%	0 0%	0 0%	0 0%	0 0%	0 0%
Transport equipment	0 0%	0 0%	0 0%	0 0%	1 33%	0 0%	0 0%	0 0%	0 0%	0 0%	1 5%
Furniture and other manufacturing	0 0%	0 0%	1 100%	0 0%	1 33%	0 0%	0 0%	0 0%	0 0%	0 0%	2 11%
Transport and storage	1 25%	0 0%	0 0%	1 20%	2 67%	0 0%	0 0%	0 0%	1 100%	0 0%	5 19%
Financial intermediation	0 0%	0 0%	0 0%	0 0%	0 0%	0 0%	0 0%	0 0%	0 0%	0 0%	0 0%
Other services	0 0%	0 0%	0 0%	1 14%	1 14%	0 0%	0 0%	1 17%	1 14%	0 0%	4 5%
Other sectors	1 14%	0 0%	0 0%	1 8%	0 0%	1 9%	0 0%	0 0%	1 25%	1 25%	5 8%
Total	3 6%	12 20%	8 15%	23 25%	42 53%	12 13%	2 2%	2 5%	10 10%	4 4%	118 16%

FOREIGN DIRECT INVESTOR PERCEPTIONS IN SUB-SAHARAN AFRICA

Table E. Distribution of foreign investors by company employment size (percentage)

	Burkina Faso	Cameroon	Ethiopia	Kenya	Madagascar	Mozambique	Nigeria	Senegal	Tanzania, UR of	Uganda	Total
1 to 10	8	13	15	4	6	19	4	5	4	7	8
11 to 50	40	17	31	22	18	35	23	37	34	30	28
51 to 100	23	20	19	17	16	19	20	29	23	21	20
101 to 250	17	23	12	17	20	11	24	16	17	24	18
251 to 500	13	10	13	17	20	9	18	8	8	7	12
501 to 1000	0	7	0	9	13	3	9	0	8	3	6
1001 to 2000	0	3	6	9	7	2	1	0	5	4	4
more than 2000	0	7	4	6	0	2	1	5	1	2	3
Total	100	100	100	100	100	100	100	100	100	100	100

Table F. Distribution of foreign investors by expected employment growth (percentage)

	Burkina Faso	Cameroon	Ethiopia	Kenya	Madagascar	Mozambique	Nigeria	Senegal	Tanzania, UR of	Uganda	Total
reduce >40%	2	0	2	0	4	0	1	0	1	0	1
reduce 20-40%	0	2	0	2	3	1	1	0	0	2	1
reduce <20%	4	16	7	19	10	15	8	0	10	6	10
Total reducing	6	18	9	21	17	16	10	0	11	9	13
no change	47	43	24	42	31	39	24	42	24	32	34
Total no change	47	43	24	42	31	39	24	42	24	32	34
growth <20%	38	38	37	26	37	26	49	50	46	51	39
growth 20-40%	9	2	24	9	10	14	13	8	14	6	11
growth >40%	0	0	7	2	5	5	4	0	5	2	3
Total growth	47	39	67	37	53	45	65	58	65	59	53
Total	100	100	100	100	100	100	100	100	100	100	100

Table G. Distribution of respondents by value of current investment (percentage)
(US\$; k=thousand; m=million)

	Burkina Faso	Cameroon	Ethiopia	Kenya	Madagascar	Mozambique	Nigeria	Senegal	Tanzania, UR of	Uganda	Total
less than 100k	13	17	4	5	14	17	1	6	2	3	8
100-500k	13	11	12	7	18	32	11	21	13	13	15
500k-1m	16	13	12	10	25	14	8	12	14	16	14
1m-5m	36	17	33	27	25	16	21	42	36	22	26
5m-10m	13	6	17	13	8	7	13	3	9	20	11
10m-25m	2	17	13	7	8	2	19	6	10	5	9
25m-50m	4	4	4	5	0	2	5	6	5	4	4
more than 50m	2	15	6	27	1	10	21	3	10	16	12
Total	100	100	100	100	100	100	100	100	100	100	100

FOREIGN DIRECT INVESTOR PERCEPTIONS IN SUB-SAHARAN AFRICA

Table H. Distribution of foreign investors by percentage sales increase compared to the previous fiscal year (percentage)

	Falling sales	No growth	Sales increased by 1 to 3%	Sales increased by 4 to 7%	Sales increased by 8 to 12%	Sales increased by 13 to 20%	Sales increased with more than 20%	Total
Agriculture and tobacco	20	9	9	9	17	3	34	100
Food and drink	12	12	8	13	13	11	29	100
Textiles	27	13	0	7	7	20	27	100
Wearing apparel	15	12	0	4	15	15	38	100
Leather & footwear	33	0	17	0	17	33	0	100
Wood, pulp and paper prod.	6	16	13	10	10	19	26	100
Base chemicals	0	38	13	13	13	0	25	100
Pharmaceuticals	0	25	17	0	0	50	8	100
Other chemical products (incl. rubber and plastics products)	7	3	14	9	24	14	29	100
Non-metallic mineral products	10	20	5	5	15	20	25	100
Basic metals	14	14	14	0	0	21	36	100
Metal products	3	6	9	18	12	24	27	100
Machinery	7	19	4	15	15	11	30	100
Transport equipment	15	0	5	20	20	15	25	100
Furniture and other manufacturing	20	10	20	10	20	10	10	100
Transport and storage	4	4	13	4	26	13	35	100
Financial intermediation	12	16	4	12	16	16	24	100
Other services	8	17	10	6	17	10	33	100
Other sectors	15	9	11	13	23	11	19	100
Total	11	12	9	10	16	14	28	100

Table I. Main countries of export

	Agriculture and tobacco	Food and drink	Textiles	Wearing apparel	Leather and footwear	Wood, pulp and paper products	Base chemicals	Pharmaceuticals	Other chemical products (incl. rubber and plastics products)	Non-metallic mineral products	Basic metals	Metal products	Machinery	Transport equipment	Furniture & other manufacturing	Transport and storage	Financial intermediation	Other services	Other sectors	Total
United States	7	7	2	27	1	0	0	0	2	2	0	0	1	1	1	6	0	2	0	59
Uganda	0	6	0	0	1	2	3	2	12	4	1	3	1	3	1	3	1	1	4	48
France	8	7	3	12	1	6	0	0	1	1	0	0	0	0	1	1	3	5	0	49
Tanzania, UR of	2	5	1	0	0	1	3	1	11	2	0	3	2	3	0	1	0	2	5	42
Kenya	2	15	0	0	1	2	1	0	6	1	1	1	0	1	0	1	1	4	1	38
Rwanda	2	4	2	0	0	6	0	0	7	1	2	3	1	3	0	1	0	0	2	34
Mali	1	2	0	0	1	2	1	0	6	1	0	3	2	3	1	0	0	2	2	27
United Kingdom	9	3	0	6	0	2	0	0	0	0	0	0	0	0	0	4	0	1	2	27
Congo	0	6	1	0	2	3	0	0	3	0	2	3	0	1	0	1	0	0	1	23
South Africa	1	8	0	2	0	0	0	0	2	2	0	3	0	0	0	0	0	3	2	23
Niger	0	1	2	0	1	2	0	0	4	0	0	3	1	2	2	0	0	0	0	18
Germany	7	4	1	1	0	1	0	0	0	1	0	0	1	0	0	1	0	0	0	17
Spain	4	3	2	2	2	2	0	0	1	0	0	0	0	0	0	0	0	0	0	16
Italy	2	2	0	0	2	4	0	0	0	3	0	0	0	0	1	0	1	0	0	15
Malawi	2	3	0	1	2	1	0	0	0	0	2	1	0	0	0	1	0	0	1	14



UNITED NATIONS INDUSTRIAL DEVELOPMENT ORGANIZATION
Vienna International Centre, P.O. Box 300, A-1400 Vienna, Austria
Telephone: (+43 1) 26026-0, Fax: (+43 1) 26926 69
E-mail: unido@unido.org Internet: <http://www.unido.org>